

# IPM for Schools: A How-to Manual



# **IPM for Schools: A How-to Manual**

Authors

Sheila Daar, Tanya Drlik,  
Helga Olkowski, William Olkowski

Editor

Tanya Drlik

Editorial Assistant

Aloysha Ricards

Project Director

Sheila Daar

A Bio-Integral Resource Center Publication  
BIRC  
P.O. Box 7414  
Berkeley, CA 94707



## Acknowledgments

Roger Akre, Michael Baefsky, Joelle Bouchard,  
Doug Carver, Stephen Frantz, Cynthia Hsu,  
Irene Juniper, William Quarles, Sarah Schubart,  
Laurie Swiadon, Robert L. Smith, Kathy Spaulding,  
Pamela Weatherford, and Michael Wolf.

Desktop Publishing by Lisa Krieshok Design

## Disclaimer

Mention of trade names, products, or  
services does not convey, and should not  
be interpreted as conveying, approval,  
endorsement, or recommendation.

This manual was written by the Bio-Integral Resource Center in March 1997.  
Partial funding was provided by USEPA.

---

# TABLE OF CONTENTS

Introduction.....	1
<b>Chapter 1 What Is Integrated Pest Management?.....</b>	<b>3</b>
The Role of Pesticides in School IPM.....	3
IPM Program Goal .....	3
Components of an IPM Program .....	4
The Decision-Making Process .....	5
Bibliography .....	8
<b>Chapter 2 Monitoring.....</b>	<b>9</b>
Not Enough Time or Money? .....	9
Levels of Effort Used in Monitoring .....	9
What is Monitoring? .....	9
Why Monitor? .....	9
What to Monitor .....	10
Identifying the Target Pest .....	11
Timing Monitoring Activities .....	11
Record Keeping .....	13
Bibliography .....	14
<b>Chapter 3 Setting Injury and Action Levels.....</b>	<b>15</b>
Determine Injury Levels First .....	15
Determine Action Levels Based on Injury Levels .....	16
IPM Program Evaluation .....	16
Assessing Cost Effectiveness .....	18
Bibliography .....	18
<b>Chapter 4 Selecting Treatment Strategies.....</b>	<b>19</b>
Criteria For Selecting Treatment Strategies .....	19
Timing Treatments .....	20
Summary of Available Treatment Options .....	20
Education .....	21
Habitat Modification .....	21
Modification of Horticultural Activities .....	21
Physical Controls .....	21
Biological Controls .....	22
Least-Toxic Chemical Controls .....	23
Bibliography .....	26
<b>Chapter 5 IPM for Ants in Schools.....</b>	<b>27</b>
Identification and Biology .....	27
Damage .....	27
Detection and Monitoring.....	27
Management Options.....	28
Bibliography .....	33

---

<b>Chapter 6 IPM for Cockroaches in Schools.....</b>	<b>35</b>
Identification and Biology .....	35
Damage .....	35
Detection and Monitoring .....	35
Management Options.....	41
Bibliography .....	48
<b>Chapter 7 IPM for Clothes Moths and Carpet Beetles in Schools.....</b>	<b>49</b>
Identification and Biology .....	49
Damage .....	50
Detection and Monitoring .....	52
Management Options.....	53
Bibliography .....	55
<b>Chapter 8 IPM for Fleas in Schools.....</b>	<b>57</b>
Identification and Biology .....	57
Damage .....	57
Detection and Monitoring .....	57
Management Options.....	58
Bibliography .....	61
<b>Chapter 9 IPM for Flies in Schools.....</b>	<b>63</b>
Garbage- and Manure-Breeding Flies	
Identification and Biology .....	63
Damage .....	63
Detection and Monitoring .....	63
Management Options.....	63
Fruit Flies, Cluster Flies, and Phorid Flies	
Identification and Biology .....	69
Management Options.....	69
Bibliography .....	70
<b>Chapter 10 IPM for Lawns in Schools.....</b>	<b>71</b>
Detection and Monitoring .....	71
Management Options.....	74
Chinch Bugs	
Identification and Biology .....	76
Damage .....	76
Detection and Monitoring .....	76
Management Options.....	77
Fusarium Blight	
Identification and Biology .....	78
Management Options.....	78
Bibliography .....	79
<b>Chapter 11 IPM for Head Lice in Schools.....</b>	<b>81</b>
Identification and Biology .....	81

---

How Lice are Transmitted .....	81
Damage .....	81
Detection and Monitoring.....	81
Management Options.....	82
Bibliography .....	85
<b>Chapter 12 IPM for Rats and Mice in Schools.....</b>	<b>87</b>
Identification and Biology .....	87
Damage .....	89
Detection and Monitoring.....	89
Management Options.....	91
Bibliography .....	102
<b>Chapter 13 IPM For Scorpions in Schools.....</b>	<b>103</b>
Identification and Biology .....	103
Stings .....	103
Detection and Monitoring.....	104
Management Options.....	104
Bibliography .....	105
<b>Chapter 14 IPM for Silverfish, Firebrats, and Booklice in Schools.....</b>	<b>107</b>
Identification and Biology .....	107
Damage .....	108
Detection and Monitoring.....	108
Management Options.....	108
Bibliography .....	110
<b>Chapter 15 IPM for Spiders in Schools.....</b>	<b>111</b>
Removal of a Non-Dangerous Spider.....	111
General Spider Management .....	111
Black Widow Spiders	
Identification and Biology .....	111
Bites .....	112
Detection and Monitoring.....	112
Management Options.....	112
Brown Recluse or Violin Spiders	
Identification and Biology .....	113
Bites .....	113
Detection and Monitoring.....	114
Management Options.....	114
Aggressive House Spider	
Identification and Biology .....	114
Bites .....	114
Detection and Monitoring.....	114
Management Options.....	114
Bibliography .....	115

---

<b>Chapter 16 IPM for Trees and Shrubs on School Grounds</b> .....	117
Plant Health Care (PHC) Management .....	117
Components of a PHC Program .....	117
Conclusion .....	119
Bibliography .....	119
<b>Chapter 17 IPM for Wood Damaging Pests in Schools</b> .....	121
Identification and Biology—Wood-Attacking Fungi .....	121
Identification and Biology—Termites .....	121
Identification and Biology—Wood-Boring Beetles .....	124
Detection and Monitoring .....	126
Management Options.....	130
Bibliography .....	136
<b>Chapter 18 IPM for Weeds on School Grounds</b> .....	139
Identification and Biology .....	139
Detection and Monitoring .....	140
Management Options.....	141
Bibliography .....	143
<b>Chapter 19 IPM for Yellowjackets and Hornets in Schools</b> .....	145
Identification and Biology .....	145
Stings .....	145
Nest Disturbance .....	147
Detection and Monitoring .....	147
Management Options.....	148
Bibliography .....	152
Recommended Reading List.....	153
Appendix A    IPM-Related Curricula and Resources for the Classroom.....	157
Appendix B    How to Develop an IPM Program.....	159
Appendix C    Developing an IPM Policy Statement.....	169
Appendix D    IPM Contract Performance Specifications.....	171
Appendix E    Sample Monitoring Forms.....	177
Appendix F    How To Collect and Preserve Specimens for Identification.....	195
Appendix G    Pesticide Information Resources.....	197
(includes Directory of Least-Toxic Pest Control Products)	
Appendix H    Head Lice Information Packet for Schools.....	201
Appendix I    Inspection Checklist for Detecting Structural Decay and Structural Pest Damage.....	211

---

# INTRODUCTION

## PEST MANAGEMENT CHALLENGES IN THE SCHOOL ENVIRONMENT

Use of Integrated Pest Management (IPM) principles and practices in the school environment is a growing trend in communities throughout the United States. IPM's focus on pest prevention using effective, least-toxic methods is proving practical to apply and cost-effective to operate.

As Maryland school IPM expert William Forbes (and others) have pointed out, a school is a challenging place to operate a pest management program. Most school buildings are unintentionally designed with ideal entry points and harborage for pest insects, rodents, and other unwelcome wildlife. Inappropriate landscape design and plant selection often encourage weeds and other pest problems. Diminishing budgets and deferred maintenance exacerbate these predisposing conditions for pests.

Schools also include diverse physical spaces, indoors and out, that require customized solutions to pest problems. In addition, schools host a wide variety of people, from teachers and students to vendors and community groups, who have differing opinions about pest tolerance levels and appropriate pest management methods. It is necessary to sensitively address the concerns of parents and others who want a school site free of nuisance or health-threatening pests, but want this achieved with minimal use of toxic materials.

Because IPM is a decision-making process and not a rote method, an IPM program will always be able to

take into account the wide spectrum of pest problems and the diversity of people involved. IPM methods equip pest control operators (PCOs) and other members of the IPM team to design flexible, site-specific pest management plans scaled to the severity of the problem and the level of resources available.

The IPM approach also offers unique opportunities to incorporate pest management issues into the school science curriculum and offer students hands-on learning experiences in the biology, ecology, and least-toxic management of the pests that seek to inhabit school buildings and grounds (see Appendix A for a listing of IPM-related curricula).

Chapters 1 through 4 provide a full discussion of IPM concepts pertaining to schools. These chapters will be of particular interest to school board members, administrators, principals, facility managers, and parents as they work to establish IPM policies, pest control contract guidelines, and other administrative systems designed to institutionalize IPM.

Appendix B, "How To Develop An IPM Program," provides a step-by-step guide for implementing a school IPM program, and includes a discussion of the psychological and institutional barriers to IPM.

Chapters 5 through 19 cover IPM strategies for 14 of the most common pests or problem sites in U.S. schools. These chapters are written primarily for pest control personnel and others who may be involved in the day-to-day pest management in a school.





---

# CHAPTER 1

## WHAT IS INTEGRATED PEST MANAGEMENT?

Integrated pest management (IPM) is an approach to pest control that utilizes regular monitoring and record keeping to determine if and when treatments are needed, and employs a combination of strategies and tactics to keep pest numbers low enough to prevent unacceptable damage or annoyance. Biological, cultural, physical, mechanical, educational, and chemical methods are used in site-specific combinations to solve the pest problem. Chemical controls are used only when needed, and in the least-toxic formulation that is effective against the pest. Educational strategies are used to enhance pest prevention, and to build support for the IPM program.

### THE ROLE OF PESTICIDES IN SCHOOL IPM

Although pesticides often have a role to play in IPM programs for schools, their use should be approached with caution. The risk of harm from exposure to pesticides is relatively higher for infants and children than for adults exposed at the same levels (National Research Council 1993 [see Box 1-A]). By using the least-toxic product effective against the pest and applying it as a spot treatment in combination with non-chemical methods such as pest-proofing and improved sanitation, risks from pesticide exposure can be minimized.

The term “least-toxic” refers to pesticides that have low or no acute or chronic toxicity to humans, affect a narrow range of species, and are formulated to be applied in a manner that limits or eliminates exposure of humans and other non-target organisms. Fortunately, there are an increasing number of pesticides that fit within this “least-toxic” definition. Examples include products formulated as baits, pastes, or gels which do not volatilize in the air and which utilize very small amounts of the active ingredient pesticide, and microbial pesticides formulated from fungi, bacteria, or viruses that are only toxic to specific pest species but harmless to humans.

### IPM PROGRAM GOAL

The goal of a school IPM program is to protect human health by suppressing pests that vector diseases, to reduce losses from pest damage, reduce environmental pollution, reduce human exposure to pesticides, particularly that of children, and to reduce costs of

#### Box 1-A.

#### Special Vulnerabilities of Children to Pesticides

In 1993, the National Research Council, a committee of the National Academy of Sciences, published a report entitled *Pesticides in the Diets of Infants and Children*. This report documented that infants and children face relatively higher risks from exposure to pesticides than do adults exposed at the same levels. This is due to a number of physiological factors including the rapid growth and development of a child’s central nervous system that makes this young nervous system particularly vulnerable to exposure to neurotoxins, and the fact that children consume more food relative to their body weight, so their actual exposure levels are often higher than those of adults. The report also points out that children can be exposed to pesticides from non-dietary sources (e.g., residues from pesticides applied in the home, school, park, etc.), and that when residues of two or more pesticides are combined, synergistic action between the compounds can significantly increase their level of toxicity.

For many years, the Environmental Protection Agency (EPA) has evaluated the safety of pesticides largely on potential risks to healthy adults (Benbrook 1996), primarily males. However, in 1996, the 104th Congress unanimously passed the Food Quality Protection Act of 1996 which amends the Federal Insecticide, Fungicide, and Rodenticide Act (FIFRA) and the Food, Drug, and Cosmetic Act to require the EPA to take into account the special risks posed to infants and children (as well as pregnant women) when determining tolerance levels for pesticide residues in food. As a result, food tolerance levels are expected to drop significantly, and not all currently registered agricultural pesticides (many of which are also used in schools), will be able to meet the new criteria. How this will affect the availability of pesticides currently used in schools is not yet clear.

pest control. In IPM programs, treatments are not made according to a fixed schedule; they are made only when and where monitoring has indicated that the pest will cause unacceptable economic, aesthetic, or medical injury or damage.

“Economic injury” refers to damage to structures or plants severe enough to cause an economic loss. Examples of economic injury might be loss of food due to rodent or insect contamination, or severe structural damage due to moisture accumulation and wood-destroying fungi. “Aesthetic injury” refers to annoyance or embarrassment from visibility of a pest, or damage to the appearance of plants which may reduce aesthetic appeal but does not necessarily adversely affect plant health. The tolerance levels for aesthetic injury differ: the tolerance for weeds in lawns might be much higher in a school playground than in the front lawn or entryway to the school. “Medical injury” refers to illness in humans, pets, or wildlife caused by organisms or compounds transmitted by pests. Two examples of health-threatening pests are rodents which can carry diseases and poison oak or ivy which cause painful skin rashes.

In an IPM program, if treatments are needed, they are selected and timed to be most effective on the pest, least disruptive to its natural controls, and least hazardous to humans and the environment.

## COMPONENTS OF AN IPM PROGRAM

One of the characteristics of an IPM approach that makes it so effective is that the basic decision-making process is the same for any pest problem in any location. The strategies and tactics may change, but the steps taken to decide if and when treatment is needed, and which methods to use, are the same each time. Thus, the pest manager does not need to try to remember reams of pest control “recipes” for specific pests. Instead, it is an understanding of the components of an IPM program that must be mastered. The IPM decision-making process is illustrated in Figure 1-1.

An IPM program is built around the following components:

- monitoring the pest population and other relevant factors
- accurate identification of the pest
- determining injury and action levels that trigger treatments

- timing treatments to the best advantage
  - spot treating the pest (to minimize human and other non-target organism exposure to pesticides and to contain costs)
  - selecting the least-disruptive tactics
  - evaluating the effectiveness of treatments to fine-tune future actions
  - educating all people involved with the pest problem
- Each of these components is discussed in detail in later chapters of this manual.

Figure 1-1.  
**The IPM Decision-Making Process**

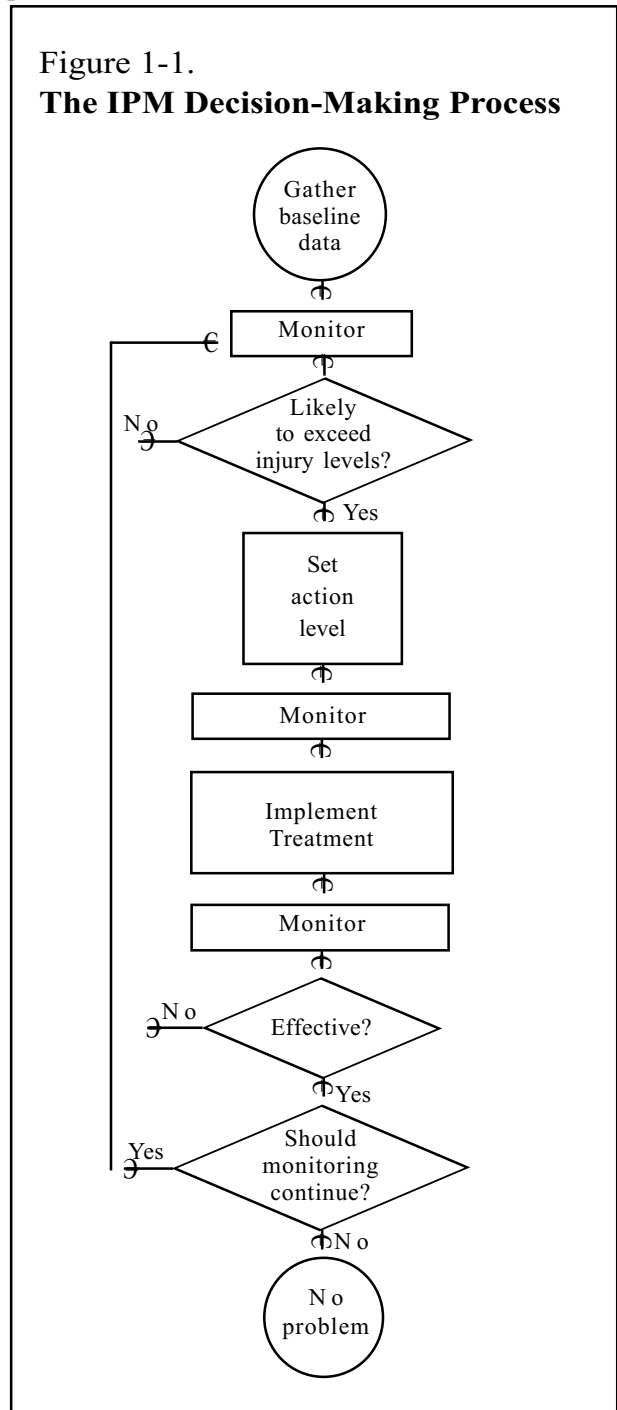

---

## THE DECISION-MAKING PROCESS

The basic IPM process helps answer four key pest management questions, easily remembered by four words: IF, WHERE, WHEN, and WHICH.

### IF treatment action is necessary

Instead of taking action at the first sign of a potential pest, the IPM process begins with asking whether any actions at all are needed (see Chapter 3 for a discussion of injury and action levels). Sometimes, even a fairly large population of pests can be tolerated without causing a problem. In other cases, the presence of a single pest organism is considered intolerable. In still other cases, what is considered a pest by one group in society may be considered innocuous by another.

Example: Boxelder bugs (*Leptocoris trivittatus*) are brightly colored and often cluster under shrubs, on the shady side of tree trunks, or enter buildings through open doors or broken window screens. The sight of them sometimes frightens people, or raises fears that they will damage plants. In fact, these insects are harmless. They feed mainly on boxelder trees and silver maples, and rarely harm even these trees since their main food source is the tree's seeds. Thus, concern about their presence is generally unwarranted.

Example: Large rodent droppings and grease trails suggest there is a rat in a crawl space under the eaves. Even one rat can be a problem, because it can gnaw on electric wires causing fires, and leave fleas which can transmit pathogens to humans. Treatment action is usually required even if only one rat is suspected.

### WHERE treatment activity should take place

If it is decided that some treatment action is necessary, the IPM process encourages pest managers to look at the whole system for the best place to solve the problem. Treatment should be applied where actions will have the greatest effect.

Example: Although mosquito problems are frequently handled by fogging buildings or school yards with insecticides, it is not possible to control mosquitoes unless treatment is directed at the immature stages of the insect. Mosquito larvae develop in water (e.g., clogged gutters and drains, stagnant ponds, low-spots in playing fields, etc.). By locating such sites and eliminating them or treating them with non-toxic microbial materials to kill the larvae, mosquito prob-

## IPM Is Federal Policy

In 1979, the Council on Environmental Quality (CEQ), an advisory body to the President, issued a report entitled Integrated Pest Management, which included recommendations that IPM be adopted as official policy in the United States. This new Federal policy was announced to the nation in the President's State of the Union address that year. It represented a significant shift in thinking about an appropriate approach to pest management for this country.

The new policy immediately influenced budget allocations and practice in Federal agencies such as the National Park Service, the Department of Agriculture, and the Environmental Protection Agency. During the following decades, state, county, and local public agencies, as well as arborists, landscapers, and nurseries began to adopt IPM as their standard.

The National Park Service (NPS) was the first federal agency to adopt an IPM policy and to implement IPM programs throughout the 70 million acres of lands and facilities then maintained by NPS. Within three years after adopting IPM system wide (1981-1983), NPS reduced pesticide use by over 70% (Johnston 1984).

In urban settings, IPM has been used to manage insect, pathogen, weed, and vertebrate pests in parks and gardens, on shade trees, in houses, apartments, office buildings, hospitals, restaurants, and at many other sites. The City of Berkeley, CA, used IPM to reduce pesticide use on municipal street trees by over 90%, saving the city \$22,500 in the first year of the IPM program (Olkowski et al. 1976).

School systems have also implemented IPM programs. Maryland's Montgomery County Public Schools have reported that their IPM program cut pest control costs by \$6,000 in the first three years of the program (Forbes 1991), and IPM improved overall pest control by substituting monitoring, education, sanitation, physical controls, and least-toxic pesticides in place of routine use of conventional chemical controls. This is far from an isolated example; schools and school districts in California, Oregon, Florida, Illinois, and elsewhere are adopting IPM and achieving a less-toxic environment for their teachers and students.

---

lems can be solved before mosquitoes become biting adults without exposing the school community to potentially hazardous pesticides.

### **WHEN action should take place**

The timing of treatments is important. Often there is an optimal time in the life cycle of the plant or the pest to apply control measures. Conversely, there may be times when treatments actually increase pest problems. The human social system will also affect the timing of treatments. The IPM process encourages managers to discover the best timing for treatment actions (see “Timing Treatments” in Chapter 4) since long-term success of any treatment depends on timing and locating it properly.

Example of timing in the life cycle of a plant: Rose powdery mildew (*Sphaerotheca pannosa*) usually infects only succulent young growth on roses. Because mature leaves are rarely attacked, treatments are only necessary when growth spurts occur, and only new foliage requires treatment.

Example of timing in the life cycle of the pest insect: BT (*Bacillus thuringiensis*) is a naturally occurring bacteria developed into a commercial insecticide to control caterpillar pests. It must be applied to leaves when caterpillars are small and actively feeding in order for them to consume the bacteria and die. If BT is applied when caterpillars are large, they may have already stopped eating in preparation for spinning cocoons.

Example of timing in the social system: When switching to IPM, it is essential to coordinate the IPM program plan with the overall budget process of the school district. For example, improving rodent and fly management may require modifications in food storage facilities or in the disposal of kitchen garbage. Substantial repair to windows or plumbing may be needed. Requesting funds for minor construction, new containers, etc. must be done at the appropriate time in the school district’s budget development process.

### **WHICH mix of strategies and tactics are the best to use**

There are three guiding principles to use when choosing treatments: conserve and enhance naturally occurring biological controls; use a multi-tactic approach; and view each pest problem in its larger context.

#### **Conserve and enhance naturally occurring biological controls**

In a landscape setting, when we kill the natural enemies of pests, we inherit their work. In many cases, the

combined action of all natural enemies present may result in substantial pest control. Even when they are not able to do the complete job, natural enemies are nonetheless providing some help in protecting school landscape plants from pest insects. The IPM program should be designed to avoid damaging natural enemies (see “Biological Controls” in Chapter 4 for more information).

Example: Many spider mite populations on various trees and shrubs are kept under control by naturally occurring predatory mites. In fact, the predators keep them under such good control we many never be aware of their presence until we spray a pesticide intended to kill more obvious pests, such as aphids. For a number of reasons, most pesticides are more harmful to the predatory mites than the pest mites. The pesticide kills almost all of the predators, the spider mites are only slightly affected, and now that they are free from their natural enemies, the pest mites quickly multiply and devastate the plant. By changing the tactics for controlling the aphids, a spider mite problem can be avoided.

#### **Use a multi-tactic approach**

Every source of pest mortality, no matter how small, is a valuable addition to the program. Biological systems are so complex, rarely will a single tactic, such as the application of a pesticide, solve the problem for long. As many non-toxic tactics as possible should be combined to manage the pest problem.

Example: Controlling cockroaches requires direct tactics such as applying boric acid dust to cracks, crevices, and wall voids; placing baits in areas inaccessible to students; using an insect-growth regulator and boric acid water washes in areas not in direct contact with food or people; and releasing parasitoids for certain roach species. But, long-term cockroach control must also include habitat modification such as caulking or painting closed cracks and crevices; screening vents that may be used by cockroaches to travel between adjacent areas; eliminating water leaks and cracks around plumbing fixtures; and improving the storage of food supplies and organic wastes.

#### **View each pest problem in its larger context**

Each pest problem must be considered within the framework of the larger system in which it has arisen. Textbooks and manuals commonly treat pest problems one by one. However, in the “real world” setting of a school and the grounds around it, pest problems occur several at a time or in a sequence in which management of one influences the others. In addition, pest problems are

---

influenced by other human activities such as waste disposal and food handling indoors, and mowing, fertilizing, and irrigating outdoors, as well as the attitudes of the many people who work and study within the district.

Using IPM means taking a “whole system” or ecosystem management approach to solving a pest problem. A successful IPM program considers all of the components of an ecosystem. As biologists and ecologists use the term, an ecosystem is usually thought of as containing non-living (abiotic) and living (biotic) components. For instance, if you consider a school building as an ecosystem, the abiotic components of the building would be the building itself and the equipment and furnishings within it. The biotic components would be the people, insects, spiders, etc. that live and work in the building.

In an IPM program, it is helpful to include another category—social/political components. In a school system this category includes teachers, students, custodians, grounds maintenance staff, food handlers, clerical staff, health personnel, carpenters, plumbers, pest control companies, refuse collectors, and other outside service providers who might be contracted for specific work in or around the school. The school district administration and school board, school neighbors or adjacent land owners, associated public agencies or institutions, professional associations and community groups, and the general public must be included. The political and legal constraints of the society at large should also be taken into consideration.

The many components of the school ecosystem can be thought of as a series of systems, each having an impact on the other, and all potentially impacted by a pest management program. To design and implement a successful IPM program, it is necessary, at least to some degree, to be aware of and obtain information from each of these components.

This raises the classic problem in systems management: where to draw the boundary of your system. If you draw the boundaries too narrowly and include only the pest, you may miss something important like the fact that people are leaving food out at night that feeds the pest. Generally speaking, it is better to read, question, and observe as much as possible about the larger system in which the pest problem exists. Otherwise, there is a risk that the solution to the pest problem will be overlooked.

Example: A nuisance fly problem inside the school may prompt use of space sprays or pesticide-impregnated plastic strips. A less toxic quick-fix might be to purchase

and install electric insect traps. A broader view could lead to the observation that some window screens need repair and could be improved by the addition of weather-stripping around the frames to exclude flies. A still larger view might include the observation that the dumpster out on the school grounds is inappropriately placed or not adequately cleaned after being emptied each week, thus attracting flies.

Changing these conditions will involve cooperation from the custodial and maintenance staff. Perhaps the dumpster needs to be moved a greater distance from the door. Perhaps more frequent removal and replacement of the dumpster may also be desirable. This will undoubtedly have budgetary consequences and will involve negotiations outside immediate school personnel. Ultimately it may be discovered that the flies are part of a community-wide problem. There may be little that can be done about this directly, but complaints from the school system to the local municipal government may help in ultimately changing area-wide waste management practices.

At first it may seem that there is little that a few individuals can do to influence the process of change in the larger ecosystem; however, the individual schools and the school district can assume a leadership role in educating their community about safer and more permanent methods of pest management. This can be done indirectly by educating the student population, and directly through the participation of school personnel in community forums on pest management-related matters.

## **IPM POLICY STATEMENT**

Schools districts will need to develop policy statements that set out how pest control will be performed. Appendix C contains a sample school pest management policy statement that can be modified to fit individual districts.

## **CONTRACT SPECIFICATIONS FOR PEST CONTROL COMPANIES**

Many schools will find it necessary to contract out all or some of their pest management. It is important to specify in the contract that IPM will be used and to list the requirements of such a program (Appendix D provides a sample contract). In some areas of the country, school districts have developed requirements for pest control firms that wish to contract with the school district (Raphael 1997). If pest control companies can fulfill these requirements, they can be included in a list of

---

possible bidders from which individual schools can choose. This prevents schools from contracting with pest control companies that although they may be the lowest bidder, may have little expertise in running an IPM program.

## **BIBLIOGRAPHY**

Benbrook, C., E. Groth, J.M. Halloran, M.K. Hansen, and S. Marquardt. 1996. *Pest Management at the Crossroads*. Consumers Union, Yonkers, NY. 272 pp.

Forbes, W. 1991. From spray tanks to caulk guns: successful school IPM in Montgomery County, MD. *Journal of Pesticide Reform* 10(4):9-11.

Johnston, G. 1984. Personal communication. IPM Coordinator, National Park Service.

National Research Council. 1993. *Pesticides in the Diets of Infants and Children*. National Academy Press, Washington, D.C.

Olkowski, W., et al. 1976. Ecosystem management: a framework for urban pest control. *Bioscience* 26(6):384-389.

Raphael, D. 1997. Personal communication. Environmental Analyst, Environmental Programs Division. 200 Santa Monica Pier, Suite 1, Santa Monica, CA 90401. (310) 458-2255.

# CHAPTER 2

## MONITORING

Monitoring is the backbone of an IPM program. The purpose of monitoring is to supply recent, accurate information with which you can make appropriate decisions for managing pests in your school. By appropriate we mean informed, intelligent, pest management decisions that “fit” your particular situation. What is appropriate for you will depend on the injury levels you choose to adopt (see Chapter 3), the management techniques you wish to use, and the results you hope to achieve.

Because IPM was developed for agriculture, the original concept of monitoring was applied to agricultural crops and their pests. Over the years, this concept has been adapted for gathering information on pests of urban plants and human structures. In the loosest sense, we also speak of “monitoring” pests of the human body, such as lice; however, in this context monitoring is reduced to simply looking for the pest before initiating treatment. In most situations encountered in schools, monitoring the plants and the structures will be a bit more complex.

This chapter provides a general overview of how to set up and operate a monitoring program. More detailed discussions on monitoring techniques for individual pests are provided in Chapters 5 through 19.

### NOT ENOUGH TIME OR MONEY?

Obviously, time and especially money will constrain what you will realistically be able to do. The most important thing is to go out and look at the problems, and write down what you see. To insure that this job will get done, you may need to figure out how monitoring can be included along with routine maintenance activities. Make sure that personnel who are asked to monitor understand what to look for and how to record the information. Have them carry easy-to-use monitoring forms whenever they go out. An example of a monitoring form for the placement of cockroach traps in a school kitchen is provided in Appendix E. Data from this form is transferred to a simple computerized spreadsheet after each monitoring session in order to facilitate treatment decisions. If the school is contracting out its pest control services, give the pest control company a copy of this form to use or have them develop their own forms subject to the approval of the school.

### LEVELS OF EFFORT USED IN MONITORING

Monitoring need not be time consuming. The idea is to match the level of monitoring effort to the importance of the problem. Monitoring can vary from the extremely casual to the statistically strict, depending on the seriousness of the problem. The levels of effort, listed from casual to strict, are

1. Hearsay or reports from other people’s casual looking (not particularly helpful)
2. Casual looking with no record keeping (not particularly helpful)
3. Casual looking with written observations (useful for schools)
4. Careful inspection with written observations (useful for schools)
5. Regular written observations and quantitative descriptions (useful for schools)
6. Quantitative sampling on a regular basis (appropriate for research projects)
7. Statistically valid quantitative samples (appropriate for research projects)

### WHAT IS MONITORING?

Monitoring is the regular and ongoing inspection of areas where pest problems do or might occur. Information gathered from these inspections is always written down.

### WHY MONITOR?

A monitoring program helps you become familiar with the workings of the target system. This knowledge allows you to *anticipate* conditions that can trigger pest problems, and thus *prevent* them from occurring or catch them before they become serious. Monitoring enables you to make intelligent decisions about treatments.

### Monitoring helps determine if treatment is needed.

- Is the pest population getting larger or smaller? And if you are monitoring plants, is the natural enemy population getting larger or smaller? These



questions affect whether or not you need to treat, and you can get the answers only by inspecting the problem sites on several different occasions.

- How many pests or how much pest damage can be tolerated? This is also referred to as setting injury and action levels, which is discussed in detail in Chapter 3.
- Even when tolerance for pest presence is at or near zero, as in the case of rats, monitoring will result in early pest detection, reducing the likelihood of unexpected pest outbreaks.

**Monitoring helps determine where, when, and what kind of treatments are needed.**

- This includes preventive treatments such as pest-proofing and sanitation. Monitoring will tell you where these are most needed.
- It is unnecessary (and expensive) to treat all parts of a building or all plants on the school grounds for a pest when all areas may not be equally infested. Monitoring will pinpoint infestations and problem areas.

- On plants, monitoring will help you time treatments to target the most vulnerable stage of the pest. The vulnerable stage may change depending on the type of treatment used.

**Monitoring allows you to evaluate and fine-tune treatments.**

Monitoring after a treatment will show you the success or failure of that treatment.

- Did the treatment reduce the number of pests below the level that causes intolerable damage?
- How long did the effect last?
- Did you have to repeat the treatments?
- Were there undesirable side effects?
- Do you need to make adjustments to your treatment plan?

**WHAT TO MONITOR**

**Monitoring plants and their pests includes the regular observation and recording of**

- the condition of the plants (their vigor and appearance)

**Table 2-1. Plant Condition Rating\***

PLANT CONDITION RATING	INDICATORS OF PLANT CONDITION			
	Leaf Color	Amount/Size of Growth	Damaged Plant Parts	Presence of Pest Problems
	Good	Adequate	None to few	No major ones
GOOD	Good	Slightly reduced	Few to common	A few minor ones
FAIR	Poor	Much reduced	Common to abundant	Either major <u>or</u> minor ones occurring frequently
POOR	Poor	Severely reduced	Innumerable	Both major <u>and</u> minor ones occurring frequently

**Leaf Color:** Note that there are healthy plants that do not have bright green leaves. Leaves can be purple, yellow, or sometimes a mottled yellow and green (variegated). "Good" leaf color will not always be the same; it will depend on the kind of plant.

**Amount/Size of Growth:** This refers to the length of the new growth for the season as well as the number of new leaves, and the size of the leaves, flowers, or fruit.

**Damaged Plant Parts:** Look at the whole plant. Are there leaves with holes, spots, or discolorations? Are there wilted or dead leaves? Are there dead twigs or branches? Is the damage only on old leaves while new leaves look perfectly healthy?

**Presence of Pest Problems:** A major pest problem is one that has seriously affected or injured the plant and requires management. A minor pest problem may or may not have affected or injured the plant and may or may not require management.

\*Adapted from Michigan State University 1980

**Table 2-2. Pest and Plant Damage Abundance Rating\***

Abundance Rating	Indicators of Abundance
Few	Organisms or plant damage occasionally found, but only after much searching
Common	Organisms or plant damage easily found during typical searching
Abundant	Organisms or plant damage found in large numbers—obvious without searching
Innumerable	Organisms or plant damage extremely numerous—obvious without searching

\*Adapted from Michigan State University 1980

- the kind and abundance of pests (insects, mites, moles, weeds, etc.) as well as natural enemies (ladybugs, spiders, lacewing larvae, syrphid fly larvae, etc.)
- the amount of plant damage
- weather conditions (record any unusually dry, hot, wet, or cold weather in the last few weeks)
- human behaviors that affect the plants or pests (foot traffic that compacts the soil, physical damage to plants caused by people, insistence on having certain plants grow in inappropriate situations, etc.)
- your management activities (pruning, fertilizing, mulching, treating pests, etc.) and their effects on the plants and the pest population

Tables 2-1 and 2-2 provide more information to help you quantify the first three points, above. Using the four abundance ratings in Table 2-2 will make monitoring faster and easier and will help to standardize observations. If you get to a point where you need more precision in your data, you can count the number of pests or their signs in a given area or on a certain number of leaves.

### Monitoring structures involves the regular observation and recording of

- the conditions of the building inside and out (structural deterioration, holes that allow pests to enter, conditions that provide pest harborage)
- the level of sanitation inside and out (waste disposal procedures, level of cleanliness inside and out, conditions that supply food to pests)
- the amount of pest damage and the number and location of pest signs (rodent droppings, termite shelter tubes, cockroaches caught in traps, etc.)

- human behaviors that affect the pests (working conditions that make it impossible to close doors or screens, food preparation procedures that provide food for pests, etc.)
- your management activities (caulking, cleaning, setting out traps, treating pests, etc.) and their effects on the pest population

Table 2-3 provides

specific information on monitoring tools for both plants and structures.

## IDENTIFYING THE TARGET PEST

It is *extremely* important to correctly identify the pest that is causing problems. You cannot manage a pest effectively without knowing what it is. For instance, putting out mouse traps to control what is really a rat problem can only result in failure. Chapters 5 through 19 provide information that will help you identify some of the most common pests found in and around schools. If you are uncertain of the identity of your pest, take a specimen to a professional for identification. Appendix F describes how to properly collect and preserve an insect or plant specimen when seeking an identification.

Once the pest is identified, read about its life cycle, food sources, habitat preferences, and natural enemies. Chapters 5 through 19 will provide this information for the common pests, but if your pest is not included here, check the Recommended Reading section at the end of this manual for books that can help you. Knowing the life habits of your pest will give you clues about what to look for when monitoring and help you decide how to best manage the pest.

If only damage symptoms and not the pest itself are visible, a sleuthing job is in order. More observation or observation at a different time of day may be necessary. You can also talk to other pest management professionals, local gardeners, nursery personnel, Cooperative Extension staff, or university researchers.

## TIMING MONITORING ACTIVITIES

Timing and frequency of monitoring differs depending on the site and the pest(s). Outdoors, monitoring

**Table 2-3. Tools Used in Monitoring**

TOOLS	PLANTS	STRUCTURES
Monitoring forms—use these to write down what you see	X	X
Maps or site plans of the buildings or grounds—use these to mark where you find pests and where you put traps	X	X
Clipboard—use this to hold your monitoring forms and maps	X	X
Flashlight with a halogen bulb—use this to detect nighttime pest activity. A blacklight bulb can be substituted to detect scorpions.	X	X (for viewing areas under counters, in closets, etc. during the day)
Sticky traps—use these to monitor a variety of insects, mites, and small rodents.	X (for many insects the color of the trap is important, e.g., thrips are attracted to blue; whiteflies prefer yellow)	X (glue boards for monitoring rodents)
Hand lens—This is a small magnifying glass. Use this to help you see mites and small insects. A lens that magnifies things at least 10 times (=10x) is usually adequate. A 15x lens can be used to distinguish among various mite species and other similarly small pest organisms such as thrips.	X	X
Plastic bags or small vials—use these to hold specimens for later examination or identification.	X	X
Small knife or screwdriver	X (use to dig up weeds for specimens or for control)	X (use to probe damaged wood, extract insect droppings from wood, etc.)
Ladder	X	X
Camera—use this for documenting pest damage to plants or structures before and after IPM methods have been applied	X	X

usually begins when plants put out new leaves in spring, and ends when leaves fall in autumn. Plants with annually recurring pest problems receive more attention than relatively pest-free plants. Monitoring can be incorporated into routine grounds maintenance activities such as weekly mowing, or can be a separate activity that occurs bi-weekly, monthly, or less frequently, depending on plant, pest, site, weather, etc.

Indoors, monitoring might occur weekly during the early stages of solving a serious pest infestation,

then taper off to monthly, once the pest problem is under control.

Some pests are more active at night than during the day. Thus, some monitoring may need to occur after dark. However, this is usually only necessary when you are trying to identify a nocturnal pest or trying to determine its travel routes, feeding habits, etc. Once this is known, nighttime monitoring can often be replaced by daytime inspection of traps, plant foliage, etc. for signs of pest presence.

## RECORD KEEPING

A monitoring program is only as useful as its record keeping system. Records function as the memory of the IPM program. Human memory is unreliable and can lead to erroneous conclusions when comparing effects of treatment or other variables on the pest problem.

### **Record keeping is important to you because**

- you can learn about your specific pests and their management faster if you write down your observations
- you can learn more about your specific pest problems because you won't forget what you observed, which treatments you tried, and when you tried them

### **Record keeping is important to the school system and the IPM program because**

- monitoring records form the basis for making decisions on the most sensible distribution of available resources to the areas most in need of attention or observation
- information can be easily and accurately passed from one employee to another
- information is not lost when employees leave or retire

### **What Should The Record Show?**

The record should always show

- what you are monitoring—name of the pest (common name *and* scientific name, if possible),

stage of the pest (immature, adult), and for landscape pests, the name of the plant

- where you are monitoring—a map is always useful
- when you are monitoring—date and time
- who is doing the monitoring

The rest of the information you will need to record is listed under "What to Monitor," above. As mentioned before, the information in Tables 2-1 and 2-2 will help you to standardize some of your observations. Table 2-1 is specifically for plants, but Table 2-2 can be used for structural pests as well as plant pests.

It is also important to standardize the format and the process by which the records are kept in order to maintain continuity from season to season and person to person. See Appendix E for sample forms. You may want to design forms with boxes to be checked off so less writing will be necessary.

Pest patterns emerge quickly when data gathered during monitoring is made visual, facilitating decision-making. This can be done by hand on graph paper, or by using one of the many graph-making computer programs included in spreadsheet software. Figure 2-1 shows fluctuations in cockroach trap counts.

### **No Time?**

Try to make record keeping as easy and practical as possible. A person who is on the site frequently should be the person who monitors and keeps records. Try other solutions such as

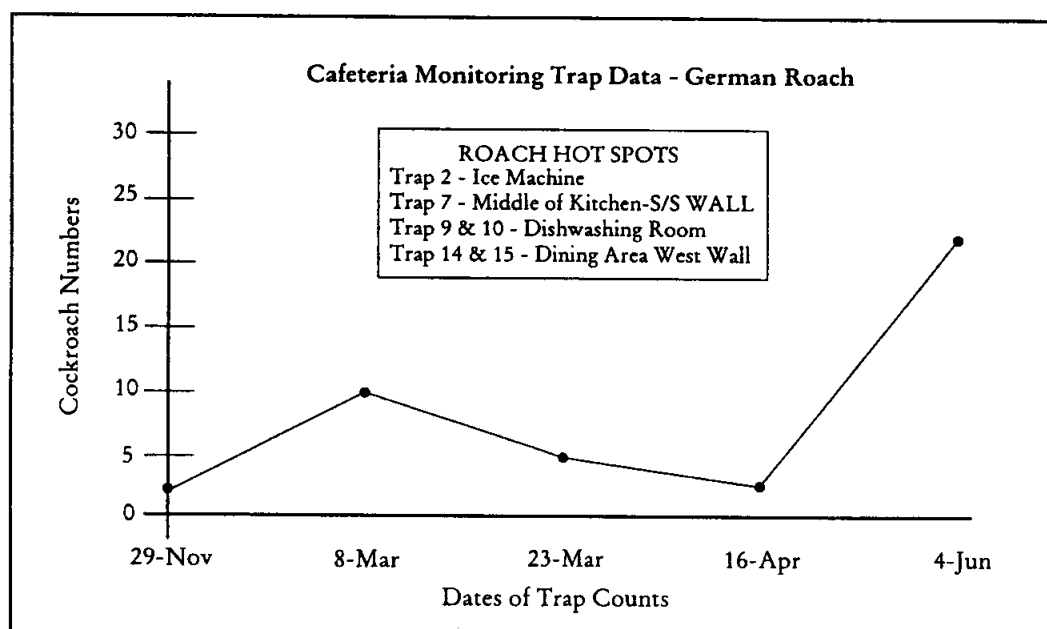

Figure 2-1. A graph of Fluctuating Cockroach Trap Counts

- asking an interested parent to help record monitoring information, either by following the pest manager or by interviewing the person later
- setting up a small student project to follow pest managers around and record what they do
- having a quarterly or monthly meeting to discuss monitoring and using a cassette recorder to record the information

### Evaluating Your Actions

Without evaluating the actions you took to reduce the pest problem, you will not be able to improve your management program from year to year. Ask yourself the following questions:

- Was the pest problem a significant one?
- Were the actions I took necessary or would the problem have gotten better if I had left it alone?
- Did the actions I took and the treatments I used adequately solve the problem?

- Could I manage the problem better next time? If so, how?
- Do I need more or better information to make treatment decisions in the future?

### BIBLIOGRAPHY

- Daar, S. 1997. Structural IPM successes at NASA's Ames research center. *IPM Practitioner* 19(2):1-11.
- Davidson, J.A., C.F. Cornell, and D.C. Alban. 1986. The untapped alternative. *American Nurseryman* 167(11):99-109.
- Davidson, J.A. et al. 1988. Making the pilot fly. *American Nurseryman* 169(10):51-60.
- Michigan State University. 1980. *Pest Management Manual*. Departments of Resource Development, Entomology, & Forestry, East Lansing, MI.
- Owens, J.M. and G.W. Bennett. 1983. Comparative study of German cockroach (Dictyoptera: Blattellidae) population sampling techniques. *Environmental Entomology* 12:1040-1046.
- Rust, M.K., J.M. Owens, and D.A. Reiersen. 1995. *Understanding and Controlling the German Cockroach*. Oxford Univ. Press, New York. 430 pp.

---

# CHAPTER 3

## SETTING INJURY AND ACTION LEVELS

Total eradication of pest organisms is virtually impossible to achieve. A more realistic goal is to determine the “injury level”—the number of pests or the amount of pest-related damage that can be tolerated without suffering an unacceptable medical, economic, or aesthetic loss. The “action level”—the number of pests necessary for treatment to occur to prevent the injury level being reached—depends largely on pest biology and environmental conditions supporting the pest.

### DETERMINE INJURY LEVELS FIRST

Before you can determine the action level, you must first determine the injury level. This is the level of damage or the level of the pest population that causes unacceptable injury. The injury level will be higher than the action level (see Figure 3-1).

### Three Types of Injury

There are three types of injury in IPM:

- Aesthetic injury is applied mainly to plants. This is injury that affects the appearance without affecting the health of the plant. There are few indoor pests or pests of structures that cause only aesthetic damage.
- Economic injury refers to pest damage that causes monetary loss, e.g., clothes moths destroying band uniforms or a plant disease that causes the death of a tree.
- Medical injury relates to human health problems caused by pests like rodents, flies, yellow-jackets, poison ivy, etc.

### Injury Levels Differ Depending on the Pest

The number of pests or amount of pest damage you can tolerate (another way to think of injury level) will depend on the kind of pest and its location. Columns of ants marching through

an unused outbuilding is an entirely different situation from an ant invasion in the cafeteria. Many thousands of aphids can usually be tolerated on a tree, but one louse or nit on a child’s head cannot.

### Don’t Set the Level too Low

One of the major causes of unnecessary treatments for pests is unrealistically low tolerance levels. Obviously, there is little leeway in tolerance for pests that have consequences for human health or the school budget, but for many other pests, the range of tolerance can be very wide. By understanding which kinds of damage are serious and which are unimportant and by simply changing the way we view pests and pest damage, we can avoid many unnecessary treatments. For instance, most trees and shrubs can support substantial populations of caterpillars, aphids, psyllids, or leafhoppers without coming to any harm. Lawns can still be very attractive and functional even though the grass is not all of one kind and there are a number of weeds mixed in (as long as they don’t pose a tripping hazard, of course).

### Determining the Injury Level

We all have intuitive, unspecified notions of injury level

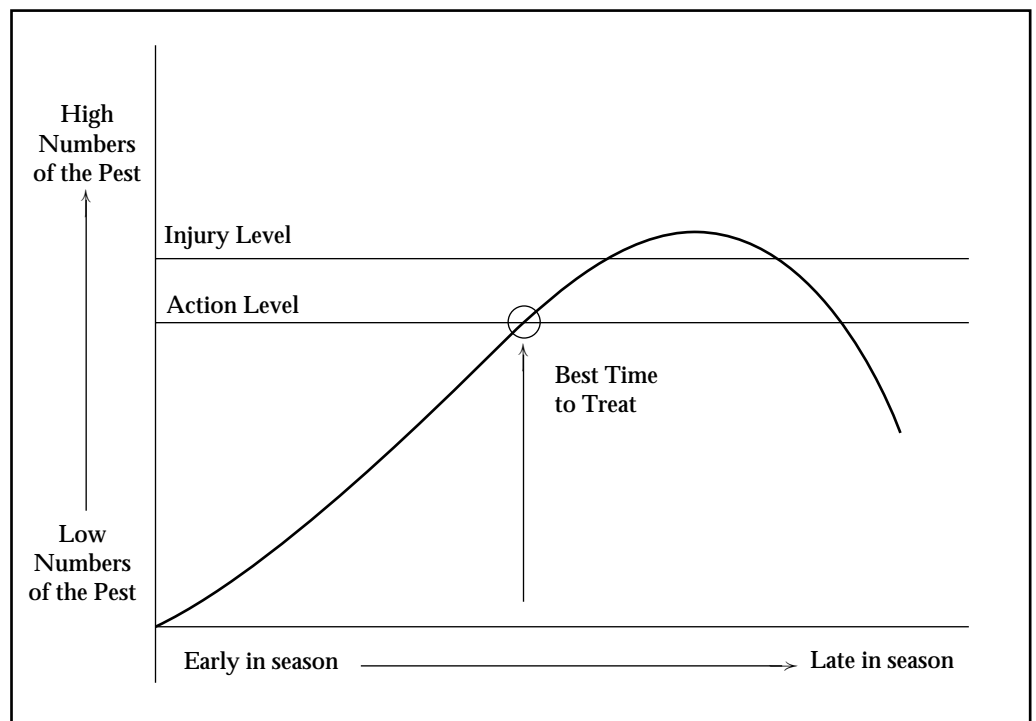

Figure 3-1. Graph Illustrating Injury and Action Levels

---

in various pest management situations, but these may not be accurate. In an IPM program, the aim is to try to make injury levels explicit and accurate. Monitoring is the only way to do this. It also takes knowledge and experience to understand the life cycles of pests, how fast their populations grow, and whether or not their damage will have serious consequences.

Example: Last year a chemical control was used when the aphid infestation in trees was first noticed by a school employee. This year, a monitoring program was initiated. Data collected indicated that 100 to 200 aphids per leaf produced no significant damage to the tree. In fact, the data showed that only when there were over 500 aphids per leaf did leaves start to drop from the tree. This level of aphids also began to elicit complaints about the sticky honeydew raining down from the tree.

Periodically, the injury level should be re-evaluated for each pest and for each site. Changes in weather conditions, plant cultivars grown, horticultural practices, level of IPM experience of employees, building renovations, etc., can affect the setting of injury levels.

## **DETERMINE ACTION LEVELS BASED ON INJURY LEVELS**

The action level is the level of pest damage or number of pests that triggers a treatment to prevent pest numbers from reaching the injury level. The action level will be lower than the injury level (see Figure 3-1). Determining action levels involves making educated guesses about the likely impacts of numbers of pests present in a given place at a given time. In other words, you need to estimate how high you can let the pest population grow before you need to treat to prevent unacceptable injury. The action level must be determined and treatments applied before the injury level is reached.

Example: You know from previous observations that the injury level for the shade tree you are monitoring is 15 caterpillars per foot of branch. Current counts show 5 caterpillars per foot. These counts, weather data, and your experience lead you to expect the pest population will exceed the injury level in about two weeks, unless there is a surge in natural enemy activity or the temperature drops. Your choices depend on available time and resources:

- (1) You can decide to set your action level at 5 to 7 caterpillars and schedule a treatment right away if it will be difficult to check again in a week.
- (2) Because the trees are extremely valuable and because

you see that caterpillars are starting to die from attacks by natural enemies, schedule another visit in one week. At that time, if natural mortality does not appear likely to keep pest numbers below the injury level, there is still time to apply an insecticide. In this case, set your action level at 7 to 10 caterpillars.

When an IPM program is first implemented for a particular pest/site, guidance on setting the action level may be available from existing school records, from the literature on the pest, through discussions with those who have experience managing the pest elsewhere, or from recollections of the problem in prior years by school staff.

### **Set Conservative Action Levels in the Beginning**

During the beginning phase of an IPM program, it is wise to be conservative when establishing an initial action level. Set it low enough (i.e., low numbers of pests trigger treatments) to insure a wide margin of safety while learning monitoring methods. The initial action level should then be compared with other action levels for the same pest at different sites or locations. This is necessary to determine if the action level is set too high or too low, if treatments were necessary or not, and if they were properly timed.

The easiest way to collect comparative data is to set aside a portion of a school that remains untreated at the time another area is treated, or to monitor two schools where different action levels are applied to the same pest. By monitoring both sites, and comparing records, adjustment of the initial action level up or down can be evaluated.

### **Avoid “Revenge” Treatments**

Sometimes action takes place after the injury level has been reached and the pest population has begun to decline naturally (Figure 3-2). These “revenge” treatments are generally useless at controlling pests, damaging to the environment, and an unnecessary expenditure of time and resources.

## **IPM PROGRAM EVALUATION**

One of the most important components of an IPM program is evaluating whether or not it’s working, and fine-tuning it when necessary. Evaluation is rarely done in conventional pest control. Many people have become habituated to spraying on a regular basis, often without questioning the long-term efficacy or side-effects of what they are doing. An IPM-oriented program would view the need to regularly apply a toxic material as an indication that the program wasn’t working efficiently, and seek

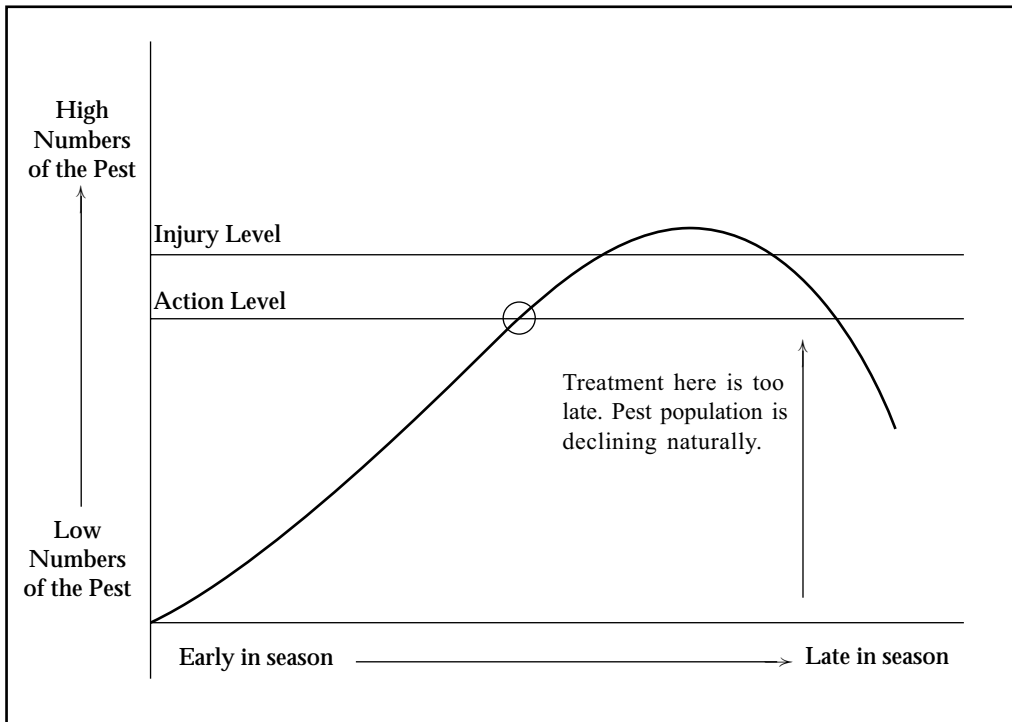

**Figure 3-2. Graph Illustrating “Revenge” Treatments**

other solutions in order to reduce pesticide use and maximize effects of non toxic or natural controls.

For purposes of overall evaluation, it is helpful to view the IPM program as composed of many simultaneously occurring, interacting systems or processes:

- monitoring
- record-keeping
- decision making regarding treatment activities
- delivery of treatments
- evaluation of treatments
- collection and cataloging of reference materials on management of the pests
- education and training of school personnel in IPM
- communication to school personnel regarding IPM program plans and progress
- budgetary planning
- evaluation of overall IPM program

Each of these components should have, as part of the development of the initial program plan, some expressed objectives or criteria by which the component is judged successful or not. But, in addition, it is important to determine the following:

- Were all the necessary components to the program actually

developed?

- Were they integrated successfully?
- Were the right people involved in the integration of the components into a whole program?

### Questions to Ask After Treatment Action

At the end of the year, use monitoring data to answer the questions below and make any necessary adjustments in methods for the next season. After two or three seasons of fine-tuning, including modifying the habitat, redesigning parts of the school facility, or changing behavioral practices to discourage pests, you can

generally expect problems to have lessened considerably, and in some cases disappear. After reaching this point, periodic monitoring rather than active management may be all that is needed.

- Was the pest population adequately suppressed (below injury level)?
- Was the pest population suppressed in a timely manner?
- Was the planned procedure used? If not, what was different?
- What damage was produced? What damage was tolerable?
- In the landscape, were natural enemies affected by treatments? How?
- If natural enemies were killed by treatments, will this cause problems elsewhere or at a later period?
- Were there any other side effects from the treatments? Any unanticipated consequences (good or bad)?
- If ineffective, should the treatments be repeated, should another kind of treatment be evaluated?
- Is the plant or structure worth maintaining? Can the site be changed to eliminate or reduce the problem for the same costs of treatment?
- What were the total costs of the treatment—costs of suppression vs. cost of damage, costs of side-effects or



---

unexpected consequences, costs of risks from pesticides or benefits from reduction of pesticide, etc.

## **ASSESSING COST EFFECTIVENESS**

Cost effectiveness is central to a decision to continue an IPM program. Data from IPM programs in school systems and park districts across the country indicate that IPM costs no more than conventional spray programs, and often costs considerably less.

The Ann Arbor School District in Michigan has found that hiring a contractor to monitor 35 schools on a regular basis, and treat only if action levels were reached, resulted in only a single treatment (a crack and crevice application of low-toxic boric acid for cockroaches) during the course of a full year. In the first IPM year, this program cost the same as the previous conventional program. Costs were expected to drop the second year when in-house staff were scheduled to assume monitoring responsibilities (Cooper 1990).

Whether an IPM program raises or lowers costs depends in part on the nature of the current house-keeping, maintenance, and pest management operations. The costs of implementing an IPM program can also depend on whether the pest management services are contracted out, performed in-house, or both.

Prior to 1985, Maryland's Montgomery County Public Schools (MCPS) had a conventional pesticide-based program. Over 5,000 applications of pesticides were made to school district facilities that year. Public concerns about potential hazards to students and school personnel led to development of an IPM program that emphasized sanitation, habitat modification, and less-toxic baits and dusts in place of conventional sprays. By 1988, annual pesticide applications had dropped to 600, and long-term control of pests had improved.

According to William Forbes, pest management

supervisor for the school district, under conventional pest control in 1985, the district spent \$513 per building per year. This covered two salaries, two vehicles, and materials for two employees who serviced 150 sites. Only crawling insects and rodents were managed by in-house staff. An additional \$2400 per building per year was paid for contracted services at 11 sites. By 1988, under an IPM program, those same 11 sites were being managed by in-house staff at a cost of only \$500 per site per year. In addition, a total of 200 school buildings (33% increase) were serviced for a cost of \$575 per building per year, which covered three salaries, three vehicles and supplies. No outside contracting was needed and the program covered virtually every structural pest, from pigeons to termites (Forbes 1990).

During the start-up phase, there are usually costs associated with conversion to IPM. These might include staff training, building repair and maintenance, new waste storage containers, screening, traps, a turf aerator, etc. However, these expenses are usually recouped within the first year or two of the program, and benefits continue to accrue for years.

Whether such costs are budgeted as a pest control expense or distributed to the building maintenance budget or the landscaping account depends on the budgetary format of the school system. In the long-term, training, repair and maintenance activities, and equipment purchases will reduce overall costs of the pest control operations, as well as other maintenance and operating budgets.

## **BIBLIOGRAPHY**

- Cooper, S. 1990. The ABCs of non-toxic pest control. *School Business Affairs* (July 1990):14-17.
- Forbes, W. 1990. From spray tanks to caulk guns: successful school IPM in Montgomery County, Maryland. *Journal of Pesticide Reform* 10(4):9-11.

---

# CHAPTER 4

## SELECTING TREATMENT STRATEGIES

IPM is not simply a matter of substituting “good” pesticides for “bad” pesticides. Too often we want an easy solution, a “magic bullet” that will solve all our problems in one shot. Unfortunately, pest management is complicated, and we cannot always expect a simple solution to pest problems. IPM is based on the fact that combined strategies for pest management are more effective in the long run than a single strategy. A good pest manager considers as many options as possible and tries to combine them into an effective program. The best pest managers have ideas for new and creative ways to solve pest problems. Wherever possible, IPM takes a preventive approach by identifying and removing, to the degree feasible, the basic causes of the problem rather than merely attacking the symptoms (the pests). This prevention-oriented approach is also best achieved by integrating a number of treatment strategies.

### CRITERIA FOR SELECTING TREATMENT STRATEGIES

Once the IPM decision-making process is in place and monitoring indicates a pest treatment is needed, the choice of specific strategies can be made. Choose strategies that are

- least hazardous to human health
- least disruptive of natural controls in landscape situations
- least toxic to non-target organisms other than natural controls
- most likely to be permanent and prevent recurrence of the pest problem
- easiest to carry out safely and effectively
- most cost-effective in the short- and long-term
- appropriate to the site and maintenance system

#### Least hazardous to human health

It is particularly important around children to take the health hazards of various strategies into consideration.

Example: Aerosol sprays can kill cockroaches; however, they can also pose potential hazards to humans because the pesticide volatilizes in the air, increasing the likelihood of respiratory or lung exposure of students and staff. In addition, aerosol sprays may leave

residues on surfaces handled by students and teachers. When cockroach baits are used instead, the pesticide is confined to a much smaller area, and if applied correctly, the bait will be out of reach of students and staff. Baits volatilize very little so lung exposure is not a problem.

#### Least disruptive of natural controls

In landscape settings, you want to try to avoid killing off the natural enemies that aid in controlling pest organisms. Unfortunately and for a number of reasons, natural enemies are often more easily killed by pesticides than are the pests. When choosing treatment strategies, always consider how the strategy might affect natural enemies. When choosing a pesticide, try to use one that has less effect on natural enemies. For help in determining this, see the resources listed in Appendix G.

#### Least toxic to non-target organisms

The more selective the control, the less harm there will be to non-target organisms.

Example: Aphid populations in trees often grow to high numbers because ants harvest the honeydew (sweet exudate) produced by the aphids, and protect them from their natural enemies. The ants that protect these aphid pests are often beneficial in other circumstances, aerating the soil and helping to decompose plant and animal debris. By excluding the ants from the tree with sticky bands around the trunk, it is often possible to achieve adequate suppression of the aphids without harming the ant populations.

#### Most likely to be permanent and prevent recurrence of the problem

Finding treatments that meet this criteria is at the heart of a successful IPM program because these controls work without extra human effort, costs, or continual inputs of other resources. These treatments often include changing the design of the landscape, the structure, or the system to avoid pest problems. The following are examples of preventive treatments:

- educating students and staff about how their actions affect pest management
- caulking cracks and crevices to reduce cockroach (and other insect) harborage and entry points

- instituting sanitation measures to reduce the amount of food available to ants, cockroaches, flies, rats, mice, etc.
- cleaning gutters and directing their flow away from the building to prevent moisture damage
- installing a sand barrier around the inside edge of a foundation to prevent termites from crawling up into the structure
- using an insect growth regulator to prevent fleas from developing in an area with chronic problems

### **Easiest to carry out safely and effectively**

While the application of pesticides may seem comparatively simple, in practice it may not be the easiest tactic to carry out safely or effectively. Use of conventional pesticides often involves wearing protective clothing, mask, goggles, etc. In hot weather, people are often reluctant to wear protective gear because of the discomfort this extra clothing causes. By choosing not to wear the protective clothing, applicators not only violate the law, but also risk exposure to toxic materials.

### **Most cost-effective in the short- and long-term**

In the short-term, use of a pesticide often appears less expensive than a multi-tactic IPM approach; however, closer examination of the true costs of pesticide applications over the long-term may alter this perception. In addition to labor and materials, these costs include mandatory licensing, maintaining approved pesticide storage facilities, disposing of unused pesticides, liability insurance, and environmental hazards.

Other factors to consider are whether a particular tactic carries a one time cost, a yearly recurring cost or a cost likely to recur a number of times during the season. When adopting any new technology (whether it be computers or IPM), there will be some start-up costs. Once the program is in place, IPM generally costs less than or about the same as conventional chemically-based programs (see the discussion on “Assessing Cost Effectiveness” in Chapter 3).

In addition, parental and community concern about the use of conventional pesticides may make any use of pesticide in and around schools problematic. A public relations headache can develop over comparatively innocuous incidents, and require substantial amounts of time from the highest paid employees of the school district to attend meetings, prepare policy statements, etc. These costs should also be factored into the pest control equation.

### **Appropriate to the weather, soils, water, and the energy resources of the site and the maintenance system**

Skillfully designed landscapes can reduce pest problems as well as use of water and other resources. We cannot stress enough the importance of choosing the right plant for the right spot. Plants that are forced to grow in unsuitable sites where they are unable to thrive will be a continual source of problems. When plants die on the school site, take the time to find a replacement that is suited to the landscape.

## **TIMING TREATMENTS**

Treatments must be timed to coincide with a susceptible stage of the pest and, if at all possible, a resistant stage of any natural enemies that are present. Sometimes the social system (i.e., the people involved or affected) will impinge on the timing of treatments. Only monitoring can provide the critical information needed for timing treatments and thereby make them more effective.

Example: To control scales on plants using a low-toxic material such as insecticidal soap or horticultural oil, it is necessary to time treatments for the period (often brief) when immature scales (crawlers) are moving out from under the mother scales, seeking new places to settle down. It is at this stage that scales are susceptible to soaps and oils.

### **Spot Treatments**

Treatments, whether pesticides or non-toxic materials, should only be applied when and where needed. It is rarely necessary to treat an entire building or landscape area to solve a pest problem. By using monitoring to pinpoint where pest numbers are beginning to reach the action level and confining treatments to those areas, costs and exposure to toxic materials can be kept to a minimum.

## **SUMMARY OF AVAILABLE TREATMENT OPTIONS**

The following is a list of general categories of treatment strategies. We have included some examples to help illustrate each strategy. The list is not intended to be exhaustive since products change, new ones are discovered or invented, and ingenious pest managers develop new solutions to old problems every day.

### **Education**

Education is a cost-effective pest management strategy.

---

Information that will help change people's behaviors—particularly how they dispose of wastes and store food—plays an invaluable part in managing pests like cockroaches, ants, flies, yellowjackets, and rodents. Education can also increase people's willingness to share their environment with other organisms so that people are less likely to insist on toxic treatments for innocuous organisms. Teaching children about IPM will have a long-term effect on the direction of pest management in this country as these students grow up to become consumers, educators, policy makers, and researchers.

### **Habitat Modification**

Pests need food, water, and shelter to survive. If the pest manager can eliminate or reduce even one of these requirements, the environment will support fewer pests.

### **Design or Redesign of the Structure**

Design changes can incorporate pest-resistant structural materials, fixtures, furnishings, etc. Sometimes these changes can entirely eliminate pest habitat. For example, buildings designed without exterior horizontal ledges will reduce pigeon problems. Inside, industrial, stainless steel wire shelving mounted on rolling casters helps reduce roach habitat and facilitates cleanup of spilled food.

### **Sanitation**

Sanitation can reduce or eliminate food for pests such as rodents, ants, cockroaches, flies, and yellowjackets.

### **Eliminating Sources of Water for Pests**

This involves fixing leaks, keeping surfaces dry overnight, and eliminating standing water.

### **Eliminating Pest Habitat**

How this can be done will vary depending on the pest, but some examples are caulking cracks and crevices to eliminate cockroach and flea harborage, removing clutter that provides roach habitat, and removing dense vegetation near buildings to eliminate rodent harborage.

### **Modification of Horticultural Activities**

Planting techniques, irrigation, fertilization, pruning, and mowing can all affect how well plants grow. A great many of the problems encountered in school landscapes are attributable to using the wrong plants and/or failing to give them proper care. Healthy plants are often likely to have fewer insect, mite, and disease problems. It is very important that the person responsible for the school landscaping have a good foundation of knowledge about the care required by the particular plants at the school or

be willing to learn.

### **Design or Redesign of Landscape Plantings**

- choosing the right plant for the right spot and choosing plants that are resistant to or suffer little damage from local pests. This will take some research. Ask advice of landscape maintenance personnel, local nurseries, local pest management professionals, and County Extension agents or the master gardeners on their staffs
- including in the landscape flowering plants that attract and feed beneficial insects with their nectar and pollen, e.g., sweet alyssum (*Lobularia* spp.) and flowering buckwheat (*Eriogonum* spp.), species from the parsley family (*Apiaceae*) such as yarrow and fennel, and the sunflower family (*Asteraceae*) such as sunflowers, asters, daisies, marigolds, zinnias, etc.
- diversifying landscape plantings—when large areas are planted with a single species of plant, a pest can devastate the entire area

### **Physical Controls**

#### **Vacuuming**

A heavy duty vacuum with a special filter fine enough to screen out insect effluvia (one that filters out particles down to 0.3 microns) is a worthwhile investment for a school. Some vacuums have special attachments for pest control. The vacuum can be used not only for cleaning, but also for directly controlling pests. A vacuum can pull cockroaches out of their hiding places; it can capture adult fleas, their eggs, and pupae; and a vacuum can be used to collect spiders, boxelder bugs, and cluster flies.

#### **Trapping**

Traps play an important role in non-toxic pest control; however, in and around schools, traps may be disturbed or destroyed by students who discover them. To prevent this, place them in areas out of reach of the students in closets, locked cupboards, etc. Another strategy is to involve students in the trapping procedures as an educational activity so they have a stake in guarding against trap misuse or vandalism.

Today a wide variety of traps is available to the pest manager. Some traps are used mainly for monitoring pest presence. These include cockroach traps and various pheromone (insect hormone) traps, although if the infestation is small, these traps can sometimes be used to control the pest. Other traps include the familiar snap traps for mice and rats, electric light traps for flies, and flypaper. There are also sticky traps for whiteflies and thrips, cone

---

traps for yellowjackets, and box traps for skunks, raccoons, and opossums.

### **Barriers**

Barriers can be used to exclude pests from buildings or other areas. Barriers can be as simple as a window screen to keep out flying and crawling insects or sticky barriers to exclude ants from trees. More complicated barriers include electric fences to keep out deer and other vertebrate wildlife and L-shaped footings in foundations to exclude rodents.

### **Heat, Cold, Electric Current**

Commercial heat treatments can be used to kill wood-destroying pests such as termites. A propane weed torch can be used to kill weeds coming up through cracks in pavement. Freezing can kill trapped insects such as yellowjackets before emptying traps, kill clothes moths, and kill the eggs and larvae of beetles and moths that destroy grain. The “Electrogun®”, which passes an electric current through wood, can be used for killing termites.

### **Removing Pests by Hand**

In some situations removing pests by hand may be the safest and most economical strategy. Tent caterpillars can be clipped out of trees, and scorpions can be picked up with kitchen tongs and killed in soapy water or in alcohol.

### **Biological Controls**

Biological control uses a pest’s natural enemies to attack and control the pest. We use the word “control” rather than “eliminate” because biological control usually implies that a few pests must remain to feed the natural enemies. The exception to this is a separate category of biological control called microbial control which includes the use of plant and insect pathogens. Microbial controls are generally used like pesticides to kill as many pests as possible. Biological control strategies include conservation, augmentation, and importation.

#### **Conservation**

Conserving biological controls means protecting those already present in the school landscape. To conserve natural enemies you should do the following:

- Treat only if injury levels will be exceeded.
- Spot treat to reduce impact on non-target organisms.
- Time treatments to be least disruptive in the life

cycles of the natural enemies.

- Select the most species-specific, least-damaging pesticide materials, such as *Bacillus thuringiensis*, insect growth regulators that are specific to the pest insect, and baits formulated to be attractive primarily to the target pest.

#### **Augmentation**

This strategy artificially increases the numbers of biological controls in an area. This can be accomplished by planting flowering plants to provide pollen and nectar for the many beneficial insects that feed on the pest insects or purchasing beneficials from a commercial insectary. Examples of the best known commercially available natural enemies include lady beetles, lacewings, predatory mites, and insect-attacking nematodes. These are but a very small part of the large and growing number of species now commercially available for release against pests. Learning when to purchase and release them and how to maintain them in the field should be emphasized in any landscape pest management program.

#### **Importation**

People often ask if parasites or predators can be imported from another country to take care of a particularly disruptive pest in their area. It is true that the majority of pests we have in North America have come from other parts of the world, leaving behind the natural enemies that would normally keep them in check. “Classical” biological control involves searching for these natural enemies in the pest’s native area and importing these natural enemies into the problem area. This is not a casual adventure: it must be done by highly trained specialists in conjunction with certain quarantine laboratories approved by the USDA. Permits must be obtained and strict protocols observed in these laboratories.

The whole process takes a good deal of money to pay for the research, travel, permits, etc. Unfortunately, there is a dwindling amount of money for biological control research and importation, and what money there is goes to the biggest pests; therefore, unless there is an increase in funding in the near future, few of the pests that plague schools will become the object of biological control importations. Public knowledge about the value of importation projects can help stimulate funding and additional importations. Once the imported natural enemies become established in their new home, they usually provide permanent control of the pest. Patience is needed, however, because establishment can take several

---

years.

### **Microbial controls**

Microbial controls are naturally occurring bacteria, fungi, and viruses that attack insects and weeds. A growing number of these organisms are being sold commercially as microbial pesticides. Because each of these microbial pesticides attacks a narrow range of pests, non-target organisms are much less likely to be affected.

The most well-known microbial insecticide is *Bacillus thuringiensis*, or “BT.” The most widely sold strain of BT kills caterpillars. Another strain kills only the larvae of black flies and mosquitoes, and a third strain kills only certain pest beetles.

Microbial herbicides made from pathogens that attack weeds are commercially available for use in agricultural crops. In the near future, there may be commercial products for use in urban horticultural settings.

### **Least-Toxic Chemical Controls**

The health of school residents and long-term suppression of pests must be the primary objectives that guide pest control in school settings. To accomplish these objectives an IPM program must always look for alternatives first and use pesticides only as a last resort.

Many people are familiar with insecticides such as malathion, fungicides such as benomyl (Benlate®), and herbicides such as 2,4-D. These and similar materials have engendered controversy over possible hazards they pose to human health and the environment. There are many other chemical products to choose from that are relatively benign to the larger environment and at the same time effective against target pests.

“Least-toxic” pesticides are those with all or most of the following characteristics: they are effective against the target pest, have a low acute and chronic toxicity to mammals, biodegrade rapidly, kill a narrow range of target pests, and have little or no impact on non-target organisms. More and more such products are reaching the market. These include materials such as the following:

- pheromones and other attractants
- insect growth regulators (IGRs)
- repellents
- desiccating dusts

- pesticidal soaps and oils
- some botanical pesticides

### **Pheromones**

Animals emit substances called pheromones that act as chemical signals. The sex pheromones released by some female insects advertise their readiness to mate and can attract males from a great distance. Other pheromones act as alarm signals.

A number of pheromone traps and pheromone mating confusants are now commercially available for insect pests. Most of the traps work by using a pheromone to attract the insect into a simple sticky trap. The mating confusants flood the area with a sex pheromone, overwhelming the males with stimuli and making it very difficult for them to pinpoint exactly where the females are.

### **Insect Growth Regulators (IGRs)**

Immature insects produce juvenile hormones that prevent them from metamorphosing into adults. When they have grown and matured sufficiently, their bodies stop making the juvenile hormones so they can turn into adults. Researchers have isolated and synthesized some of these chemicals and when they are sprayed on or around certain insects, these insect growth regulators prevent the pests from maturing into adults. Immature insects cannot mate and reproduce, so eventually the pest population is eliminated. The IGRs methoprene and fenoxycarb are used to suppress fleas, and hydroprene is used against cockroaches.

Since humans and other mammals don’t metamorphose as insects do, our bodies do not recognize juvenile hormones.

### **Repellents**

Some chemicals repel insects or deter them from feeding on treated plants. For example, a botanical insecticide extracted from the neem tree (*Azadirachta indica*) can prevent beetles and caterpillars from feeding on treated rose leaves. Current research shows that neem has a very low toxicity to mammals. A number of neem products are currently available.

### **Desiccating Dusts**

Insecticidal dusts such as diatomaceous earth and silica aerogel, made from natural materials, kill insects by absorbing the outer waxy coating that keeps water inside their bodies. With this coating gone the insects

---

die of dehydration.

Silica aerogel dust can be blown into wall voids and attics to kill drywood termites, ants, roaches, silverfish, and other crawling insects.

### **Pesticidal Soaps and Oils**

Pesticidal soaps are made from refined coconut oil and have a very low toxicity to mammals. (They can be toxic to fish, so they should not be used around fish ponds.) Researchers have found that certain fatty acids in soaps are toxic to insects but decompose rapidly leaving no toxic residue. Soap does little damage to lady beetles and other hard-bodied insects but could be harmful to some soft-bodied beneficials. A soap-based herbicide is available for controlling seedling stage weeds; the soap kills the weeds by penetrating and disrupting plant tissue. Soap combined with sulfur is used to control common leaf diseases such as powdery mildew.

Insecticidal oils (sometimes called dormant oils or horticultural oils) also kill insects and are gentle on the environment. Modern insecticidal oils are very highly refined. Unlike the harsh oils of years ago that burned leaves and could only be used on deciduous trees during the months they were leafless, the new oils are so “light” they can be used to control a wide variety of insects even on many bedding plants.

Note that it is always wise to test a material on a small portion of the plant first to check for damage before spraying the entire plant.

### **Botanical Pesticides**

Botanical pesticides, although they are derived from plants, are not necessarily better than synthetic pesticides. Botanicals can be easily degraded by organisms in the environment; however, plant-derived pesticides tend to kill a broad spectrum of insects, including beneficials, so they should be used with caution. The most common botanical is pyrethrum, made from crushed petals of the pyrethrum chrysanthemum flower. “Pyrethrins” are the active ingredient in pyrethrum, but “pyrethroids” such as resmethrin and permethrin have been synthesized in the laboratory and are much more powerful and long-lasting than the pyrethrins. Neem, another botanical pesticide, is discussed above under “Repellents.” Some botanicals, such as nicotine or sabadilla, can be acutely toxic to humans if misused, and rotenone is very toxic to fish. The same care must be used with these materials as with conventional insecticides.

## **How to Select a Pesticide for an IPM Program**

When contemplating the use of a pesticide, it is prudent to acquire a Material Safety Data Sheet (MSDS) for the compound. MSDS forms are available from pesticide suppliers and contain some information on potential hazards and safety precautions. See the Recommended Readings section of this manual for other reference materials on pesticides. Appendix G lists organizations that provide information on pesticide toxicity.

The following criteria should be used when selecting a pesticide: safety, species specificity, effectiveness, endurance, speed, repellency, and cost.

### **Safety**

This means safety for humans (especially children), pets, livestock, and wildlife, as well as safety for the overall environment. Questions to ask are as follows:

- What is the acute (immediate) and chronic (long-term) toxicity of the pesticide? Acute toxicity is measured by the “LD<sub>50</sub>,” which is the lethal dose of the pesticide required to kill 50% of the test animals (measured in milligrams of pesticide per kilogram of body weight of the test animal). The higher the LD<sub>50</sub> value, the more poison it takes to kill the target animals and the less toxic the pesticide. In other words, high LD<sub>50</sub> = low toxicity. Chronic toxicity refers to potential health effects from exposure to low doses of the pesticide for long periods of time. Chronic effects can be carcinogenic (cancer-causing), mutagenic (causing genetic changes), or teratogenic (causing birth defects). Sources of information on health effects of pesticides are provided in Appendix G.
- How mobile is the pesticide? Is the compound volatile, so that it moves into the air breathed by people in the building? Can it move through the soil into the groundwater? Does it run off in rainwater to contaminate creeks and rivers?
- What is the residual life of the pesticide? How long does the compound remain toxic in the environment?
- What are the environmental hazards listed on the label? What are the potential effects on wildlife, beneficial insects, fish, or other animals?

### **Species Specificity**

The best pesticides are species-specific; that is, they affect just the group of animals or plants you are trying to suppress. Avoid broad-spectrum materials that kill many different organisms because they can kill beneficial organisms that keep pests in check.

---

When broad-spectrum materials must be used, apply them in as selective a way as possible by spot-treating.

### **Effectiveness**

This issue is not as straightforward as it might seem, since it depends on how effectiveness is being evaluated. For example, a pesticide can appear to be very effective in laboratory tests because it kills 99% of the test insects. But in field tests under more realistic conditions, it may also kill 100% of the pest's natural enemies. This will lead to serious pest outbreaks at a later date.

### **Endurance**

A pesticide may have been effective against its target pest at the time it was registered, but if the pest problem is now recurring frequently, it may be a sign that the pest has developed resistance to the pesticide or, stated otherwise, that the pesticide has lost its endurance.

### **Speed**

A quick-acting, short-lived, more acutely-toxic material might be necessary in emergencies; a slow-acting, longer-lasting, less-toxic material might be preferable for a chronic pest problem. An example of the latter is using slower-acting boric acid for cockroach control rather than a quicker-acting but more toxic organophosphate.

### **Cost**

This is usually measured as cost per volume of active ingredient used. Some of the newer, less-toxic microbial and botanical insecticides and insect growth regulators may appear to be more expensive than some older, more toxic pesticides. But the newer materials tend to be effective in far smaller doses than the older materials—one container goes a long way. This factor, together with their lower impact on the environment, often makes these newer materials more cost effective.

### **Pesticide Use Guidelines**

In addition to becoming informed about the characteristics of the material itself, it is important to develop guidelines to be followed each time a pesticide is used. Prepare a checklist to be used each time an application is made. The following are important items to include on the checklist:

- Make sure the pesticide is registered for use in the state. (Pesticides can be registered in some states and not in others.) What are the laws regarding its use?

### **Notification and Posting**

School systems have the responsibility to inform occupants when they may be exposed to pesticides. Unless it is an emergency situation, the applications should be performed when only maintenance staff are present and the building is otherwise unoccupied. Notifications of all pending treatments using a pesticide should be sent home to the students' parents and be distributed to all school staff prior to the treatment.

Schools should direct concerned parents to the school pest manager for more specific information. A voluntary registry of individuals with medically-documented problems that could be adversely affected by exposure to pesticides should be kept at each school's office and in the pest manager's office for special contact in emergency situations.

Post all areas to be treated or that have been treated. If posting is a new practice at the school, the new policy should be explained in the context of the IPM program so that all affected parties will understand that the posting is part of a new overall effort to reduce pesticide use and not the result of new or heavier pesticide use.

- **READ THE PESTICIDE LABEL.** Follow its restrictions and directions for use, labeling, and storage exactly.
- If required, secure a written recommendation from a licensed pest control adviser for using the pesticide.
- Make sure that all safety equipment and clothing (e.g., neoprene gloves, goggles, respirator, hat, and other protective coverings as necessary) is available and worn when the pesticide is used.
- Verify that the person doing the application is certified and/or qualified to handle the equipment and material chosen and has been adequately trained.
- Make sure application equipment is appropriate for the job and properly calibrated.
- Confine use of the material to the area requiring



---

treatment (spot-treat).

- Keep records of all applications and copies of MSDS sheets for all pesticides used.
- Monitor the pest population after the application to see if the treatment was effective and record results.
- Be prepared for all emergencies and compile a list of whom to call for help and the kinds of first aid to be administered before help arrives. Place the list in an accessible area near a phone.
- Dispose of pesticides properly. DO NOT pour pesticides down the drain, into the toilet, into the gutter, or into storm drains! If you are unsure about how to dispose of the pesticide, call the manufacturer or your local utility company that handles sewage and storm drains.

Reregistration Falls Further Behind and Exposure Effects Are Uncertain. U.S. General Accounting Office, Washington, D.C. 41 pp.

Olkowski, W., S. Daar, and H. Olkowski. 1991. Common-Sense Pest Control: least-toxic solutions for your home, garden, pets and community. Taunton Press, Newtown, CT. 715 pp.

## **BIBLIOGRAPHY**

Bio-Integral Resource Center (BIRC). 1996. 1997 directory of least-toxic pest control products. *IPM Practitioner* 18(11/12):1-39.

Hembra, R.L. 1993. GAO Report to the Chairman, Subcommittee on Toxic Substances, Research and Development, Committee on Environment and Public Works, U.S. Senate Lawn Care Pesticides

---

# CHAPTER 5

## IPM FOR ANTS IN SCHOOLS

### INTRODUCTION

Ants become pests when they invade buildings searching for food or when they protect plant-feeding insects like aphids and scales from attack by their natural enemies. It is neither desirable nor practical to try to eliminate most ants from their outside habitat, so management efforts should aim to keep them out of structures and to prevent them from tending plant-feeding insects.

Regardless of the damage they produce directly or indirectly, it is important to recognize that an ant species can be both pestiferous and beneficial. Ants kill numerous other pest insects, including fly larvae and termites, and they aerate the soil outdoors and recycle dead animal and vegetable material. From that point of view, ants provide an ecological cleansing and fertilization service of considerable importance.

Note that it is not within the scope of this project to address either carpenter ants or fire ants.

### IDENTIFICATION AND BIOLOGY

Ants are social insects and live in colonies. The colony is divided into three main castes: workers, queens, and males. The workers enlarge and repair the nest, forage for food, care for the young and queen, and defend the colony. The queens lay eggs, and the males serve only to mate with the queens.

Ants pass through four stages of development: egg, larva, pupa, and adult (see Figure 5-1). Queens mate with males and lay eggs that hatch into blind, legless larvae. The

larvae are fed and cared for by worker ants. At the end of the larval stage they turn into pupae which do not feed. Eventually, the adult ants that we recognize emerge from the pupal cases.



Argentine Ant

It is important to identify your problem ant before you design your management program because ants differ in their habits and food preferences. Use Box 5-A and Table 5-1 to assist you.

### DAMAGE

Certain species of ants, such as thief, Pharaoh, and Argentine ants, are particularly prone to getting into food. Inside buildings, these ants are mainly a problem of nuisance since they almost never sting or bite.

Since ants walk over many different kinds of material and sometimes feed on dead animals and insects, it is possible that they can carry disease-causing organisms to human food. At the very least you should assume that food they have swarmed over has been exposed to organisms that can cause spoilage, and the food should be thrown away.

### DETECTION AND MONITORING

Visual inspection is the most useful monitoring technique for ants, and can be very useful in preventing an incipient ant infestation. Often it takes detective work and ingenuity to discover where the ants are coming from.

- Begin by constructing a map of the school on which you can note problem areas and areas needing repair.
- Kneepads, a mirror, and a good flashlight will be helpful.
- Carry a caulking gun and seal all small holes found during the inspection.
- Keep accurate records during the monitoring program to help formulate an IPM plan and evaluate its effectiveness.
- Ants are most likely to be pests indoors, especially in kitchens and food preparation areas.

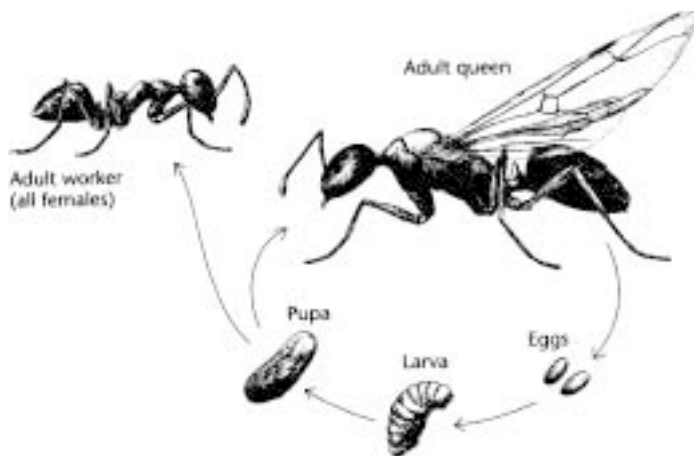

Figure 5-1. The Life Cycle of the Argentine Ant

- An ant infestation may indicate that there has been a change in the methods of storing food or food waste that allows increased access for ants. Note how food and food wastes are stored in the area, and whether refuse containers are emptied and cleaned regularly. Check recycling bins to see if recyclables have been cleaned before storage.
- Speak to the kitchen staff and custodians to learn more about the problem from their perspective.
- Ants can be attracted to snacks kept in classrooms or the teachers lounge, or to something like a sweet drink accidentally spilled on the floor.

## MANAGEMENT OPTIONS

### Habitat Modification

The environment should be modified to reduce ant entryways and access to food. With good quality materials and a careful job, the alteration will be permanent and make a long-term impact on the number of ant invasions.

### Caulking

- Caulk actual and potential entryways with a silicone caulking compound.
- Use mildew-resistant caulk in moist areas.
- It is not necessary or practical to seal all cracks, but

begin with the access point that the current trail of ants is using.

- Always carry caulk when making inspections and seal as many cracks as time allows, especially those around baseboards, cupboards, pipes, sinks, toilets, and electrical outlets. Silicone caulks are flexible, easy to apply, and long-lasting.
- Weather-strip around doors and windows where ants may enter.

### Sanitation

Sanitation eliminates food for ants. Thorough daily cleaning of school kitchens and food preparation areas is essential.

- Sweep and mop floors.
- Drain all sinks and remove any food debris.
- If children regularly receive snacks in classrooms, these floors should be vacuumed and/or mopped daily.
- Periodically give all food preparation areas an all-inclusive cleaning, focusing on areas where grease and food debris accumulate. These include drains, vents, deep fat fryers, ovens, stoves, and hard-to-reach areas behind or between appliances. Thoroughly vacuum the area with a powerful vacuum.
- At the end of each day, remove from the building all garbage containing food.

### Box 5-A. Identifying Ants

Since ant species can differ widely in their food requirements, it is important to identify the species before choosing a bait. Like all insects, ant bodies are divided into head, thorax, and abdomen. Unlike many other insects, however, ants have a constriction between the thorax and abdomen that gives them their pinched-waist appearance. The constricted part of the abdomen is called the pedicel, and the fat, main part of the abdomen is called the gaster. An important

identification characteristic is the number of segments or “nodes” in the pedicel (see the figure below). For example, one-node ants include the Argentine ant and odorous house ant. Two-node ants include the Pharaoh ant, pavement ant, and little black ant. Final identification is made from size, color, other body characteristics, habits, or other information. Table 5-1 provides more information to help you identify your problem ant.

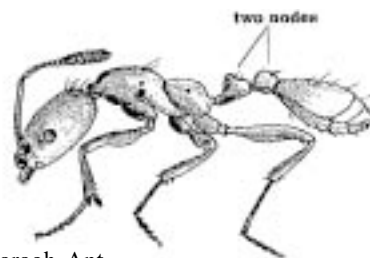
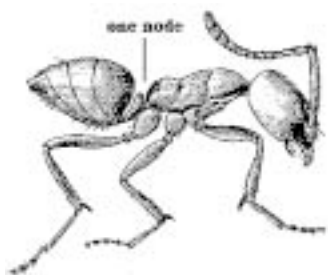

Pharaoh Ant,  
*Monomorium pharaonis*

**Table 5-1. Common House-Invading Ant Species**

Species	# of nodes in the pedicel <sup>a</sup>	Description of Workers	Habits	Distribution
Argentine Ant <i>Linepithema humile</i> (formerly known as: <i>Iridomyrmex humilis</i> )	1	light to dark brown; around 3/32 to 1/8 inch (2.2-2.8 mm)	frequent house invader; nests in a wide variety of places outdoors and inside; multiple queens; prefers honeydew from aphids, scales, etc., but is an opportunistic species and will feed on other sweets, protein, and grease	MD, west to IL, TX, AZ, CA, OR, WA, HI
Pharaoh Ant <i>Monomorium pharaonis</i>	2	small, around 1/16 to 3/32 inch (1.5-2 mm); yellowish to red; often confused with thief ant, but has 3 segments in the club-like structure at the end of the antennae	nests in any secluded spot; prefers temperatures between 80° and 86°F; frequent house invader; often found around kitchen and bathroom faucets where it obtains water; feeds on sweets but prefers fatty foods, eats dead insects; also predacious on bedbugs, white grubs, boll weevils, and other insects	throughout U.S. and Canada
Thief Ant <i>Solenopsis molesta</i>	2	very small, around 1/32 to 1/16 inch (1-1.5 mm); yellowish; often confused with Pharaoh ant, but has 2 segments in the club-like structure at the end of the antennae	often lives in association with other ants as predator of brood; omnivorous but prefers grease or high protein foods over sweets; frequent house invader, may nest indoors in cracks and cupboards; more likely to have an indoor nest than the Pharaoh ant	throughout U.S.
Little Black Ant <i>Monomorium minimum</i>	2	very small, around 1/32 to 1/16 inch (1-1.5 mm); jet black	small craters of fine soil mark nest openings in ground; will also nest in the woodwork or masonry of buildings; omnivorous; occasional house invader	throughout U.S.
Big-Headed Ant <i>Pheidole</i> spp.	2	around 1/16 to 1/8 inch (1.5-3 mm); yellowish or light to dark brown; head large	nests in and around the house; prefers sweets or high protein foods	NY to NE, south to FL & AZ
Pavement Ant <i>Tetramorium caespitum</i>	2	around 1/8 inch (2.5-3 mm); light to dark brown or blackish; head & thorax furrowed by parallel lines	nests under stones & edges of pavement, in winter will nest in houses in crevices adjacent to a heat source; slow-moving; tends aphids for their honeydew; feeds on seeds; insect remains, and greasy materials	common along the Atlantic seaboard and in central CA; sporadic in Midwest
Odorous House Ant <i>Tapinoma sessile</i>	1	around 1/16 to 1/8 inch (2-3 mm); brownish to black; foul odor when crushed; darker than Argentine ant	frequent house invader; nests in a wide variety of places outdoors and inside; multiple queens; colonies are more localized than those of the Argentine ant; food habits are similar to the Argentine ant	throughout U.S.

<sup>a</sup> See Box 5-A.

- At the end of each day, remove from the building all garbage containing food.
- Use soapy water to wash any bottles, cans, wrappings, and other items that have food residues clinging to them before storing them for recycling.
- If dishes cannot be washed right away, it is very important that they at least be rinsed to remove all food debris.
- Place garbage in sealed plastic bags before it is placed into a rodent-proof dumpster (see Chapter 12) or other storage receptacle.
- Keep garbage cans and dumpsters as clean as possible to deny food to ants, roaches, flies, mice, and rats.

**Proper Food Storage**

- Food not kept in the refrigerator should be kept in containers that close tightly. Cardboard boxes and paper are not ant- or roach-proof.

- Although refrigerator storage is usually safe, ants sometimes get into refrigerators and freezers even when the seals appear intact. When this occurs, a light, temporary coating of petroleum jelly on the edge of the refrigerator seal will exclude the ants. Once ants have left, the petroleum jelly can be wiped off. Freezer storage is safe, because any ants that manage to get past the seal will die.
- Screw-top jars are ant-proof only if the lid has a rubber seal since the ants can follow the spiral ridges to get into the jar.
- Glass containers with rubber gaskets or plastic containers with tight-fitting, snap-top lids are also ant-proof.
- As soon as they arrive in the building, transfer food packaged in paper to plastic or glass containers. To prevent roach problems, do not bring shipping boxes into the food preparation area. Instead, boxes should be broken down and stored away from the kitchen in a cool area until removed for recycling.
- Advise students and teachers not to leave unsealed food items in their desks or lockers. Any food kept in offices or classrooms should be stored in ant- and roach-proof containers.

### Physical Controls

Before ants become highly visible in long columns marching through a room, there have been a few “scouts” wandering around looking for food or water. It is always a good idea to kill these scouts before they have a chance to go back to the colony and summon their nest mates. Instruct teachers and staff to squash lone, wandering ants whenever they see them.

### Vacuuming

- Use a strong vacuum to vacuum up trails of ants effortlessly and quickly.
- Although the dust in the vacuum bag will usually clog the ants’ breathing apparatus and suffocate them, you can vacuum up a tablespoon of cornstarch to be sure they die.

### Detergent Barrier

Temporary “moats” of detergent and water may be useful during heavy ant invasions.

- Containers of food or food waste which must remain open during working hours can be placed in larger, shallow pans filled with water mixed with a small amount of detergent. Water alone is insufficient, since ants can float across using the water’s surface tension;

the detergent breaks the surface tension, and the ants sink and drown.

- Use this technique to protect potted plants from ants that may be attracted to nectar produced by the plant or to honeydew produced by plant-feeding insects. Elevate the pot above the detergent-and-water mixture by placing it on an overturned saucer. Make sure the plant is not touching anything that ants could use as a bridge.

### Flooding

Ants sometimes build nests in potted plants. Rather than disposing of the soil and the plants, water the soil until the ants are driven out.

- It is easiest to do this outside where the ants will find their way to another suitable nesting place, but if this is impractical, use a container of loose dry soil or compost to catch the ants.
- Place the infested pot in a wide and deep container, and use a stick to make a bridge from the pot to the ground or to the bucket of soil or compost.
- Water the plant heavily. As the soil becomes saturated, the ants will pick up their white pupae and look for drier ground.
- Many ants may walk out on the stems and leaves, but eventually they will find the bridge.
- When the trail of ants leaving the pot has disappeared, the plant can be drained and returned to its usual location.

### Chemical Controls

If non-chemical methods alone prove insufficient to solve the problem, then integrating a pesticide into your management program may be warranted. For information on the hazards of various pesticides and on how to select an appropriate pesticide for your situation, consult Appendix G for a list of resources.

Pesticides must be used in accordance with their EPA-approved label directions. Applicators must be certified to apply pesticides and should always wear protective gear during applications. All labels and Material Safety Data Sheets (MSDS) for the pesticide products authorized for use in the IPM program should be maintained on file. Do not apply these materials when buildings are occupied, and never apply them where they might wash into the sanitary sewer or into outside storm drains.

When treating ants, only crack and crevice treatments with dust or bait formulations should be used. See Box 5-B for tips on controlling specific ant species.

---

## Detergent and Water

When ants invade a classroom or food preparation area, the best emergency treatment is detergent and water in a spray bottle. This mixture will quickly immobilize the ants, and they can be wiped up with a sponge and washed down the drain. Each classroom, cafeteria, and food preparation area should be equipped with such a spray bottle so teachers and staff can safely deal with emergencies.

## Boric Acid

Boric acid is one of the most valuable chemical control tools in an integrated program against ants. It is formulated as a dust, gel, and aerosol. It acts as a stomach poison, and because it is a general enzyme inhibitor, ants are unlikely to become resistant to this material. If kept dry, boric acid dust remains effective for the life of the building.

- When applying boric acid dust, wear a dust mask to avoid breathing the material.
- Use a bulb duster to apply a light dusting in cracks and crevices. This is superior to dusting large, open areas.
- Boric acid is approved for crack and crevice treatment in kitchen and food preparation areas.
- Boric acid can be blown into wall voids and spaces behind and under cabinets.

## Diatomaceous Earth and Silica Aerogel

These are insecticidal dusts that can be used for ant control. Diatomaceous earth is made from fossilized diatoms, and silica gel is produced essentially from sand. Both kill insects by desiccation; they absorb the wax and oil from the insect's outer covering, which causes dehydration and death. Although these materials are not poisonous to humans directly, the fine dust travels freely through the air and can be irritating to the eyes and lungs; therefore, use a dust mask and goggles during application.

Diatomaceous earth and silica aerogel are especially useful in wall voids and similar closed spaces. During construction and remodeling these dusts can be blown into such spaces, and in finished buildings they can be applied by drilling tiny holes in the walls. These dusts are also useful in crack and crevice treatments.

Some products combine diatomaceous earth or silica gel with pyrethrins. The pyrethrins provide a quick knock-down of the ants, and the dusts provide the

long-term control.

## Ant Baits

Baits greatly reduce the amount of pesticide that must be used to kill ants. Foraging ants take the bait back to the nest to feed to other members of the colony, and if the bait kills the queen, the colony will die. Even if the queen is not killed, baits will usually stop an ant invasion. If a colony has been starved by effective sanitation measures, baits will be more readily accepted.

Always place baits out of sight and reach of children, or, if this is not possible, use baits at night or on weekends and remove when children are in school.

Some ants are very susceptible to baits, some are less so. There are many reasons for these differences, only some of which we understand. If you are having difficulty in controlling your problem ant(s) with a bait, the following points may be helpful:

- It is important to correctly identify the species of ant that is invading the school since each species differs in its food preferences. Some baits use a sweet attractant and some use a protein or oily attractant, so the bait must be matched with the ant. If you cannot determine the type of attractant by looking at the label, call the manufacturer for more information. You should also ask if the company has data to support the efficacy of their product against the ant species you are dealing with.
- After setting out bait, observe closely to see if the target ant is taking the bait.
- Ant colonies have changing nutritional requirements that can pose problems in baiting. A colony that accepted a protein bait one week may be more interested in a sugar bait the next.
- The nesting and foraging environment can also affect bait acceptance. Ants nesting and foraging in dry areas will be more interested in baits with a high water content than will ants nesting in moist environments.
- When there are several competing ant species in one area, ants that you are not trying to control may attack your bait more readily than the pest ant and in some cases prevent the pest ant from getting to the bait.
- Do not spray pesticides when using baits. Bait stations contaminated with pesticide are repellent to ants, and sprays disperse the ant infestation, making it harder to place baits effectively.

### Box 5-B. Tips For Controlling Specific Ants

- Argentine Ant—Since it is practically impossible to eradicate the colony/colonies, concentrate efforts on getting rid of the present ant invasion. Sanitation is key. Although its favorite food is honeydew from aphids, scales, psyllids, etc., the Argentine ant will feed on almost anything. Outside, this ant nests under rocks and logs or in shallow holes in the ground, and it frequently moves its nest to escape unfavorable environmental conditions. Indoors it nests in wall voids, potted plants, under loose tiles, behind baseboards, etc., usually close to moisture sources. Argentine ants come indoors searching for food or looking for water when it's too dry outside, but they also come in to escape wet conditions outdoors. For control, use commercial bait stations along ant trails and around building perimeters.
- Pavement Ant—Start inspections at the ground floor or subfloor level because even if pavement ants are on upper floors, they usually originate from ground floor and outside colonies. Follow trails of ants to locate colony/colonies. Outside, trails are usually hidden by grass or mulch next to the building foundation or the edges of pavement. Inside, you can often find trails under edges of carpets along the tack strip. Pavement ants use electrical wires, conduit, and water pipes as highways throughout the building. Performing an inspection at night around 10 or 11 PM can be useful since pavement ants are most active at night and you are more likely to find trails that

will lead back to the colony. Outside, piles of soil near slabs and concrete are a good indication of underground galleries. Effective pavement ant control requires caulking cracks and crevices and placing baits in the path of ant trails near colonies. Observe carefully to ensure ants are feeding on bait. If not, change baits until you find one they will accept. Baiting is a slow control process and will take several days or longer for satisfactory treatment and will probably not eliminate the problem.

- Pharaoh Ant—This is a tropical ant that likes inaccessible dark places with a relative humidity of 80% and a temperature of around 80°F. Workers are attracted to baits that contain protein, peanut butter oil, liquid sugars, and granulated silkworm pupae. Place the baits in door or window frames, light switches, and fuse boxes; at floor level in corners and along baseboards; near toilets, sinks, drains, heating pipes, and radiators; and in food cupboards. In warmer areas of the U.S., Pharaoh ants may nest indoors and forage outside. If you find foragers outside, place baits in areas of high activity. Use enough bait stations so that feeding will not deplete the bait before the colonies are dead. It may also be advantageous to use baits that combine 2 different attractants or use several different kinds of bait at once. A Pharaoh ant bait containing the insect growth regulator methoprene has been pulled from the market by the manufacturer in order to formulate the bait to be attractive to more ant species. Workers are unaffected by methoprene, but the queen is sterilized and no new larvae are produced. Although this kind of bait can take 10 weeks or more to kill a colony, it will be a useful ant management tool when it returns to the market.

- Place bait stations along foraging trails, but do not disturb ant trails between the nest and the bait. Killing the ants or disturbing the trails prevents the ants from taking enough bait back to the colony to kill nest mates.
- Do not put out bait until you have an ant problem. If you use baits preventively you may attract ants into the building.
- Some baits come packaged in plastic disc “bait stations” that come with double-sided tape so they can be glued to various surfaces out of view. It is

important to remove bait stations once the ant problem is under control because they are ideal harborage for cockroaches. Likewise, if there is bait left in them, it may eventually attract ants back into the building. Other baits come in granular or gel formulations that can be injected into wall voids through small holes. Gel baits can also be placed near ant trails in unobtrusive places where they will not be disturbed.

### BIBLIOGRAPHY

- Bio-Integral Resource Center (BIRC). 1996. 1997 directory of least-toxic pest control products. *The IPM Practitioner* 18(11/12):1-39.
- Gulmahamad, H. 1995. Argentine ant: the Ghenghis Khan of the ant

- 
- world. Pest Management 14(6):9-15.
- Hedges, S.A. 1995. Pavement ant control in commercial buildings. Pest Control Technology 23(5):50-51,54,65,58.
- Mallis, A. 1982. Handbook of Pest Control. Franzak and Foster, Cleveland, OH. 1,101 pp.
- Markin, G.P. 1970. The seasonal life cycle of the Argentine ant, *Iridomyrmex humilis* (Hymenoptera: Formicidae), in southern California. Annals of the Entomological Society of America 63(5):1238-1242.
- Newell, W. and T.C. Barber. 1913. The Argentine ant. Bureau of Entomology, U.S. Dept. of Agriculture, Washington, D.C., Bull. 122. 98 pp.
- Olkowski, W., S. Daar, and H. Olkowski. 1991. Common-Sense Pest Control: Least-toxic solutions for your home, garden, pets and community. Taunton Press, Newtown, CT. 715 pp.
- Quarles, W. 1995. Baiting Pharaoh or Argentine ants. Common Sense Pest Control Quarterly 11(4):5-13.
- Tucker, J. 1995. Why ants are sometimes finicky with certain baits. Pest Control Technology 23(9):94,98.





---

# CHAPTER 6

## IPM FOR COCKROACHES IN SCHOOLS

### INTRODUCTION

Cockroaches are the most important pest in schools, homes, restaurants, and other indoor spaces. They consume human foods and contaminate them with saliva and excrement, produce secretions that impart a characteristic fetid odor, and shed skin scales that cause allergic reactions.

### IDENTIFICATION AND BIOLOGY

Except for size and markings, all cockroaches are similar in overall appearance: flattened cricket-like insects with long antennae. The most common cockroaches in the United States are the German, brownbanded, oriental, American, and smoky brown cockroaches. See Table 6-1 for a list of their important characteristics. Figure 6-1 is a pictorial key to these and some other common roaches.

The Asian cockroach (*Blattella asahinai*) has recently become established in Florida. Because this species flies readily and has a greater reproductive potential than the German roach, it may become a serious pest in other areas in the future.

In general, roaches like to squeeze into cracks and crevices in warm places, but as you can see from Table 6-1, the specifics of their habitat differs with the species of roach. The American, oriental, and smoky brown roaches can all live outside, but are forced indoors by cool weather or lack of food.

The life cycle of the cockroach begins with the egg case, or ootheca. In some species the female carries the egg case around with her until just before the eggs hatch and in other species she deposits it in a sheltered place (see Table 6-1). Roaches undergo a gradual metamorphosis in their life cycle. An immature roach, or nymph, looks very much like an adult, but is smaller and wingless. As the nymph grows, it sheds its skin (molts) a number of times. The number of days it takes a cockroach to mature is affected by the temperature: the warmer it is (up to a certain point), the faster the roach grows.

Cockroaches prefer carbohydrates to protein and fat. They will discriminate among foods if given a choice, but when hungry they eat almost anything. Some products not normally considered food—starch-based paints, wallpaper paste, envelope glue, and bar soaps—

contain carbohydrates, and hence are food for roaches.

Cockroaches are generally active at night and remain hidden during daylight. Daylight sightings usually indicate a high population which has overrun available harborage, or a recent emigrant roach seeking shelter.

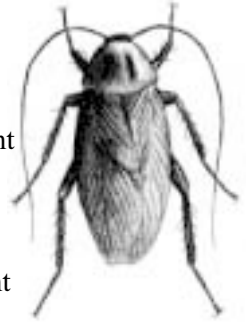

German Roach

### DAMAGE

Cockroaches have not yet been proven to be involved in the natural transmission of any particular human pathogen (this means that they are not a necessary part of the life cycle of a disease organism); however, evidence has been collected that clearly indicates that cockroaches can mechanically transmit a long list of disease-causing organisms. Because roaches wander at will through all types of organic wastes, then travel over kitchen counters, cooking utensils, plates, and silverware, their presence indicates potential contamination of foods and utensils. They can also trigger allergic reactions in sensitive individuals.

### DETECTION AND MONITORING

Efforts to control roaches should begin with a monitoring program. Roaches are rarely dispersed everywhere throughout the building. Once they have located a suitable harborage, they tend to concentrate there, leaving periodically to forage for food and water, then returning to the same place. Thus, the first step in monitoring is to locate these roach concentrations. Note that the places where you see signs of roaches are often where they forage and not where they harbor. You may also need to inspect adjacent rooms (above, below, beside). Monitoring must continue after treatment has begun to determine whether control efforts have satisfactorily reduced the cockroach population.

### Establishing a Communication System

A successful monitoring program depends on clear and frequent communication with principals, teachers, custodians, and food service personnel. These people

### Trapping

**Table 6-1. Characteristics of Common Coackroach Species**

Common and scientific names	German ( <i>Blatella germanica</i> )	Brownbanded ( <i>Supella longipalpa</i> )	American ( <i>Periplanta americana</i> )	Oriental ( <i>Blatta orientalis</i> )	Smoky brown ( <i>Periplaneta fuliginosa</i> )
<b>Color and distinctive markings</b>	Light brown with 2 dark stripes on the pronotum (platelike structure behind the head on the back).	Tan with faint V-shaped lighter bands on wings. Nymph has 2 distinct brown bands running crosswise on body.	Reddish brown throughout with a pale band on the edge of the pronotum.	Dark red-brown-black throughout.	Dark brown to black. The wings of both sexes cover the abdomen.
<b>Length of adult</b>	1/2 to 5/8 inch	3/8 to 1/2 inch	1 1/2 to 1 3/4 inch	1 1/4 inch	1 1/2 inch
<b>Average # of eggs/egg case<sup>1</sup></b>	37	16	14	18	17
<b>Life cycle from egg to adult</b>	64-251 days	143-379 days	320-1071 days	316-533 days	324-890 days
<b>Reproduction characteristics</b>	Female carries egg case until about 1 day before hatching, then drops it anywhere.	Egg case glued to rough, dark areas such as ceilings, beneath furniture, or in closets; will glue egg cases on top of one another.	Egg case deposited in sheltered area on or near floor, usually close to food and concealed in debris. Needs high humidity to hatch.	Female uses existing crevices in which to secure and conceal egg case; usually covers egg case with debris or sometimes with fecal pellets.	Female carries egg case until 3-4 days before hatching, then deposits in a sheltered area.
<b>Preferred habitat</b>	Usually found in kitchen and bathroom. Prefers dark voids such as cracks and crevices not more than 3/16" wide, especially in warm moist areas like <ul style="list-style-type: none"> <li>• food preparation areas</li> <li>• undersides of tables, kitchen equipment, and service counters</li> <li>• kitchen cupboards</li> <li>• motor compartments of refrigerators</li> <li>• electrical fuse boxes</li> <li>• spaces under broken plaster or behind sinks</li> </ul> During warm periods they are found outdoors in and around dumpsters and other waste receptacles.	Favors cracks and crevices but prefers them in warm dry areas throughout the building. Prefers high locations in heated buildings, but can also be found <ul style="list-style-type: none"> <li>• under furniture</li> <li>• in appliances that generate heat</li> <li>• on the undersides of counters that support appliances that generate heat</li> <li>• behind pictures and picture frames,</li> <li>• behind wallpaper</li> <li>• in ceiling light fixtures,</li> <li>• in telephones</li> <li>• in desks and dressers</li> <li>• in boxes</li> <li>• in piles of debris or stored material in closets</li> </ul>	Usually found in basements or on first floor. Prefers warm, moist areas <ul style="list-style-type: none"> <li>• around furnaces or heating ducts</li> <li>• in steam pipe catacombs</li> <li>• in drainage manholes and grease traps</li> <li>• in sewers</li> </ul> Can live outside during warm weather.	Found in areas with excessive moisture; usually in groups in sheltered, but more or less open spaces                     Found in cooler areas of a building such as <ul style="list-style-type: none"> <li>• basements,</li> <li>• cellars</li> <li>• service ducts</li> <li>• crawl spaces</li> </ul> Can also tolerate hot, dry locations such as <ul style="list-style-type: none"> <li>• radiators</li> <li>• ovens</li> <li>• hot-water pipes</li> <li>• under floor coverings</li> </ul> Can tolerate colder temperatures, and is capable of overwintering out-of-doors in colder regions of the U.S.	Found in basements or on the first floor of buildings in crevices in warm, moist areas such as <ul style="list-style-type: none"> <li>• food preparation areas</li> <li>• bathrooms</li> </ul> Also lives outside in woodpiles and organic debris during warm weather.
<b>Natural enemy parasites<sup>2</sup></b>	Miniwasp <i>Tetrastichus hagenowi</i>	Miniwasps <i>Comperia merceti</i> and <i>Anastatus blattidarum</i>	Miniwasp <i>Tetrastichus hagenowi</i>	Parasitic wasp <i>Evania appendigaster</i> and miniwasp <i>Tetrastichus hagenowi</i>	Miniwasp <i>Tetrastichus hagenowi</i>

<sup>1</sup>The number actually hatched can be fewer.

<sup>2</sup>Other natural enemies include spiders, ants, wasps, beetles, mantids, dragonflies, centipedes, scorpions, toads, geckos, and rats.

Figure 6-1. Pictorial Key To Some Common Adult Cockroaches

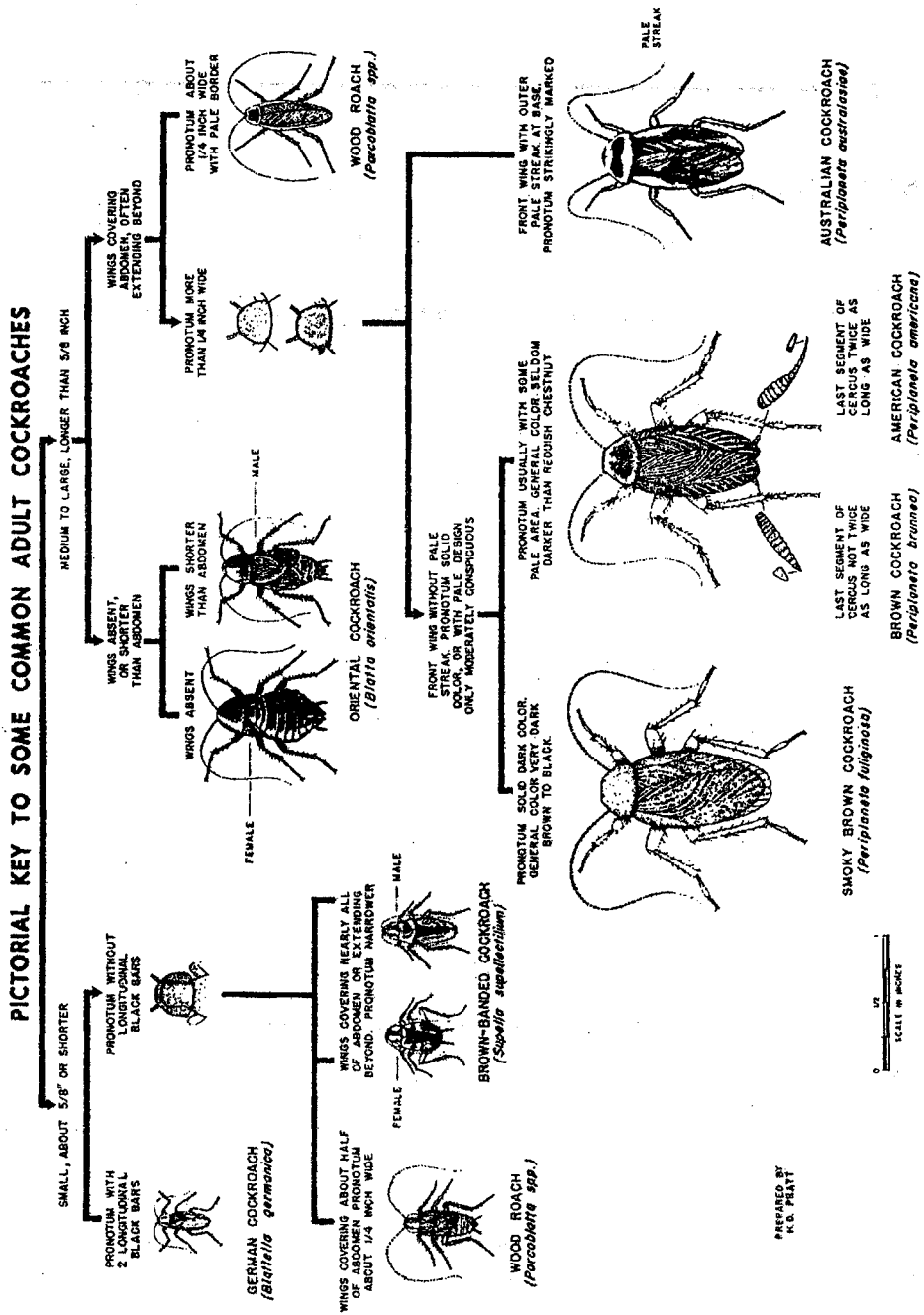

---

have first-hand knowledge of pest sightings, sanitation problems and other contributing factors, as well as the history of control measures in their buildings. With a small investment in time, school personnel can be trained to serve as additional sources of valuable information for the monitoring program.

Make sure personnel understand the following:

- the goals of the cockroach IPM program and the role monitoring plays
- their role in the IPM program (what they can do to help reduce the number of cockroaches and the kind of information they can provide)
- how they can communicate with the pest management technicians (you may want to post log sheets in various locations where people can write down pest sightings and other information)

### Visual Inspection

- Construct a map of the premises.
- Mark all the locations where roaches are sighted, or where you see signs of their presence, such as fecal matter, shed skins, egg cases, etc.
- Mark any places that are likely harborage or food sources.
- Note any sanitation problems such as food or grease spills, food or grease buildup behind or under kitchen equipment, or improper garbage disposal procedures.
- Note any leaks or condensation.
- Look for roach entry points such as holes in walls or floors, or around pipes where they enter a wall, around electrical conduits, in vents, etc.
- Use the list of preferred habitats in Table 6-1 to help you decide where to inspect, and see Box 6-A for a list of monitoring tools.

### When to Inspect

Schedule at least one inspection after dark. This will give you more information about where the cockroaches are and the level of sanitation at a time when the building is supposed to be clean. Ask custodians to leave the lights on for your inspection. If you have to enter a dark room, turn on the lights and remain motionless for a few minutes. The roaches will soon resume their activity. Once you see the roaches, you can move. Your movement will frighten them into running back to their hiding places. Inspect these spots to determine whether they are actual harborage

or pathways to harborage in another area. Note this information on your map.

### Flushing with a Repellent Insecticide

This should not be necessary, especially if you conduct thorough inspections and include at least one night inspection. Do not use this technique in rooms with cockroach traps, baits, or bait stations because roaches will avoid them after you have sprayed.

If you do encounter situations where it is necessary to flush roaches from a suspected hiding place, use just a 1-second blast from a small can of aerosol pyrethrin; no more is required for effective flushing.

### Where to Inspect

When inspecting for roaches, check the following areas:

- in corners of rooms at floor or ceiling level
- under, behind, and around sinks, toilets, showers, bathtubs, drinking fountains, ice machines, dishwashers, beverage dispensers, floor drains
- the engine compartments of refrigerators, beverage dispensers, toasters, air conditioners, and other equipment
- in and under stoves, hot plates, heaters, and near hot water pipes and radiators
- in and around stove vents, hoods, grease traps
- between equipment and walls
- behind picture frames, mirrors, bulletin boards, wall-mounted shelving
- in false ceilings, vents, light fixtures, ceiling-mounted fixtures, and railings
- in cupboards, linen closets, drawers, filing cabinets, lockers, cluttered areas
- in and under cash registers, computers, telephones, electric clocks, televisions, switchboxes, and fuse boxes
- in and around check-out stands, vegetable bins, and meat counters
- cracks and crevices in walls, baseboards, etc.
- under edges and in corners of equipment, tables, desks, counters, and other furnishings and equipment
- indoor and outdoor trash containers, dumpsters, and recycling containers
- loading docks, and storage areas where incoming food, supplies, equipment, and other potential sources of migrating roaches are received and stored

A visual inspection may not provide all the information you need about where roaches are harboring or how many roaches there are; you may need to use sticky traps as well. Many brands of sticky traps are available, but most are of a similar design—a rectangular or triangular cardboard box with bands of sticky glue inside and, in some models, a dark strip of cockroach attractant.

The best sites for traps are along the roaches' normal travel routes as they move from harborage to feeding areas. Roaches will not seek out traps located outside these travel routes. Avoid placing traps in extremely dusty areas because they will quickly lose their stickiness. Initially, put out as many traps as possible. The more traps used, the sooner the concentrations of roaches can be located. Later, you can use fewer traps for ongoing monitoring. Try to “think like a roach” as you decide where to place the traps. Your monitoring map and the following examples will help you to determine the best spots.

### Trap Locations

Keeping in mind the habitats preferred by roaches (refer to Table 6-1), place the traps in the following types of locations:

- near and under sinks and stoves
- in or near motors of refrigerators and other appliances or vending machines
- in or near electric clocks, switch plates, and conduits
- next to computer equipment (where possible)
- near leaky plumbing fixtures
- near steam pipes or hot water pipes with insulating jackets
- near drains
- in drawers and cupboards
- in closets, on their floors and upper shelves
- in false ceilings or subfloor areas
- in areas where packaged goods and equipment are delivered and stored

### Trap Placement

Once the general locations for setting out traps have been decided, it is important to place the traps along the periphery of rooms or other objects as this is where roaches travel. Traps set out in the open away from walls or other “edges” are unlikely to catch roaches. Examples of edges include the intersection of

- floors and walls

### Box 6-A.

#### Tools Used To Monitor For Cockroaches

- **Flashlight.** Use a heavy-duty, corrosion-resistant model with a bright-colored body, shatter-proof lens, and halogen bulb. A smaller halogen flashlight with a flexible neck is useful in tight, confined locations. Flashlight holders that can be attached to a belt are available.
- **Telescoping Mirror.** Use a furnace inspector's or mechanic's metal mirror with a telescoping handle and rotating head. To illuminate areas inside equipment, fixtures, etc., reflect the flashlight beam off the mirror.
- **Clipboard and Pen.** Use the clipboard to carry monitoring forms, floorplans, etc. during inspections.
- **Floorplan Maps and Building Plans.** Carry a floorplan with the major equipment and fixtures marked. In large buildings, construction drawings which show utility lines, heating/cooling ducts, shaft connections, pipe chases, etc. are very useful for locating entry points, harborages, and runways.
- **Sticky Traps.** These are used to locate harborage areas and estimate populations.
- **Flushing Agent.** A pocket-sized can of pyrethrin flushing agent is useful for spot-flushing roaches out of inaccessible areas where trapping is not sufficient.
- **Utility Tools.** A pocketknife equipped with various blades, screwdrivers, and forceps allows you to open grills, electrical boxes, and other equipment for inspections. Carry small vials and adhesive labels to collect cockroach specimens. A 10-power (10x) hand lens (small magnifying glass) will help you identify roach species. Colored adhesive labels can be used to mark hot spots, location of traps and bait stations, etc. These tools can be stored in a tool pouch worn on a belt.
- **Knee Pads and Bump Cap.** These are useful when crawling around for floor-level inspections.
- **Camera.** A Polaroid camera is useful for communicating specific conditions (e.g., unsanitary conditions, areas needing pest-proofing, etc.) in reports to decision-makers or sub-contractors not on the premises.

- floors and cabinets or other solid furnishings
- floors and appliances such as stoves, refrigerators, vending machines
- counters and walls
- hanging cabinets or shelves and walls

Place each trap so the opening is perpendicular to the wall, countertop, etc. so a roach traveling along the edge of the floor or wall can walk into the trap (see Figure 6-2).

Number and date each trap, and mark on your monitoring map. After 24 to 48 hours, count and record the number of roaches in each trap. Record the date and the number of roaches on both the trap and the monitoring form.

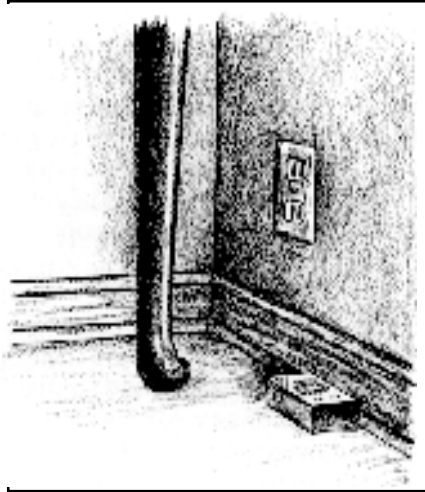

Figure 6-2

### Evaluating Trap Counts

- Traps with the highest numbers of roaches indicate a nearby harborage, and this is where management efforts should be concentrated.
- Traps with few or no roaches should be moved to other locations until all main harborage areas are pinpointed.
- When traps contain large numbers of small nymphs, this may indicate that the roach population is being stressed by such factors as scarcity of food and water, or it may indicate overcrowded harborage since nymphs generally remain within the harborage.
- Large numbers of adults in the traps can indicate a population explosion.

### On-Going Monitoring

Sometimes it is useful to continue counting the roaches in each trap every 24 to 48 hours for a week or two. This can give you a clearer picture of the population and, if it is small, the trapping may eliminate it. Where roaches rarely invade, you can check traps every 2 or 3 months (be sure to replace traps when they are full or no longer sticky). In cafeterias and other food-handling areas, check traps every month.

### Monitoring to Evaluate Treatment Efficacy

Monitoring traps can provide information on the effectiveness of management efforts. To see how well treatment efforts are working, put out fresh traps a week or so after implementing the treatment methods selected from the Management Options below, and count the roaches in the traps 24 hours later. If the roach population has dropped considerably, progress has been made. If not, greater efforts must be made to eliminate food sources and reduce harborage. In order to assess the continued success of treatments and detect any new infestations, continue to monitor after the IPM program is underway. Vigilance is important.

### Monitoring to Determine Roach Tolerance Levels

It may be impossible to eliminate cockroach infestations completely, especially in urban situations. Very old buildings may have more roach harborage than can be eliminated in any practical way, and there is always the possibility of reinfestation from roaches traveling in handbags, backpacks, clothing, used furniture and appliances, and packing materials. Because of these problems, it may be necessary to live with a certain small number of roaches. The sticky traps can help determine what this number is, since it is possible for the roach population to be low enough that the traps catch a few roaches, but no one notices any in the course of a normal day. This is considered the tolerance level and will differ depending on location, time of year, health department regulations, and availability of management resources.

Determining the number of roaches that can be tolerated will take time and experience, and will have to be done after you have reduced the cockroach population through the appropriate treatments. First you will need to ascertain the average number of roaches caught in a designated area, and then you must correlate this figure with the perceptions of the people using the area.

Set out a certain number of traps (say 10) in a certain area (perhaps the kitchen), and leave them there for a certain period of time (a week). The number of traps that you use in the area and the length of time you wait before counting must remain the same each time you make an assessment if your estimation is going to be accurate. When you make your counts, find the average number of roaches per trap by dividing the total number of roaches by the total number of traps. Record this information on

---

## Sample IPM Program for a Cockroach Infestation in a Kitchen

1. Use sticky traps to locate roach habitat and prioritize areas to be treated.
2. Knock-down the roach population by vacuuming areas where traps indicate roaches are harboring; steam-clean infested kitchen equipment and appliances if possible.
3. Initiate an education program for students, staff, custodians, and building maintenance personnel to gain cooperation for the next steps.
4. Improve sanitation and waste management procedures to reduce roach food sources.
5. Reduce roach access to water and habitat by repairing water leaks, caulking cracks, and scheduling other building repairs.
6. If the previous activities have failed to reduce roach numbers sufficiently, apply insecticidal dusts, baits, or gels in cracks and crevices in hard-to-clean areas; blow boric acid or silica aerogel into wall or ceiling voids, underneath appliances, or in other inaccessible areas where roaches harbor.
7. After the adult roach population has been reduced, apply an insect growth regulator to help prevent future roach problems.
8. Monitor weekly and fine-tune management methods as needed until the problem has been solved. Continue monitoring monthly or quarterly to insure sanitation measures are maintained and to detect any incipient buildup of roach numbers.

your monitoring form, and write on each trap the date and the number of roaches inside. Question the people using the area you are monitoring to see if they have noticed any evidence of cockroaches. Record this on your monitoring form. If the traps are still sticky, leave them out for another week and count the roaches again.

Once you have done this for a number of weeks you will begin to be able to correlate the number of roaches caught in your traps with the number that can be tolerated. Use this number as a baseline, and be aware that it may differ depending on the area and the people using the area. When the number of roaches caught is above the baseline, renewed sanitation efforts and other treatments may be justified. When the number is at or below the baseline, you don't need to do anything except continue to monitor.

## MANAGEMENT OPTIONS

### Education

Food service and custodial staff play an essential part of any successful roach management program. Provide them with information on how to maintain roach-free kitchens, dining rooms, and waste disposal areas by applying the methods described below. Teachers, students, and other staff also play a significant role in maintaining a high level of sanitation in other areas of the school, so they must be informed of their responsibilities in that regard.

### Habitat Modification

Cockroaches need food, water, and harborage to survive, and the harborage must be at the proper temperature. By modifying the environment of an infested building, you can reduce roach access to these resources. With good-quality materials and a careful job, the alterations will produce a long-term reduction in the capacity of the structure to support roaches. It is important to note that the simple act of increasing the distance between food, shelter, and water will dramatically reduce the number of roaches an environment can support. Eventually the cockroaches, especially the young, will have to expend excessive energy to get from harborage to food or water, and they will die.

### Limiting Areas for Eating

If you expect to contain and limit pest problems (ants and rodents as well as cockroaches), it is very important to designate appropriate areas for eating and to enforce these rules. The fewer designated areas, the



easier it will be to limit the pests.

### **Eliminating Cracks and Crevices**

- It is not necessary to seal all cracks. Start by caulking where roach populations are highest. If roaches remain a problem, caulk additional areas.
- Use silicon caulk or mildew-resistant caulk around sinks, toilets, and drains.
- Before beginning the sealing process, vacuum and wash the area to eliminate all egg cases, fecal material, or other debris.
- Caulk or paint closed cracks around baseboards, wall shelves, cupboards, pipes, sinks, toilets, and similar furnishings in the locations suggested by trap results.
- Repair small holes in window screens with clear caulk.
- Weather-strip around doors and windows where cockroaches may enter.
- Where gaps can't be sealed, they can be widened to make them less attractive to roaches. For example, the crack between free-standing shelving and adjacent walls can be widened by simply moving the shelving one inch away from the wall. An inch-wide gap is not attractive to roaches.

### **Eliminating Clutter**

Removing clutter from areas near prime habitat such as sinks, stoves, refrigerators, vending machines, etc. is one of the most important components of sanitation. Clutter in these areas vastly increases the available harborage that is conveniently near the cockroaches' food and water sources. For example, in kitchens, boxes should be broken down and stored in a cool or unheated area preferably near the loading dock but definitely isolated from the main kitchen.

### **Sanitation**

Sanitation eliminates food and harborage and can play a part in slowing the cockroach life cycle by scattering them as they search for new harborage (their life cycle is shorter when they are grouped together). This disruption can also help to bring more individual roaches into contact with toxic baits or insecticidal dusts (see Chemical Controls below).

Thorough daily cleaning of kitchens is essential:

- Sweep and mop the floors.
- Drain all sinks and remove any food debris.
- If children regularly receive snacks in classrooms,

### **Sample IPM Program for a Roach Population in an Office or Classroom**

1. Initiate an education program for students, staff, custodians, and building maintenance personnel to gain cooperation with the program. Since monitoring and management activities will probably involve desks, computers, lighting fixtures, and other equipment in use by staff, it is essential that they be given prior warning of work to be done and that the problem can not be solved without their cooperation.
2. Place sticky traps to locate roach habitat and prioritize areas to be treated.
3. Vacuum areas where traps indicate roaches are harboring.
4. Improve sanitation and waste management in office, snack, and lunch areas to reduce roach food sources.
5. Caulk cracks, and schedule other building repairs to reduce roach habitat.
6. If traps indicate roaches have infested computers or other electrical equipment, place insecticidal bait stations next to infested machines. Never put baits directly on or inside computers or electrical equipment. Never use aerosol insecticides around computers because of the danger of shorting out the equipment. Give office and custodial staff a map showing where bait stations have been placed and request that the stations not be moved.
7. If traps indicate that roaches have infested electrical conduit and are moving into the room through lighting switch plates, spot-treat the switch box with insecticidal bait, gel, or dust.
8. If traps indicate storage boxes containing paper files are infested with roaches, enclose file boxes in large plastic bags and fumigate with carbon dioxide.
9. If the previous activities have failed to reduce roach numbers sufficiently, apply insecticidal bait, gel, or dust in cracks and crevices, and blow insecticidal dusts into wall or ceiling voids, underneath counters, or in other inaccessible areas where roaches harbor.
10. After the adult roach population has been reduced, apply an insect growth regulator to help prevent future roach problems.
11. Continue monitoring until the roach population has been reduced to a tolerable level. Circulate a memo announcing that the roach problem has been solved and thank staff for their cooperation. Return monthly or quarterly to place and inspect traps to insure roach numbers remain within tolerable levels.
12. If monthly monitoring indicates roach populations are starting to rise, renew sanitation efforts and consider experimenting with releases of cockroach parasitoids while roach numbers are still relatively low.

---

vacuum and/or mop these floors daily.

- Periodically, give all food preparation areas an all-inclusive cleaning, focusing on areas where grease accumulates: drains, vents, deep fat fryers, ovens, and stoves. Steam-clean drains and infested appliances. Survivors driven out by the steam can be caught in traps placed nearby. Thoroughly vacuum the area with a powerful vacuum cleaner (see the section below on vacuuming).
- At the end of each day, remove from the building all garbage containing food to prevent cockroaches from feeding at night.
- Use soapy water to wash any bottles, cans, wrappings, and other items that have food residues clinging to them before storing them for recycling.
- If dishes cannot be washed right away, it is very important that they at least be rinsed to remove all food debris.
- Place garbage in sealed plastic bags before it is placed into a rodent-proof dumpster or other storage receptacle.
- Keep garbage cans and dumpsters as clean as possible to deny food to roaches as well as ants, flies, mice, and rats.

Brownbanded cockroaches can survive without free-standing water, and they can live on soap or the glue on stamps, so simple sanitation will not make as significant an impact on a brownbanded roach population as it will on German roaches.

### **Proper Food Storage**

- Food not kept in the refrigerator should be kept in containers that close tightly. Cardboard boxes and paper are not roach-proof.
- Screw-top jars are roach-proof only if the lid has a rubber seal since the roaches can follow the spiral ridges to get into the jar.
- Glass containers with rubber gaskets or plastic containers with tight-fitting, snap-top lids are also roach-proof.
- Transfer food packaged in paper to plastic or glass containers as soon as the food arrives in the building. Do not bring shipping boxes into the food preparation area. Instead, boxes should be broken down and stored away from the kitchen in a cool area until removed for recycling.
- Advise students and teachers not to leave unsealed food items in their desks or lockers. Any food kept in offices or classrooms should be stored in ant-

and roach-proof containers.

### **Installing Roach-proof Fixtures and Appliances**

Whenever food preparation areas are scheduled for remodeling, the school district can take the opportunity to install roach-proof kitchen appliances and fixtures, such as stainless-steel open shelving units. The round shape of the metal and the general openness of the design offer few hiding places for roaches. Free-standing storage units and appliances on castors enable them to be rolled away from walls to facilitate thorough cleaning.

### **Eliminating Water Sources**

The German roach survives longer on water alone than on food alone. And it survives longer without food or water if the relative humidity is higher; thus reducing the available drinking water and humidity are high priorities. Roaches find drinking water in

- sink traps
- appliance drip pans
- drain pipes
- wash basins and tubs
- toilet bowls and flush tanks
- spills
- condensation on cold-water pipes and windows
- leaky pipes and faucets
- pet dishes and aquariums
- vases
- beverage bottles
- various high-moisture foods

Much can be done to cut back this supply through repairs and barriers. Repair dripping faucets and any other leaks, and drain or ventilate moist areas. Keep kitchen surfaces dry whenever they are not in use, especially overnight.

### **Removing Vegetation**

Some roaches live primarily outdoors in the decaying vegetation of the garden and forest. Examples include the brown roach and the field cockroach. In cases where these roaches periodically come into the school, it is essential to remove decaying vegetation from foundations, leaving a clean border. Outdoor planter boxes and other structures close to the school where moisture and decayed organic material collect should also be monitored.

### **Physical Controls**

---

## Screening Vents and Windows, and Sealing Off Runways

Cockroaches can travel throughout a building and from building to building on runways such as electrical conduits, heating ducts, and especially plumbing pipes. Seal these runways with caulk, window screen, or other appropriate materials.

Roaches may also travel up the outside of the building and enter through an open window, weep hole, or ventilation duct. Screening these openings prevents roaches from using them as entry points. Screens can also be placed behind grill covers and over vents or floor drains to prevent roach entry. Use caulk around the edge of the screen to make a tight seal.

## Vacuuuming

A strong vacuum can be used to pick up roaches, including their egg cases and droppings, as well as debris that drops behind appliances or furniture and feeds the pests. If you are dealing with a huge roach population that must be knocked down immediately, a thorough vacuuming will be very effective. Once you have vacuumed up a large portion of the roach population, it will be easier to begin habitat modification.

A crevice attachment will suck roaches out of cracks, and the hose end alone can pull roaches out from under appliances, or from cupboards or upholstered furniture. If the vacuum is capable of filtering out very small particles (0.3 microns), it will greatly reduce the amount of cockroach effluvia that is blown around during cleaning. It is this effluvia that can cause allergic reactions.

Although the dust in the vacuum bag will usually clog the roaches' breathing apparatus and suffocate them, you can vacuum up a tablespoon of cornstarch to be sure they die.

## Trapping

In certain limited situations traps can also be used to reduce roach numbers. For example, the University of California used sticky traps to help control roaches in animal-rearing rooms where no insecticides were allowed (Slater et al. 1980). Traps can also capture a few roaches that might be dislodged during construction, introduced into roach-free areas on furniture or packaging, or forced into the area when an adjacent room is sprayed with an insecticide.

When traps are used to reduce populations of roaches, leave them in place until they are full. In most situations, however, trapping alone will not produce a sufficient degree of control.

## Biological Controls

One parasitoid has been used in a precedent-setting project to control the brownbanded cockroach in a large research building on the campus of the University of California at Berkeley. The roach population had become a significant problem, but because laboratory animals were being raised in this research facility, pesticides could not be used (Slater et al. 1980).

Researchers imported the egg parasitoid *Comperia merceti* from Hawaii, where it was known to be effective against the brownbanded roach. The parasitoids are so tiny—less than half the size of the roach egg capsule—that even the periodic releases of 20,000 at a time went unnoticed by the people who worked there. The fact that the building contained animal-rearing labs where food, water, and animal fecal matter were always available for roaches to feed on makes the high degree of control achieved in this project even more impressive.

Although *Comperia merceti* only attacks the brownbanded roach, another parasitoid, *Tetrastichus hagenowi*, has been found to be effective against the German, American, oriental, and smoky brown roaches.

The use of natural enemies of roaches cannot by itself be expected to solve cockroach problems. Roach control must always involve sanitation and habitat modification as described above, and, in most cases, the judicious use of chemical controls.

## Chemical Controls

If non-chemical methods alone prove insufficient to solve the problem, then integrating a pesticide into your management program may be warranted. For information on the hazards of various pesticides and on how to select an appropriate pesticide for your situation, consult Appendix G for a list of resources.

Pesticides must be used in accordance with their EPA-approved label directions. Applicators must be certified to apply pesticides and should always wear protective gear during applications. All labels and Material Safety Data Sheets (MSDS) for the pesticide products authorized for use in the IPM program should be maintained on file. Do not apply these materials when buildings are occupied, and never apply them where they might wash into the sanitary sewer or into outside storm drains.

When insecticides are needed, they should be applied as dusts in crack and crevice treatments or in bait

---

form. Broadcast spraying of insecticides will do more to scatter the cockroaches than it will to control them. This makes them more difficult to find and the pest manager must expend more time and effort baiting in the new scattered locations.

Never use aerosol insecticides around computers because of the danger of short-circuiting the equipment. Use baits near computers but do not place loose bait inside the computer or on the keyboard. When cockroaches have infested computer equipment, small quantities of dry formulations can be inserted into 2-inch lengths of plastic drinking straw and taped to the computer in inconspicuous places.

### **Resistance to Insecticides**

Insecticide resistance in cockroaches is a growing problem. Many residual poisons no longer affect cockroaches. So far, there is no documented resistance to boric acid, diatomaceous earth, or silica gel, and because of the way these insecticides work, resistance in the future is unlikely. There is no guarantee, however, that the other insecticides mentioned here will be useful forever.

There are three types of materials available for roach control: insecticidal dusts, insecticidal baits, and insect growth regulators. These materials take 5 days or longer to kill substantial numbers of roaches, and it can take weeks to suppress large populations to the point where none are seen. However, once this point has been reached, and if parallel steps are taken to reduce roach food and harborage, you can expect long-term relief from roach infestations.

### **Boric Acid**

Boric acid is one of the most valuable chemical control tools in an integrated program against roaches. It is formulated as a powder, paste, and aerosol. It acts as a stomach poison and is one of few materials that does not repel cockroaches, so they are not able to avoid it as they do other compounds. The powder and paste formulations do not vaporize into the air as do conventional sprays. Furthermore, if kept dry, it remains effective for the life of the building.

Wear a dust mask when applying boric acid powder. A very light dusting in cracks and crevices is superior to dusting large open areas. Cockroaches will avoid piles of boric acid. Boric acid is approved for crack and crevice treatment in food handling areas. It can be blown into areas of prime habitat, such as under refrigerators or into cracks in the inner recesses of

cabinets and cupboards, whether or not roaches are present.

There are a number of products on the market now that contain boric acid. In general, boric acid works better alone than when it is mixed with other insecticides. Some boric acid products contain additives which improve their effectiveness or the safety of their use, such as anti-caking agents, bitter-tasting compounds, and dyes.

Boric acid has also been formulated into baits (see discussion below for general information on baits).

### **Diatomaceous Earth and Silica Aerogel**

These are insecticidal dusts that can be used for roach control, but they are more repellent to roaches than boric acid. Diatomaceous earth is made from fossilized diatoms, and silica gel is produced essentially from sand. Both kill insects by desiccation; they absorb the wax and oil from the insect's outer covering, which causes dehydration and death. Although these materials are not poisonous to humans directly, the fine dust travels freely through the air and can be irritating to the eyes and lungs; therefore, use a dust mask and goggles during application.

Diatomaceous earth and silica aerogel are especially useful in wall voids and similar closed spaces. During construction and remodeling these dusts can be blown into such spaces, and in finished buildings they can be applied by drilling tiny holes in the walls. These dusts are also useful in crack and crevice treatments.

Some products combine diatomaceous earth or silica gel with pyrethrins. The pyrethrins provide a quick knock-down of the cockroaches, and the dusts provide the long-term control.

### **Cockroach Baits**

In general, baits help to reduce the amount of pesticide used against a pest because the pest is attracted to discreet locations where it comes into contact with the poison; the pesticide doesn't need to be spread around all over the environment. Baits work best where sanitation and physical modifications are also employed so that the bait is not competing with freely available roach food.

### **Bait Placement Tips**

According to Dr. Austin M. Frishman (Frishman 1994), there are a number of tricks to placing bait properly.

- Large blobs of baits in a few locations do not work well because German cockroaches don't easily find

---

food that is any distance from their harborage. Put out small amounts of bait in many locations.

- Put bait near harborage and between harborage and food. Review the Monitoring section for examples of roach harborage, and use the information collected from your monitoring traps.
- Once you have pinpointed harborage areas, place the baits along edges or in places where roaches are most likely to travel or congregate. If the bait is between the harborage and the food but not in a place where roaches are likely to run into it, the baiting program will fail.
- Sometimes an inch one way or the other can make all the difference in bait placement. If air currents are moving the bait odors away from the cockroach harborage, they will never find the bait.
- Make sure that the surface of the bait will not get covered by excessive grease, flour, or dust. In areas where this might be a problem, such as near french fry preparation, the bait must be protected.
- Harsh environments pose various problems in a baiting program. In very warm areas baits can melt and run, in cold environments the cockroaches don't move far and may miss the bait, and in very warm and wet environments the baits may grow mold that renders them unattractive to roaches. Boric acid baits hold up better in the last situation because boric acid naturally inhibits mold growth.
- Check baits frequently to make sure that someone has not inadvertently painted over them or accidentally knocked them off while cleaning, etc.
- If new cockroaches are moving in so fast that it appears that the baits are failing, you may need to elicit more help from the school staff in preventing contaminated goods from coming into areas of prime habitat.

As Dr. Frishman notes, "Keep in mind that you are trying to control living organisms. It is not a simple mathematical formula that works every time. You sometimes have to adjust what you did to get the baits to do the job. I call it 'tweaking the baits to perfection.'"

#### **Active Ingredients Used in Baits**

Abamectin—an extract from the naturally occurring soil microorganism *Streptomyces avermitilis*.

- available as a dust, spray, or gel

- can be applied only by a commercial pest control operator
- works both as a lethal internal toxicant and as a contact insecticide when roaches groom themselves and ingest the bait
- takes a week or longer to kill 70 to 90% of the roaches, may take 12 weeks to achieve 100% kill
- should be used in cracks and crevices and in other inaccessible places near harborage
- not registered for use in food preparation or food handling areas.

Boric Acid—a general enzyme-inhibitor.

- available as a paste either in bulk or in a cartridge for bait gun application.
- available as a weather-resistant, granular bait
- also available as a "fine granular" bait that can be used in a bulb duster for interior crack and crevice treatment (the advantage of a granular bait is that roaches are exposed by contact as well as by ingestion)
- use dust mask and goggles during application

Hydramethylnon—a slow-acting stomach poison that must be ingested to be effective.

- Roaches die within 2 to 8 days after feeding on the bait.
- Available in a plastic disk as well as a gel.
- Disks come with a double-sided tape so they can be glued to various surfaces out of view. The tape also facilitates placement of the bait stations on the undersides of drawers, on walls.
- Two to 3 discs per 100 square feet of horizontal surface area are recommended. This may not be enough bait stations when roach numbers are high, and the bait will be used up quickly leaving the empty stations as excellent roach harborage.
- If you see roaches inside stations, they are probably using the discs as harborage after having eaten all the bait. Put these discs into a plastic bag, seal, and discard.
- The bait may last for several months if roach numbers are low to moderate, but the bait stations should be checked 4 to 6 weeks after installation.
- Although hydramethylnon is less repellent when it is used in a bait station, the gel formulation is useful in situations where it is difficult to place a bait station.

---

Inspect bait locations each week reapply if bait has been depleted. Do not place bait gels on surfaces that will be washed because the bait will be washed away. Hydramethylnon gels are not registered for use in food preparation or storage areas.

*Metarhizium anisopliae*—a fungus that has been tested rather thoroughly over the last hundred years. Because it cannot grow at temperatures greater than 95°F, it does not infect humans or other mammals.

- Bait stations do not contain a food attractant; roaches are attracted to the water in the formulation.
- Roaches are infected when they touch the fungus as they enter the station.
- Individuals carry the pathogen back to their harborage to infect other roaches.
- It takes 4 weeks or longer to kill 80% of the roaches, and may take 5 or more weeks to achieve 100% kill.
- Do not place bait stations near radiators or other sources of heat as heat will destroy the fungus.
- Direct exposure to sunlight might also kill the fungus.

### **Insect Growth Regulators (IGRs)**

IGRs, such as hydroprene, are synthetic versions of the juvenile hormones insects produce to regulate development from their immature to adult stages. Because many of the worst cockroach infestations occur in settings where migration from one infested area to another takes place, new adults can continue to move into areas where IGRs have been applied and the new roaches will not be affected. As a result, use of IGRs makes sense only if they are combined with other tactics such as roach exclusion, reduction of access to water, food and harborage, and application of an adulticide such as boric acid.

- IGRs do not kill insects directly. Their most important effect is to cause immature roaches to become sterile adults and eventually die without reproducing. But those roaches that are already adults before they come into contact with an IGR will keep on reproducing.
- IGRs are best applied after heavy roach infestations have been reduced to low levels and every effort has been made to eliminate harborage or opportunities for roaches to migrate in from other areas. When IGRs are used this way, the small number of immature roaches that survived suppression efforts

(perhaps because they were still inside egg capsules when the cleanup took place) will encounter the IGR and fail to mature and reproduce. Adults that survived the cleanup may produce young before dying, but their young will be sterilized by the IGR. Theoretically, the IGR will eventually eliminate the remnant cockroach population.

- For brownbanded control, the IGR should be sprayed in prime egg-laying habitat (rough, dark places) so that when eggs hatch the nymphs will be exposed immediately to the material.
- To monitor the effectiveness of IGR use, place sticky traps in areas where roaches are known to travel. Immature roaches that have been exposed to an IGR become adults that are darker in color and somewhat distorted in appearance (they have twisted wings). When you begin finding these roaches in the traps, you know the reproduction rate is being lowered.

### **Carbon Dioxide Fumigation**

Carbon dioxide gas (CO<sub>2</sub>) can be used to kill cockroaches when they have infested cartons of papers, clothes, or other stored materials.

- Loosely fill a heavy-duty plastic garbage bag with the infested items, and insert the end of a vacuum hose into the bag to suck out as much air as possible.
- Tightly seal the bag using duct tape to reinforce all seams.
- Finally, insert a hose from a CO<sub>2</sub> canister into a small opening cut in the top side of the bag. Fill the bag with undiluted CO<sub>2</sub> from the canister, remove the hose, and seal the hole with duct tape. Leave the bag sealed overnight.
- When the bag is opened, roaches will either be dead or extremely sluggish and will die a short time later without further treatment.

### **BIBLIOGRAPHY**

- Bio-Integral Resource Center (BIRC). 1996. 1997 directory of least-toxic pest control products. *The IPM Practitioner* 18(11/12):1-39.
- Cochran, D.G. 1994. How resistant are they? *Pest Management* 13(6):14-16.
- Daar, S. 1987. Boric acid: new formulations and application equipment. *The IPM Practitioner* 9(6/7):3-4.
- Frishman, A. 1994. 15 ways to misuse German cockroach baits.

- 
- Pest Control 22(4):23,67.
- Mallis, A. 1982. Handbook of Pest Control. Franzak and Foster, Cleveland, OH. 1,101 pp.
- Moore, W.S. and T.A. Granovsky. 1983. Laboratory comparisons of sticky traps to detect and control five species of cockroaches (Orthoptera: Blattidae and Blattellidae). *Journal of Economic Entomology* 76(4):845-849.
- Olkowski, W., S. Daar, and H. Olkowski. 1991. *Common-Sense Pest Control: least-toxic solutions for your home, garden, pets and community*. Taunton Press. Newtown, CT. 715 pp.
- Olkowski, W., H. Olkowski, and S. Daar. 1983. *The German Cockroach*. Bio-Integral Resource Center, Berkeley, CA. 22 pp.
- Olkowski, W., H. Olkowski, and T. Javits. 1979. *The Integral Urban House*. Sierra Club Books, San Francisco. 494 pp.
- Owens, J.M. and G.W. Bennett. 1983. Comparative study of German cockroach (Dictyoptera: Blattellidae) population sampling techniques. *Environmental Entomology* 12:1040-1046.
- Quarles, W. 1995. Least-toxic baits for roaches. *Common Sense Pest Control Quarterly* 10(1):5-12.
- Slater, A., M. Hurlbert, and R. Lewis. 1980. Biological control of brown-banded cockroaches. *California Agriculture* 34(8/9):16-18.
- Snetsinger, R. 1989. A paper on the use of diatomaceous earth (as the product Shellshock®) for cockroach control, delivered at the 1989 annual meeting of the Entomological Society of America. *The IPM Practitioner* 12(2):6.

---

## CHAPTER 7

# IPM FOR CLOTHES MOTHS AND CARPET BEETLES IN SCHOOLS

## INTRODUCTION

The insects discussed in this chapter, clothes moths and carpet beetles, are sometimes referred to as fabric pests. They can digest keratin, the “hard” protein of which hair, horns, nails, claws, hoofs, feathers, and reptile scales are formed. These insects can also attack a wide variety of other natural materials and even some synthetic ones.

## IDENTIFICATION AND BIOLOGY

### Clothes Moths

The most common fabric-attacking moths are the webbing and the casemaking clothes moths. The webbing clothes moth (*Tineola bisselliella*) is common throughout the United States, while the casemaking moth (*Tinea pellionella*) is most common in the southern states. The adults of both species are about 1/4 inch long, and have a wingspan of 1/2 to 3/4 inch. The webbing clothes moth is golden buff or yellowish gray with a satiny sheen; the hairs on its head are upright and reddish. The casemaking clothes moth is similar in size and shape, but has a browner hue and three indistinct dark spots on the wings with lighter-colored hairs on the head.

Adult moths of both species avoid light and attempt to hide when disturbed, which helps distinguish these moths from others (see also Table 7-1). They are occasionally seen flying in subdued light. Males fly more often than females, but both may fly considerable distances and can move from building to building in favorable weather. Adults can be seen flying at any time of year, but they are more common during the summer months.

The life cycles of the two moths are similar. Adult females lay an average of 40 to 50 eggs. Incubation takes from 4 days to 3 weeks or sometimes longer. If conditions are good—meaning abundant food, temperatures around 75°F, and at least 75% relative humidity—a new generation can be produced in a month. It takes over a year when conditions are less favorable, and periods up to 4 years have been recorded in the laboratory. The larval and pupal stages combined may take from 45 days to more than a year to complete. At ordinary household temperatures, adult moths live from 2 to 4 weeks. The adults do not feed on fabrics.

In heated buildings, female webbing clothes moths can mate and lay eggs any time during the year. The casemaking clothes moth generally produces one generation each year in the northern U.S. and two generations in the south. This species particularly likes feathers, and may reduce stored garments, quilts, or down pillows to masses of frass (insect fecal material). The casemaking clothes moth also attacks other food and fiber, such as cayenne pepper, horseradish, ginger, black mustard seed, and hemp.



Case-making Clothes Moth



Carpet Beetle

The larvae of both moths are also similar (pearly-white, naked bodies and dark heads) but the casemaking moth larva spins a characteristic silken tube under which it feeds. These tubes can include parts of the fabric. Larvae of both species range from 1/4 to 1/2 inch long when fully grown. Their fecal matter is often the same color as the material they consume.

### Carpet and Hide Beetles

Adult beetles are small and have short, clubbed antennae, but are otherwise varied in appearance (see Table 7-2). Their bodies are covered with small scales or hairs, which are visible with a magnifying glass. Larvae are brownish, and 1/8 to 1/2 inch long, and characteristically hairy or bristly.

As with clothes moths, the larval stage is the most damaging. Females lay eggs throughout the year and the eggs hatch after less than two weeks. The larvae feed for varying periods, depending upon the species and the environmental conditions. When ready to pupate, the larvae may burrow farther into the food or wander and burrow elsewhere. They may also pupate within their last larval skin or burrow into wood if no other location is found. Beetle larvae do not construct webs, but their shed skins and fecal pellets make it obvious where larvae have been feeding. The cast skins look so much like live larvae that under casual



**Table 7-1. Distinguish among Common Clothes Moths and Common Grain Moths**

Species	Distinguishing Characteristics
Webbing clothes moth ( <i>Tineola bisselliella</i> )	<ul style="list-style-type: none"> <li>• wingspan 1/2 inch, resting length 1/4 inch</li> <li>• wings without spots</li> <li>• body covered with shiny golden scales</li> <li>• usually with reddish hairs on head</li> <li>• adults fly in dark areas</li> <li>• cosmopolitan</li> </ul>
Casemaking clothes moth ( <i>Tinea pellionella</i> )	<ul style="list-style-type: none"> <li>• same size as webbing clothes moth but less common</li> <li>• more brownish than webbing clothes moth</li> <li>• often with three indistinct dark spots on the wings (on older they may have rubbed off)</li> <li>• larvae always in case</li> <li>• adults fly in dark areas</li> <li>• not common in northern states</li> </ul>
Mediterranean flour moth ( <i>Anagasta [Ephesia] kuehniella</i> )	<ul style="list-style-type: none"> <li>• wingspan 4/5 inch</li> <li>• hind wings dirty white, forewings pale gray with transverse wavy bars</li> <li>• at rest forebody distinctly raised</li> <li>• cosmopolitan</li> </ul>
Indianmeal moth ( <i>Plodia interpunctella</i> )	<ul style="list-style-type: none"> <li>• wingspan 5/8 inch, resting length 1/2 inch</li> <li>• broad grayish band across bronzy wings</li> <li>• favors dried fruit but will feed on many other stored products</li> <li>• cosmopolitan</li> </ul>
Angoumois grain moth ( <i>Sitotroga cerealella</i> )	<ul style="list-style-type: none"> <li>• same size as webbing clothes moth</li> <li>• pale yellow forewings and gray pointed hind wings</li> <li>• cosmopolitan</li> </ul>

Adapted from Olkowski, et al. 1991

inspection there may seem to be a far larger infestation than is actually present.

Some adult carpet beetle species feed on pollen and nectar; thus, they may be introduced into the school on cut flowers. They are sometimes mistaken for lady beetles, because some species are similarly round in shape.

## DAMAGE

### Clothes Moths

Adult clothes moths do not feed; only their larvae cause damage. Clothes moth larvae feed on pollen, hair, feathers, wool, fur, dead insects, and dried animal remains. Feeding holes are scattered over the material and are usually small. Clothing, carpets, furs, blankets, upholstery, piano felts, and a myriad of other items are subject to their attack. They will also feed on wool mixed with synthetic fibers. Only the wool is digested while the other fibers pass through the insect's gut.

Clothes moths are attracted to stains on fabrics from food and human sweat and urine. It is mostly goods in storage that are damaged because the larvae are so fragile that they cannot survive in clothing worn regularly.

### Carpet and Hide Beetles

Carpet beetle holes are usually concentrated in a few areas and can be quite large, in contrast to clothes moth holes. As a group, these beetles cause far more damage than clothes moths, since the range of substances they consume is much wider. Carpet beetles damage materials made from wool such as sweaters, uniforms, felt, wool

yarn, etc. They can also destroy insect collections, furniture, and carpets. Hide beetles feed on animal carcasses and hides, and also damage furnishings, carpets, and fabrics. Some species also infest stored, dried foods such as cereal. (Table 7-3 provides more detailed information on the food preferences of both hide and carpet beetles.)

### DETECTION AND MONITORING

Look for holes in fabric, for larvae, moth cocoons, cast skins of beetle larvae, or insect excreta in stored materials, or for small moths fluttering about in dimly lit areas.

**Table 7-2. Important Carpet or Hide Beetles (sometimes called Dermestids)**

Common Name(s)	Scientific Name	Description of Adults
Furniture carpet beetle	<i>Anthrenus flavipes</i> (= <i>A. vorax</i> )	<ul style="list-style-type: none"> <li>• 1/10 inch to 1/5 inch long</li> <li>• definite cleft at rear</li> <li>• mottled with black, white, and yellow scales</li> </ul>
Common carpet beetle, buffalo bug, buffalo moth	<i>A. scrophulariae</i>	<ul style="list-style-type: none"> <li>• 1/8 inch long</li> <li>• blackish with varied pattern of white and orange scales on back</li> <li>• scalloped band of orange-red scales down middle back</li> </ul>
Varied carpet beetle	<i>A. verbasci</i>	<ul style="list-style-type: none"> <li>• 1/8 inch long</li> <li>• mottled with white, brownish and yellowish scales</li> </ul>
Black carpet beetle	<i>Attagenus megatoma</i>	<ul style="list-style-type: none"> <li>• 1/10 inch to 1/5 inch long, oval</li> <li>• shiny black and dark brown with brownish legs</li> </ul>
Black larder beetle, incinerator beetle	<i>Dermestes ater</i> (= <i>D. cadaverinus</i> )	<ul style="list-style-type: none"> <li>• 3/10 inch to 2/5 inch long</li> <li>• black with yellowish gray hairs</li> <li>• black rounded and hook-shaped spots on underside of abdomen</li> </ul>
Larder beetle	<i>D. lardarius</i>	<ul style="list-style-type: none"> <li>• 3/10 inch to 2/5 inch long</li> <li>• dark brown with pale grayish yellow hair</li> <li>• yellow band at base of wing covers with about six black spots</li> </ul>
Hide beetle, leather beetle	<i>D. maculatus</i> (= <i>D. vulpinus</i> )	<ul style="list-style-type: none"> <li>• 1/5 inch to 2/5 inch long</li> <li>• black with white hairs on sides and undersides</li> <li>• apex of each wing cover comes to a fine point</li> </ul>
Warehouse beetle	<i>Trogoderma variabile</i>	<ul style="list-style-type: none"> <li>• 1/8 inch long</li> <li>• brownish black</li> </ul>

Adapted from Olkowski, et al. 1991

**Table 7-3. Some Food Sources for Carpet and Hide Beetles**

Beetle	Food Sources
Furniture carpet beetle ( <i>Anthrenus flavipes</i> )	horse-hair filled furniture, wool, hair, fur, feathers, bristles, horn shell, silk, animal excreta, stained linen, cotton, rayon, jute, softwood bags, dried silkworm pupae and cocoons, dead mice, dead insects, dried cheese, old grain, casein, dried blood, and the glue of book bindings
Common carpet beetle (buffalo bug, buffalo moth) ( <i>A. scrophulariae</i> )	carpets, fabrics, woolens, feathers, leather, furs, hairbrush bristles, mounted museum specimens; found in a chipmunk nest in the California mountains; adults found on <i>Spiraea</i> , <i>Ceanothus</i> (a chaparral shrub), wild buckwheat daisy, and wild aster flowers; they enter homes on cut flowers
Varied carpet beetle ( <i>A. verbasci</i> )	nests of bees, wasps, and spiders; carpets, woolen goods, skins, furs, skins of animals, leather book bindings, feathers, horns, whalebone, hair, silk manure, dried silkworm pupae, rye meal, cacao, corn, red pepper, and insects in collections
Black carpet beetle ( <i>Attagenus megatoma</i> )	feathers, dead birds, birds' nests, bird manure, dry horse and cow carcasses, seeds, grains, cereals, woolen rugs, clothing, carpeting, felts, furs, silk velvet, silk, hair-filled mattresses, upholstered furniture, wool-filled house insulation with sheep wool or cattle hair, meat, insect meal, kid milk powders, casein, books, cayenne pepper, dried pupae of silkworm food, spilled flours, and pollen (for adults, particularly <i>Spiraea</i> )
Black larder beetle, incinerator beetle ( <i>Dermestes ater</i> )	rodent cadavers in walls of building; partially burned food and other kitchen wastes in incinerators; pet foods.
Larder beetle ( <i>D. lardarius</i> )	stored ham, bacon, meats, cheese, dried museum specimens, stored tobacco, dried fish, dog biscuits; can tunnel slightly in wood; can penetrate lead but not zinc or aluminum; pest of silkworm cultures; reported to attack hatched chickens and ducklings
Hide beetle, leather beetle ( <i>D. maculatus</i> )	prefers hides and skins; used to clean carcasses; known to survive on small amounts of meat and dried cheese, but cannot live on fat alone; larvae can tunnel short distances into wood
Warehouse beetle ( <i>Trogoderma variabile</i> )	prefers barley, wheat, animal feeds, grains, and pollen; also found in stored dead animals, cereals, candy, cocoa, cookies, corn, corn meal, dog food and "burgers"), fish meal, flour, dead insects, milk powder, nut meats, peas, potato chips, noodles, spaghetti, and dried spices

From Mallis 1982

The fluttering flight itself is quite distinctive, and may be enough to distinguish them from food-infesting moths, which have a steadier flight.

Unlike moth larvae, carpet beetle larvae may be found wandering far from their food, particularly to pupate, so they are sometimes encountered on materials they do not actually eat. Also, unlike clothes moths, adult carpet beetles do not shun light and may be found crawling on windows. This is often the first place they are noticed.

These beetles and moths are easy to catch: cover the insect with a jar and slowly slide a card under the open

end. Seal the jar and place it in the freezer overnight. The dead insect can be examined with a magnifying glass or taken to a professional for identification.

An inspection should include the following locations:

- around carpets or furniture covered or filled with susceptible materials; infestations may be under the slipcovers, where it is dark and quiet, or in the pads under the carpet
- around accumulations of lint and other organic debris, particularly under and behind furniture that is rarely moved, in wall and floor cracks, in cracks behind

**Table 7-3. Some Food Sources for Carpet and Hide Beetles**

Beetle	Food Sources
Furniture carpet beetle ( <i>Anthrenus flavipes</i> )	horse-hair filled furniture, wool, hair, fur, feathers, bristles, horn, tortoise shell, silk, animal excreta, stained linen, cotton, rayon, jute, softwood, leather, bags, dried silkworm pupae and cocoons, dead mice, dead insects, dried cheese, old grain, casein, dried blood, and the glue of book bindings
Common carpet beetle (buffalo bug, buffalo moth) ( <i>A. scrophulariae</i> )	carpets, fabrics, woolens, feathers, leather, furs, hairbrush bristles, silks, mounted museum specimens; found in a chipmunk nest in the California mountains; adults found on <i>Spiraea</i> , <i>Ceanothus</i> (a chaparral shrub), wild buckwheat daisy, and wild aster flowers; they enter homes on cut flowers
Varied carpet beetle ( <i>A. verbasci</i> )	nests of bees, wasps, and spiders; carpets, woolen goods, skins, furs, stuffed animals, leather book bindings, feathers, horns, whalebone, hair, silk, fish manure, dried silkworm pupae, rye meal, cacao, corn, red pepper, and dead insects in collections
Black carpet beetle ( <i>Attagenus megatoma</i> )	feathers, dead birds, birds' nests, bird manure, dry horse and cow carcasses, seeds, grains, cereals, woolen rugs, clothing, carpeting, felts, furs, skins, yarn, velvet, silk, hair-filled mattresses, upholstered furniture, wool-filled blankets, house insulation with sheep wool or cattle hair, meat, insect meal, kid leather, milk powders, casein, books, cayenne pepper, dried pupae of silkworms, pet food, spilled flours, and pollen (for adults, particularly of <i>Spiraea</i> )
Black larder beetle, incinerator beetle ( <i>Dermestes ater</i> )	mouse cadavers in walls of building; partially burned food and other kitchen wastes in incinerators; pet foods.
Larder beetle ( <i>D. lardarius</i> )	stored ham, bacon, meats, cheese, dried museum specimens, stored tobacco, dried fish, dog biscuits; can tunnel slightly in wood; can penetrate lead and tin but not zinc or aluminum; pest of silkworm cultures; reported to attack newly hatched chickens and ducklings
Hide beetle, leather beetle ( <i>D. maculatus</i> )	prefers hides and skins; used to clean carcasses; known to survive on smoked meat and dried cheese, but cannot live on fat alone; larvae can tunnel short distances into wood
Warehouse beetle ( <i>Trogoderma variabile</i> )	prefers barley, wheat, animal feeds, grains, and pollen; also found in seeds, dead animals, cereals, candy, cocoa, cookies, corn, corn meal, dog food (dried and "burgers"), fish meal, flour, dead insects, milk powder, nut meats, dried peas, potato chips, noodles, spaghetti, and dried spices

---

filing cabinets, shelves, or other built-in items that may not be flush with the wall, behind baseboards, moldings and window trim, and in cold air and heater ducts

- around stored animal specimens, feathers, garments, blankets, or other items made of susceptible materials
- around bags or boxes of dried milk, fish or meat meal, dog food, etc; note that carpet beetles can bore through cardboard and paper packaging

If the infestation does not appear large enough to account for the number of pests found, or if cleaning up the infestation does not seem to diminish their number, then a further search should focus on less obvious sources:

- bird, wasp, bee, squirrel, or other animal nests on, or very close to, the walls of the building
- animal carcasses or trophies, insect collections, or leather or horn goods
- cut flowers, or blooming bushes near open, unscreened windows or doorways
- incompletely incinerated garbage

In some circumstances, sticky traps placed in areas where activity is suspected may be useful for monitoring. Hang them where you suspect you might have a problem and check them daily. Sticky traps that contain an attractant called a “sex pheromone” are available for the webbing clothes moth. A sex pheromone is a chemical signal that female moths give off to attract males. If you have a small infestation in a limited area, you may also be able to solve a webbing clothes moth problem using only these traps.

## MANAGEMENT OPTIONS

There is rarely a need to use an insecticide to control clothes moths or carpet beetles. The following physical controls should be adequate.

### Physical Controls

#### Storage in Tight Containers

If clean materials are placed into tightly sealed containers, they will be safe from infestation. The problem with closets and similar storage areas is that they are almost impossible to seal because newly hatched larvae are so small they can crawl through any gap larger than 0.0004 inch.

Entomologist Roy Bry (USDA Stored Product Insects Laboratory in Savannah, GA) suggests wrapping clean, susceptible materials in heavy brown paper and

carefully sealing the package with heavy-duty tape. As long as the package is not punctured or torn, the contents should be safe from attack for years. Clean materials could also be stored in heavy-duty Ziploc® plastic bags or heavy-duty plastic garbage bags (2.7 mils or thicker, or a double bag) sealed with tape (Bry et al. 1972).

All grains, cereals and other similar susceptible substances should be stored in tight-fitting containers to deny beetles access. Containers can be placed in the freezer for a few days to help reduce the possibility of an infestation developing.

### Cedar Products

Cedar chests have long been thought to protect against fabric pests, but it has been known for many years that although cedar oil can kill very young clothes moth larvae, the oil does not affect eggs, pupae, adults, or larger larvae, and that cedar lumber loses its oil in only a few years (Back and Rabek 1923, Laudani and Clark 1954, Laudani 1957). Commercial repellents made from cedar, cedar oil, or herbs cannot be counted on to give adequate control to protect goods either (Abbott and Billings 1935).

### Vacuuming

Accumulations of lint, human and animal hair, and other organic debris in cracks and crevices of floors, baseboards, closets, and shelves provide food for fabric pests. These areas should be cleaned thoroughly and regularly to prevent infestations. It is particularly important to clean under furniture that is rarely moved (e.g., desks, bookcases, cabinets, etc.); in closets where fabric items, furs, and feather-filled materials are stored; and inside and behind heaters, vents, and ducts.

### Caulking

Caulking or otherwise repairing cracks and crevices where lint and hair can accumulate will reduce the number of fabric pests that are able to live in the environment. Areas of particular concern are the spaces inside cabinets where shelves do not meet the wall and similar spaces in drawers holding susceptible materials. These same habitats are likely to be inviting to cockroaches.

### Cleaning and Airing Fabrics, Carpets, and Furniture

Since many fabric pests are attracted to the food, beverage, perspiration, and urine stains in woolens and other materials, garments should be cleaned thoroughly before

Table 7-4. Length of Time Various Stages of the Clothes Moth Must Be Exposed to Heat to Produce 100% Mortality<sup>a,b</sup>

	95°F	97°F	99°F	100°F	102°F	104°F	106°F
egg			2 days		1 day		4 hours
larva			7 days	18 hours		3 hours	3 hours
pupa				1 day		3 hours	
adult	6 days	3 days	3 days	1 day	1 day	4 hours	

<sup>a</sup> Tests conducted at 70% relative humidity.

<sup>b</sup> Adapted from Rawle 1951

being stored. If materials cannot be stored in moth- and beetle-proof packages or containers, they should be shaken, brushed, and aired regularly. This will kill delicate moth larvae and cocoons. Vigorous brushing can remove moth and beetle eggs. Susceptible furniture and carpets that cannot be washed can be steam cleaned.

Fabrics and other items badly damaged by beetles should be thrown away in sealed plastic bags or burned. If the item is salvageable, submerge it in hot soapy water (at least 120°F) for 2 to 4 hours to kill the larvae and eggs.

### Exposure to Heat

Heat can be used to kill all stages of the clothes moth that might be hiding in cracks and crevices of an infested closet or storage space (see Table 7-4). Remove all materials from the space and place a heater in the center of the floor. Turn the heater to its hottest setting and monitor the temperature with a thermometer that registers temperatures over 120°F. Keep the temperature at 120°F for 4 hours to kill the insects (Ebeling 1975).

### Exposure to Cold

Sudden changes in temperature from cold to warm can cause clothes moth mortality. In the Handbook of Pest Control, Arnold Mallis (1982) suggests that “if articles infested with clothes moths were refrigerated at 18°F for several days, then suddenly exposed for a short time to 50°F, and then returned to 18°F, and finally held permanently at about 40°F, all moth life in them would be killed....During the winter if furniture is placed outdoors at 0°F for several hours, it often results in good control.” Smaller items should be bagged and moved in and out of bin-type freezers that are normally kept at 0°F. Infested items can be placed in tightly closed plastic bags in a freezer for 2 to 3 days, since few insects can withstand this temperature. After that, they can be moved for long-

term storage to closets or chests at room temperature.

### Microwave Radiation

In laboratory studies, eggs, larvae, and adults of webbing clothes moths on wool were killed after 4 minutes at 2,450 MHz in a Sharp™ carousel microwave oven (Reagan et al. 1980). Although these tests indicate that microwave radiation is useful in destroying clothes moths, further work is necessary before a treatment procedure can be fashioned from this preliminary work. Additional studies should help determine the optimum depth of the material, since thick layers may shield the moths. Note that any clothing with metal buttons, zippers, or decorations should not be microwaved.

### Removal of Animal Nests

Clothes moths and carpet beetles can sometimes move into buildings from the abandoned nests of birds, rodent s, bats, bees, and wasps, as well as from the carcasses of dead animals. Remove nests in the eaves, in the walls, or close to the walls of the school. Problems with birds’ nests usually occur after the nestlings have left. Nests should be removed before the cold weather sets in and the beetles begin searching for sheltered hibernation spots. If there is a problem with rats and mice, these should be trapped rather than poisoned. If poisoned rodents die in inaccessible places, their carcasses can become food sources for fabric pests and flies. (See Chapter 12 for management of mice and rats.)

## BIBLIOGRAPHY

- Abbott, W.S. and S.C. Billings. 1935. Further work showing that paradichlorobenzene, naphthalene and cedar oils are ineffective as repellents against clothes moths. *Journal of Economic Entomology* 28:493-495.
- Back, E.A., and F. Rabek. 1923. Red cedar chests as protection

- 
- against moth damage. USDA Technical Bulletin 1051.
- Baerg, W.J. and L.O. Warrent. 1954. Biology and control of the webbing clothes moth. Arkansas Agricultural Experiment Station Bulletin 544. 19 pp.
- Bio-Integral Resource Center (BIRC). 1996. 1997 directory of least-toxic pest control products. *IPM Practitioner* 18(11/12):1-39.
- Bry, R.E., L.L. McDonald and J.H. Lang. 1972. Protecting stored woolens against fabric-insect damage: a long-term nonchemical method. *Journal of Economic Entomology* 65(6):1735-1736.
- Ebeling, W. 1975. *Urban Entomology*. University of California, Los Angeles. Division of Agricultural Sciences. 695 pp.
- Laudani, H. 1957. PCOs should treat cedar chests and closets for moths. *Pest Control* 25(10):39-40, 98.
- Laudani, H., and P.H. Clark. 1954. The effects of red, white, and South American cedar chests on the various stages of the webbing clothes moth and the black carpet beetle. *Journal of Economic Entomology* 47:1107-11.
- Mallis, A. 1982. *Handbook of Pest Control*. Franzak and Foster, Cleveland. 1,101 pp.
- Olkowski, W., S. Daar, and H. Olkowski. 1991. *Common-Sense Pest Control: Least-toxic solutions for your home, garden, pets and community*. Taunton Press, Newtown, CT. 715 pp.
- Rawle, S.G. 1951. The effect of high temperatures on the common clothes moth, *Tineola bisselliella*. *Bulletin of Entomological Research* 42(1):29-40.
- Reagan, B.M., Chiang-cheng, Jaw-Hu, and N.J. Streit. 1980. Effects of microwave radiation on the webbing clothes moth, *Tineola bisselliella* and textiles. *Journal of Food Protection* 43(8):658-663.
- Wilson, H.F. 1940. Lures and traps to control clothes moths and carpet beetles. *Journal of Economic Entomology* 33:651-653.





# CHAPTER 8

## IPM FOR FLEAS IN SCHOOLS

### INTRODUCTION

Fleas can be a problem in all parts of the country except in very dry areas. The most common species in school buildings is the cat flea (*Ctenocephalides felis*). This flea feeds on cats, dogs, and humans, as well as rodents, chickens, opossums, raccoons, and other animals. The dog flea (*C. canis*) and the human flea (*Pulex irritans*) are less commonly encountered.

### IDENTIFICATION AND BIOLOGY

Fleas are small, wingless insects. They pass through four developmental stages: egg, larva, pupa, and adult (Figure 8-1). The adult body is oval and compressed on the sides, allowing the insect to glide through the narrow spaces between the hairs of its host. Young adults that haven't had their first blood meal are quite small and black in color; after feeding they expand and appear lighter brown. The hairy, worm-like, white larvae, which are 1/16 to 3/16 inches long, have a distinct brown head.

Under the best conditions, a female flea can lay about 25 eggs a day for at least three weeks. She lays eggs either on the host or in its bed or nest. Eggs laid on the host fall off and accumulate in floor cracks, rugs and carpets, dust, and damp soil.

Eggs hatch in 2 to 12 days. Optimal conditions for egg hatching and flea development are temperatures between 65 and 80°F with a relative humidity of 70% or more.

Dry conditions and temperatures over 95°F are fatal to larvae because they lose excessive moisture.

The larvae develop over 8 to 21 days in the cracks and crevices where the eggs have fallen. In unfavorable conditions, they may develop more slowly, taking up to 200 days. The larvae feed on dried blood excreted

by adult fleas.

When conditions are favorable, the pupal stage lasts 1 to 2 weeks, but when it is cool and moist and no host is present, this stage can last nearly a year. Adult fleas emerge from the pupal case in response to the warmth, vibrations, and carbon dioxide coming from an animal or human. This ability of flea pupae to wait until a host arrives can result in a sudden increase of adult fleas when they emerge simultaneously from many accumulated flea pupae.

As soon as the adult fleas emerge from the pupal case, they look for a host for their first blood meal. Adults can live 1 to 2 months without a meal and can survive 7 or 8 months with one.

These variations in flea development time account for the sudden appearance of large numbers of adult fleas in "flea season," usually in the late summer and early fall. The flea population has been building up all year long in the form of eggs, larvae, and pupae, but rapid development into biting adults cannot be completed until the temperature and humidity are right and a host appears.

### DAMAGE

Flea bites cause irritation, but also serious allergies in animals and humans. Other more serious and less common problems are associated with the cat flea. Cat fleas can carry or transmit various organisms, such as *Yersinia pestis*, which causes bubonic plague; *Rickettsia typhi*, which causes murine typhus; and *Dipylidium caninum*, the double-pored dog tapeworm, which can live in dogs, cats, or humans.

### DETECTION AND MONITORING

Fleas can be a problem in schools even when no pets are kept in the buildings. Adult fleas can be brought in on the clothing of staff, students, or visitors. Other possible sources include urban wildlife such as rats, raccoons, opossums, chipmunks, squirrels, feral cats, or birds that

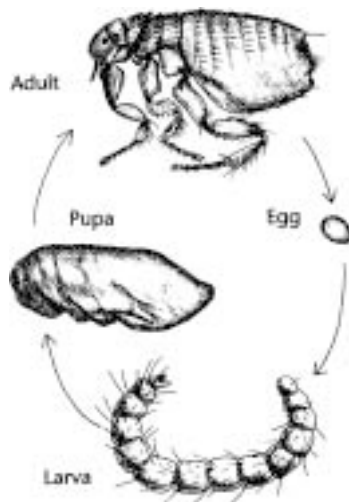

Figure 8-1. The Flea Life Cycle

---

may live in unused parts of the buildings.

### **Areas to Monitor**

- in and around the cages of pets kept in classrooms (also check the pets themselves for signs of fleas)
- places where animals might find harborage, such as basements, crawl spaces, attics, eaves, roof top structures, and secluded shrubbery near buildings

### **Monitoring Traps**

#### **Flea Sock Traps**

These are homemade, knee-high, white flannel booties that fit over the shoes and lower pant legs. When you walk through a flea-infested area, fleas will jump onto the flannel and become temporarily entangled in the nap where you can easily see and count them. Long, white athletic socks worn over the shoes and trouser legs will also work, as well as wide strips of sticky-backed paper wrapped around the lower legs (sticky side out). Socks can also provide protection from bites if a person must enter a severely flea-infested area for a short period of time.

#### **Light Traps**

These compact (roughly 4x6-inch) traps are composed of a small electric light and a sheet of sticky paper. Fleas attracted to the warmth and light get stuck to the paper. Research has shown that fleas are most sensitive to green light and are more attracted to light traps if the light is turned off for 10 seconds every 5 to 10 minutes (Pickens et al. 1987); therefore, it is important to choose a trap with a green light that can flicker on and off.

Light traps are especially useful for monitoring in office situations where no animals are present and the flea population is likely to be small. Check the traps once a week. If no fleas are caught by the second week, move the trap to another location or remove it. If the traps catch only a few fleas, the infestation is very small and can probably be controlled by the traps alone. In this case, leave the traps in place until no additional fleas have been caught for a week. If 20 or more fleas are caught per trap in a week, this probably indicates a more serious infestation, and time must be devoted to finding the source of the infestation (such as an animal living in or under the building).

#### **Persistent Flea Problems**

Persistent flea problems in buildings where there are no pets may indicate the presence of rodents or other wildlife. In this case it can be useful to have the fleas identi-

fied by a professional. When the flea species is not the cat flea, its identity can help determine the host animal and where to search to find the animal or its nest.

## **MANAGEMENT OPTIONS**

An integrated management program for fleas can be designed by selecting from the following strategies and tactics. See Box 8-A for a sample emergency flea control plan.

### **Physical Controls**

#### **Wild Animal Removal**

Wild animals can be removed with traps by trained animal control technicians. Consult your Yellow Pages or talk to your County Agricultural Extension agent for a recommendation. Make appropriate repairs to the building to exclude animals. For controlling rats and mice see Chapter 12.

#### **Vacuumping**

- Vacuuming on a regular basis throughout the year will keep developing flea populations low by picking up adult and egg-stage fleas.
- Vibrations caused by vacuum cleaners will stimulate pupal stage fleas to emerge, and the new adults can be captured in the next vacuuming.
- Vacuuming is not very effective at capturing flea larvae in carpeting because they coil themselves around the fibers. Vacuuming does, however, pick up the dried blood that larvae feed on.
- Use vacuum attachments to clean cracks and crevices. Caulk or seal these openings permanently.
- Most fleas will be killed when dust in the vacuum bag blocks their breathing apparatus, but to be sure, you can vacuum up a tablespoon of cornstarch.
- Vacuum badly infested areas thoroughly every day until the infestation is controlled.
- When infestations are severe, you may need to supplement vacuuming with steam-cleaning or other controls.

#### **Steam-Cleaning**

The services of a steam-cleaning firm may be warranted when flea populations are high. This process kills adult and larval fleas and probably some eggs as well; however, since the warmth and humidity from the steam also stimulates the remaining flea eggs to hatch a day or two after the cleaning, some fleas may reappear. If the other

### Box 8-A. Sample IPM Program for an Indoor Flea Emergency

If monitoring has confirmed a high indoor flea population that requires an immediate response, the following IPM program can be used to bring the emergency under control. A significant reduction of flea numbers should occur within one to two days.

1. **Protect Yourself.** Wear long pants tucked into boots or socks. For added protection, you may want to apply an insect repellent to pant legs and footwear.
2. **Vacuum and/or Steam-Clean Infested Areas.** Since most fleas reside in carpeting, it should be thoroughly cleaned. In uncarpeted areas, or where carpeting cannot be steam-cleaned, concentrate vacuuming along baseboards, under furniture, behind doors, or in other areas where dust collects and flea eggs are protected from foot traffic. See Physical Controls for more details.
3. **Apply an Insect Growth Regulator (IGR).** After completing steps 1 and 2 above, spray carpets and floor with an IGR such as methoprene or fenoxycarb (see Chemical Controls). The IGR will prevent pre-adult fleas that survive vacuuming or steam-cleaning from maturing to biting adults.
4. **Apply an Insecticide if Needed.** The first three steps described above should reduce the flea population to a very low level and keep it there while long-term measures (e.g., locating and removing wild animal flea hosts from the building) are undertaken. If sufficient control has not been achieved, apply a borate insecticide to carpeting or spot-treat infested areas with insecticidal soap or pyrethrin (see Chemical Controls). If adequate control has still not been achieved, apply a stronger insecticide, such as a synthetic pyrethroid. Follow all label directions to the letter and wear appropriate protective clothing.
5. **Remove Any Wildlife Nesting In Or Under Building.** If flea problems persist but no pet is present, check for wildlife in the vicinity of the building and remove the animal.

steps recommended in this chapter are followed—regular vacuuming, washing, etc.—the few fleas that hatch after steam-cleaning should represent the last of the flea population.

#### **Flea Combs**

Classroom pets in a flea-infested room should be combed regularly with a special flea comb that can be purchased at a pet store. Fleas and eggs removed from the animal should be dropped into soapy water.

#### **Laundry**

Wash removable floor coverings, such as rugs, located in areas where there are known infestations. Any bedding for classroom pets should be washed regularly.

#### **Heat**

Tests have indicated that cat flea larvae die after exposure to 103° F for one hour (Silverman et al. 1981), and researchers have developed techniques to raise the temperature in a room enough to provide this exposure (Forbes and Ebeling 1987). The heating process uses a common heating unit modified to include special blowers and flexible ducts. Companies have been using heat to kill termites and woodboring beetles for a number of years, and now some companies are experimenting with heat to control fleas. One potential problem with this technique is that fleas can burrow down into carpets and upholstery, and perhaps escape lethal temperatures.

#### **Drying or Flooding Infested Areas Outdoors**

Outdoors, organic matter can temporarily harbor flea larvae. Either drying out these areas or saturating them with water will kill the eggs and larvae (Silverman et al. 1981). You can also treat these areas with insect-attacking nematodes (see Biological Controls, below) or with an insecticidal soap (see Chemical Controls, below).

### **Biological Controls**

#### **Insect-Attacking Nematodes**

These microscopic, worm-like organisms live in the soil and kill insects by entering their bodies, feeding on tissue, and releasing harmful bacteria. These bacteria do not affect humans or other vertebrates. When they have eaten all they can of the insect, the nematodes leave to search for other prey. They cannot move far (only an inch or two) and die if they find no other insects. The nematodes sold for flea control are native to the United States and are found naturally in the soil all over the country; they will not adversely affect beneficial soil organisms, including earthworms.

---

### Tips for Using Nematodes

- Use the number of nematodes recommended by the manufacturer.
- Treat areas outside where you have found evidence of animals sleeping or areas that you know are regular travel routes for animals.
- Moisture is critical to the effective use of nematodes, so water the area before and after the application.

### Chemical Controls

If non-chemical methods alone prove insufficient to solve the problem, then integrating a pesticide into your management program may be warranted. For information on the hazards of various pesticides and on how to select an appropriate pesticide for your situation, consult Appendix G for a list of resources.

Pesticides must be used in accordance with their EPA-approved label directions. Applicators must be certified to apply pesticides and should always wear protective gear during applications. All labels and Material Safety Data Sheets (MSDS) for the pesticide products authorized for use in the IPM program should be maintained on file. Do not apply these materials when buildings are occupied, and never apply them where they might wash into the sanitary sewer or into outside storm drains.

### Insecticidal Soap

The insecticidal properties of naturally occurring fatty acids used to make soaps have been refined into a number of useful flea-control products. These insecticidal soap products can be found in pet stores and sometimes hardware stores. Some of these products contain 0.01% pyrethrins (discussed below).

Insecticidal soap can be used on pets, rugs, floors, and other places where flea eggs or young fleas may have collected. Outdoor areas can also be treated with insecticidal soap to reduce adult populations. Because this soap can kill a wide variety of insects, mites, and other arthropods (many of which are beneficial), it should be used outdoors only in spot treatments where wild animals nest, and only during periods of large flea infestations. Routine or random outside treatment or cover spraying is not advised. To locate areas with adult fleas, wear the flea socks described above (under Detection and Monitoring) and walk around the areas suspected of harboring fleas. If adult fleas are present, they will hop onto the socks where you can

easily see them and evaluate the degree of the infestation.

### Diatomaceous Earth and Silica Aerogel

These are insecticidal dusts that can be used for flea control. Diatomaceous earth is made from fossilized diatoms, and silica gel is produced essentially from sand. Both these products kill insects by desiccation; they absorb the wax and oil from the insect's outer covering which causes dehydration and death. Although these materials are not poisonous to humans directly, the fine dust travels freely through the air and can be irritating to the eyes and lungs; therefore, use a dust mask and goggles during application. Silica gel and diatomaceous earth are also formulated with pyrethrins (discussed below).

### How to Use Diatomaceous Earth and Silica Aerogel

- Apply a light dusting to upholstered furniture that is suspected of harboring fleas. Be sure to get into the cracks and crevices.
- Apply a light dusting to rugs or pet bedding.
- Apply to infested carpeting, leave for a couple of days, and then vacuum up.
- Dust into crawl spaces, wall voids, attics, and other similar spaces where you suspect animals of nesting or resting.
- Do not use in moist environments; neither material works well when wet.

### Citrus Oil Extracts (D-Limonene/Linalool)

D-limonene and linalool are citrus-peel extracts that have been used for years as food additives. Products that contain d-limonene kill larval and adult fleas, while those containing both ingredients kill all flea stages. EPA-registered citrus products can be used directly on pets, but veterinarians caution that some cats may suffer if the material is applied in excessive concentrations. These materials can also be applied to animal bedding but should not be used to spray entire rooms, nor should they be used outdoors.

### Borates

Sodium polyborate can be used in carpets to control flea larvae. The powder is worked into the nap of the carpet and then thoroughly vacuumed. This treatment will continue to kill flea larvae for as long as a year. Veterinarians sell sodium polyborate formulations for carpet application and there are also companies that provide this service.

### Insect Growth Regulators

---

Insect growth regulators (IGRs) arrest the growth of the flea at or before the pupal stage, but they do not kill fleas that have reached the adult stage before the material was applied. IGR products, such as methoprene and fenoxycarb, should be used before fleas reach the adult stage and only inside where severe infestations were previously located. Use liquid solutions and apply as spot treatments. Do not use aerosol foggers because much of the material falls on areas that will have no contact with fleas.

### **Pyrethrins and Synthetic Pyrethroids**

There are a number of flea control products containing pyrethrins and synthetic pyrethroids. These products should be used as a last resort in areas where fleas problems are severe. Apply as a spot treatment—do not use aerosol foggers.

## **BIBLIOGRAPHY**

- Bennett, G.W., and R.D. Lund. 1977. Evaluation of encapsulated pyrethrins (Sectrol™) for German cockroaches and cat flea control. *Pest Control* 45(9):48-50.
- Bio-Integral Resource Center (BIRC). 1996. 1997 directory of least-toxic pest control products. *IPM Practitioner* 18(11/12):1-39.
- Forbes, C.F. and W. Ebeling. 1987. Use of heat for elimination of structural pests. *IPM Practitioner* 10(5):1-6.
- Katz, H. 1992. Chemical addictions: Part V. *Pest Control Technology* 20(6):97-102.
- Klotz, J.H., J.I. Moss, R. Zhao, L.R. Davis, Jr., and R.S. Patterson. 1994. Oral toxicity of boric acid and other boron compounds to immature cat fleas (Siphonaptera: Pulicidae). *Journal of Economic Entomology* 87(6):1534-1536.
- Mallis, A. 1982. *Handbook of Pest Control*. Franzak and Foster, Cleveland. 1,101 pp.
- Olkowski, W., S. Daar, and H. Olkowski. 1991. *Common-Sense Pest Control: Least-toxic solutions for your home, garden, pets and community*. Taunton Press, Newtown, CT. 715 pp.
- Pickens, L.G., J.F. Carroll, and A.S. Azad. 1987. Electrophysiological studies of the spectral sensitivities of cat fleas, *Ctenocephalides felis*, and oriental rat fleas, *Xenopsylla cheopis*, to monochromatic light. *Entomologia, Experimentalis et Applicata* 45:193-204.
- Powers, K.A. 1985. Toxicological aspects of linalool: a review. *Veterinary and Human Toxicology* 27(6):484-486.
- Silverman, J., M.K. Rust, and D.A. Reiersen. 1981. Influence of temperature and humidity on survival and development of the cat flea, *Ctenocephalides felis* (Siphonaptera: Pulicidae). *Journal of Medical Entomology* 18(1):78-83.
- Tarshis, I.B. 1959. Use of sorptive dusts on fleas. *California Agriculture* 13(3):13-14.



# CHAPTER 9

## IPM FOR FLIES IN SCHOOLS

### INTRODUCTION

Many species of flies can be problems in schools. Each kind of fly has a distinct breeding site inside or outside the school building. In order to control pest flies, it is necessary to know which fly is causing the problem and

where it is breeding. Table 9-1 summarizes identifying characteristics of the most common pest flies encountered in schools.



House Fly

### Garbage- and Manure-Breeding Flies

#### IDENTIFICATION AND BIOLOGY

Flies such as house flies, dump flies, blow flies, and blue and green bottle flies which breed in food wastes (garbage) and/or animal feces are generally referred to as “filth flies.”

Sometimes flies are confused with wasps; however, flies have two wings, while wasps and all other winged insects have four wings arranged in two pairs, although sometimes the second set of wings may be covered or hidden by the first. Wasps, unlike flies, fold their wings alongside their bodies when at rest. Most pest wasps are colorfully marked with yellow, red, black, and white. These wasps are less likely to come indoors, they are aggressive in their flight around foods, particularly sweets, and they are larger than filth flies. Filth flies do not act aggressively and do not bite. The cluster fly, which is also larger than the filth flies, can be identified by its stout body with crinkled yellow hairs.

drains, in grass clippings allowed to rot in a pile, and even in moist soil that is mixed with garbage. The larva hatches from the egg and grows until it is ready to form a puparium (a kind of cocoon) from which an adult fly will emerge. Once the adult fly emerges, it doesn’t grow any larger; small flies do not grow into larger flies.

#### DAMAGE

Flies that invade cafeterias and kitchens carry bacteria and other microbes which contaminate food, utensils, and surfaces. It is good hygienic practice to prevent this exposure.

#### DETECTION AND MONITORING

It is important to correctly identify the problem flies and pinpoint their breeding sites. Table 9-1 can help you with identification, or you can take several specimens to a specialist. The specialist should be able to tell you what kind of breeding site to look for after an identification has been made.

To collect specimens inside, use sticky flypaper or gather dead specimens from windowsills and light fixtures. Outside, trapping is one of the easiest methods of catching flies for identification (see the discussion below for trap construction, placement, and baits). If adult flies consistently avoid baited traps, it may indicate that the pest fly is not a filth fly. In this case, you can try using a butterfly net to catch one of the flies.

#### MANAGEMENT OPTIONS

To manage flies, you must find and reduce breeding sites, install and maintain screens to keep flies out of buildings, kill those flies that do get inside with a fly swatter or flypaper, and reduce or eliminate the odors that attract flies.

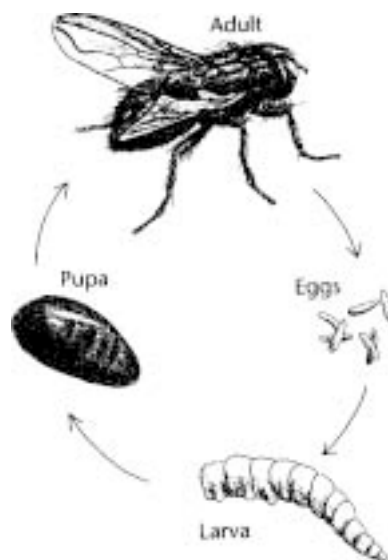

Filth flies pass through four distinct stages in their life cycle: egg, larva (maggot), pupa, and adult (see Figure 9-1). Adult female filth flies look for a moist place with the right smell to lay their eggs. This can be in food waste in a garbage can or dumpster, in dog or cat feces, in dead animals, in kitchen

Figure 9-1. Life Cycle of a Fly

In a school with a frequent waste removal program, it is very possible that few flies are breeding on the school property. It is more likely that odors from dumpsters, garbage cans, kitchens, and cafeterias are attracting flies to the school from the surrounding neighborhood. House flies and blow flies, the species that most commonly invade buildings, usually develop outside and follow odors into the building. They can also be pests when students or staff are eating outside. In schools where waste removal is infrequent, fly populations can be breeding at the waste collection site.

### Habitat Modification

This is one of the most important aspects of fly control. Without controlling wastes and odors, it is impossible to control filth flies.

### Food Waste

- All food waste from the kitchen, cafeteria, and other areas should be separated from other garbage, drained so it will be as dry as possible, and then stored in sealed plastic bags before discarding.
- Place containers with small amounts of food waste, such as milk or yogurt cartons, into sealed plastic bags before disposal. This method will reduce access to flies (and yellowjackets).
- Promptly fix drains or electric garbage disposal units that leak, or drains that allow food waste to accumulate under sinks or floors. Leaky drains can attract many species of flies. Remove any food waste that has accumulated under sinks or floors or in crawl spaces or basements at the site of the broken drain, and then clean the area thoroughly.

**Table 9-1. Common Flies Found in and around Schools**

Common Name	Scientific Name	Description	Sources
House Fly	<i>Musca domestica</i>	medium-sized, gray; 4 stripes on thorax	garbage, human and animal manure
Dump Flies	<i>Ophyra</i> spp.	medium-sized; black	mixed garbage, bird feces; in the Pacific Northwest, sometimes replaces the house fly as the main indoor pest
Black Blow Fly	<i>Phormia regina</i>	large; dark blue	garbage, animal carcasses; most abundant in early spring
Green Bottle Fly	<i>Phaenicia sericata</i>	medium-sized; shiny green to bronze	garbage containing mixtures of animal and vegetable matter, dead animals, fresh meat; enters buildings less frequently than house flies
Blue Bottle Flies	<i>Cynomyopsis cadaverina</i> <i>Calliphora</i> spp.	medium-sized; thorax dull, abdomen metallic blue	exposed meat, feces, overripe fruit and other decaying vegetable matter; enters buildings in cool seasons
Little House Fly	<i>Fannia canicularis</i>	small, dull gray, yellow on upper abdomen; males circle in the air	decaying vegetable and animals matter, especially the manure of humans, horses, cows, poultry, and dogs; also piled, moist, grass clippings
Cluster Fly	<i>Pollenia rudis</i>	larger than house fly; dark gray with distinctive yellow hairs; adults sluggish	larvae parasitic on earthworms; adults enter houses in fall
Fruit Fly	<i>Drosophila</i> spp.	very small; yellow-brown	fermenting fruit and vegetables, other moist organic matter
Phorid Fly (Drain Fly)	<i>Megaselia scalaris</i>	similar to fruit fly, but more humpbacked in appearance	decomposing organic matter including vegetables, fruit, flesh, feces



---

## Other Garbage

- In food preparation areas, rinse all cans, bottles, and plastic containers before recycling or discarding.

## Exterior Garbage Cans and Dumpsters

- To avoid attracting flies into the building, place dumpsters and recycling containers upwind from the outside doors of the school, particularly doors to the kitchen or cafeteria. When dumpsters are downwind, flies are attracted to the waste odors and then find the odor trails that the breeze blows down from the doorways. Following these odor trails, they find their way into the building.
- Wastes should be collected and moved off site at least once a week. In hot months, garbage collection twice a week will significantly reduce fly problems.
- Make sure garbage can and dumpster lids seal tightly when closed and remain closed when not in use. Do not leave lids open at night; garbage can attract other pests, such as rodents. Repair or replace garbage cans with holes or with lids that do not close tightly. For more information on rodent-proof garbage containers, see Chapter 12, IPM for Rats and Mice.
- Regularly clean garbage cans and dumpsters to prevent the build-up of food waste, an ideal place for flies to lay eggs. Use a high pressure stream of water or a brush and soapy water, if necessary. A solution of borax and water will eliminate odors. Do not allow soured milk to collect in trash receptacles; it is a powerful attractant to flies. If possible, dumpsters should be fitted with drains so they can be hosed or scrubbed out as needed. Another option is to require the refuse company to clean the dumpster or replace it with a clean one more frequently.
- Flies can develop in soil soaked with water used to clean garbage cans and dumpsters. Check these areas regularly. If you see maggots, scrape them up along with the soil and dispose of everything in a plastic bag sealed tightly with a knot or a twist-tie.
- Do not store extra garbage outside of dumpsters or garbage cans in cardboard, plastic, or paper; this provides easy access for rats, dogs, raccoons, or other animals.
- Inspect dumpsters and other outdoor trash receptacles at the end of the day and remove any wastes lying on the ground.
- Garbage cans on the school grounds should have removable domed tops with self-closing, spring-

loaded swinging doors. Cans should be lined with plastic bags that can be tightly sealed and removed daily.

- Inform students, teachers, and staff of the importance of placing garbage inside the proper containers. Garbage should not be left lying on the ground.

## Animal Feces

Remove droppings promptly and put them into plastic bags that are sealed before disposal. Dog feces that dry quickly may attract adult flies with their odor but are unlikely to host many maggots. Droppings that remain damp because of humidity or rain can breed a number of maggots.

## Odors

Flies can detect odors over long distances. Smells of souring milk from hundreds of containers thrown in dumpsters can attract thousands of flies from the surrounding neighborhood. Storing garbage in sealed plastic bags and having cans and dumpsters cleaned and emptied frequently to eliminate odors is very important. Removing pet feces also helps reduce attractive odors.

Flies attracted to open kitchen or cafeteria doors, or to dumpsters or garbage, will rest on nearby walls, eaves, and rafters. While resting, they leave fly specks, which have a strong fly-attracting odor. These brown- to cream-colored specks should be washed off with an odor-eliminating cleaner (a mild solution of borax and water can be particularly effective) otherwise they will continue to attract flies.

## Physical Controls

### Screens

Install screens over windows, doors, and vent holes to prevent flies from entering buildings. Weather-stripping or silicone caulk can be used to insure a tight fit. Torn screens can be repaired with clear silicone caulk. Screen doors should be fitted with springs or automatic closing devices that close the screen door firmly after it is opened. External doors that cannot be screened should be fitted with automatic closing devices, and/or vertical strips of overlapping plastic that allow human access but prevent fly entry. “Air walls” that force air across openings are another alternative to screen doors.

### Fly Swatters

In many instances, the old-fashioned fly swatter is the safest and quickest way to kill flies that have found their way into a room. Aim the fly swatter about 1 1/2

---

inches behind the fly, rather than directly at it, because research has shown that when a house fly takes off from a horizontal surface, it jumps upward and backward. Stiff plastic swatters seem to work better than wire-mesh ones. The fly's unblurred range of vision is about 1 1/2 feet, and the swatter can be moved to this distance before striking (Tierney 1988).

### **Flypaper**

Sticky flypaper is effective at catching flies because it takes advantage of their natural habit of moving up to the ceiling to rest. It will take several days for a new strip of flypaper to start catching flies. Use a number of strips at a time and replace them when they are covered with flies or when they begin to dry out. Flypaper can be very useful in areas where there are too many flies to kill with a fly swatter, and where aesthetic appeal is not of primary importance. Flypaper is also a useful monitoring tool.

### **Fly Traps**

Fly traps can be used to reduce adult fly populations, capture specimens for identification, and monitor the effectiveness of control programs. Fly traps are not toxic and are more selective than using insecticide. Traps need to be serviced regularly, appropriately placed, and repaired or replaced when damaged.

### **Trapping Flies Indoors**

Electrocuting light traps are preferred for indoor use and can be used in food preparation and storage areas. Light traps will not work well in a room with many and/or large windows because the bright light coming in the windows is a much more powerful attractant than the comparatively weak light coming from the trap.

Contrary to the advice provided in some promotional literature for ultraviolet light or electrocutor traps, these traps should not be used outdoors. They are relatively non-selective in the insects they attract and will kill many more beneficial and innocuous insects than pests.

The following are key points to remember when using light traps for indoor flies:

- Use the number of traps recommended by the manufacturer, or, as a general rule, one trap for every 30 feet of wall.
- Mount traps 3 feet from the floor on the perimeter walls of the room, because hungry flies circle the perimeter of a room close to the floor when looking for food.

- Mount traps 5 feet away from any open food and 25 feet from any doors or windows. Traps work best in rooms without windows.
- Empty and clean the traps weekly to prevent dermestid beetles from developing in dead flies.
- Replace lamps at least once a year.
- The more expensive black light "blue" bulbs do not attract more flies than regular black light bulbs.
- The lamp should be directed toward the interior of the building. Do not place traps where flies that are outside can see the light bulb. This may attract more flies.
- Place traps near odor sources (such as cooking areas, garbage cans, outdoor restrooms), since odors will be more attractive (especially from a distance) than the light.

### **Trapping Flies Outdoors**

To capture flies outside, use traps with a screen cone suspended above the bait. These cone-type traps take advantage of the fly's habit of flying or walking toward light. Cone traps can be easily made from wood together with aluminum or plastic screening; use the dimensions in Figure 9-2. Flies are attracted to the bait in the pan under the trap. Once the flies are under the trap, the brightest spot they see is the hole in the cone above them. They walk up through the hole and are trapped in the outer screen cage. Since flies are attracted to the light and it is always lighter above them, they do not find their way back out through the hole in the cone.

The following are key points to remember when trapping flies outdoors:

#### **Trap placement is important.**

- If an area has a small or moderate fly problem, traps placed close to buildings can attract flies from all over the neighborhood and make the problem worse. It is better to set the traps close to fly breeding sites with any prevailing breeze blowing from the trap toward the breeding area.
- Since most bait odors are heavier than air, place traps so odors flow over the area where flies are developing.
- Do not set traps near doorways or entrances to buildings.
- Place traps away from outdoor areas that are used for eating or recreation.

- Generally, traps are most effective when placed on the ground, but they can be hung over the openings of dumpsters and from buildings or fences as well. Traps hung in these areas must not interfere with the opening and closing of the dumpster, and should be placed in areas where people will not tamper with them and will not be offended by the bait odors.
- Place traps in sunlight. Flies are more active in sunlight, both outside and inside the trap. Flies buzz more in the sunlight, and the noise coming from the trap will attract additional flies from a distance. Yellowjackets are also attracted to the buzzing and will enter the cone trap in search of food.

#### Empty the trap to maintain performance.

Empty the trap when dead flies cover about one quarter of the cone. Do not release live flies that are in the trap.

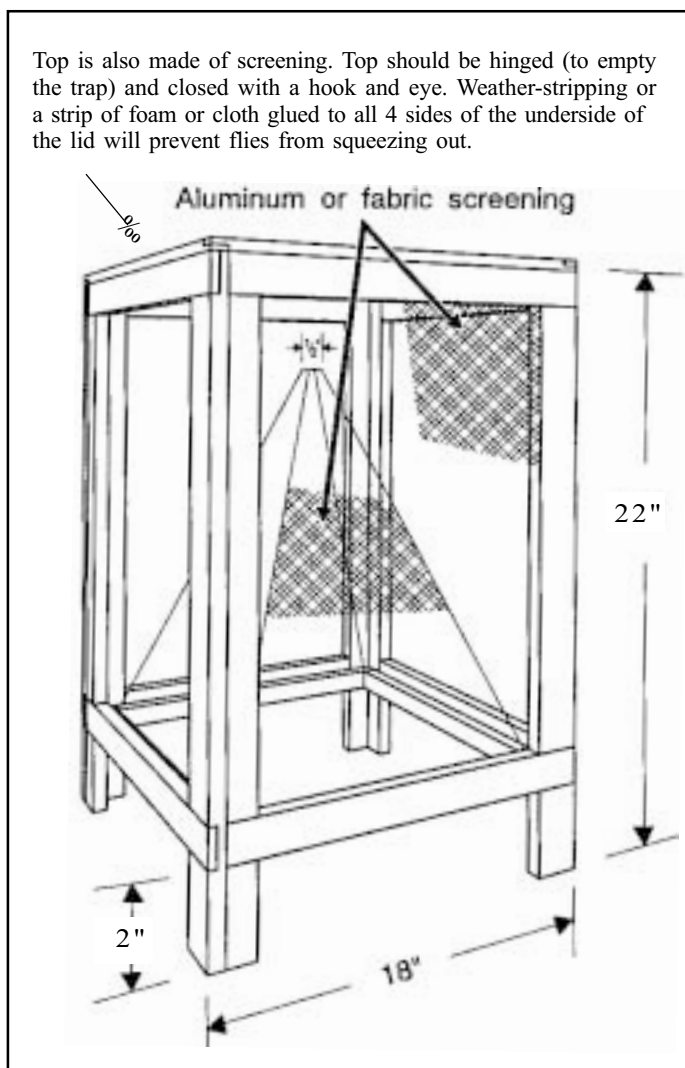

Figure 9-2. Cone Trap. Bait pan is placed beneath bottom of the cone. Make sure the top edge of the bait pan is above the bottom edge of the trap.

Kill them by enclosing the trap in a plastic bag and placing it in the sun. After the flies are dead, the contents of the trap should be poured into the plastic bag, sealed, and discarded in a dumpster or garbage can.

#### Do not clean the trap between uses.

The smell of the millions of fly specks deposited on the screen is very attractive to flies.

#### Bait is important to the performance of the trap.

- Liquid bait, either the Yeast Bait or the Beltsville Bait (see Box 9-A for recipes), is a superior attractant that will not breed flies unless it is allowed to dry to a sludge. If either of these baits contaminate clothing and hands, use baking soda and water to remove the odors.
- Yeast Bait has a foul odor that is particularly attractive to female flies because it smells like a good place to lay eggs. This bait will lure flies even from the most attractive breeding sites.
- Beltsville Bait will attract male flies as well as females because it contains sugar. This sweet bait can be used in cool weather when the main aim of trapping is to reduce the total number of flies rather than to suppress breeding.
- Baits such as decaying meat or fish scraps will attract mainly blow flies and flesh flies. These baits should always be put inside a rolled down plastic bag and then placed in the bait pan. Watch the bait so that it does not become a breeding site for flies. The larvae feeding on the bait can crawl out of the plastic bag and away from the trap to pupate. If larvae are found in the bait, the plastic bag should be sealed, thrown away, and replaced with a new bag and bait.
- Sex pheromone baits for flies do not last long and do not attract flies from a distance. They are likely to be more expensive and less effective than other food-type baits which can be mixed from common materials and attract both sexes.
- Do not add poison to the bait. Flies are more attracted to the live flies in the trap than they are to dead ones.
- The top edge of the bait pan must be at least 1/2 inch above the bottom edge of the trap. If flies can sit on the top edge of the bait pan and look out under the trap, trap catches will be poor.

#### Prevent excessive amounts of water from getting into the trap.

If dead flies in the trap get wet and begin to rot, they will attract blow flies that will lay their eggs on the outside of the screen. When the tiny blow fly larvae hatch, they crawl through the screen to feast on the rotting mass of

## Box 9-A. Fly Bait Recipes

### Liquid Yeast Bait

(from Satrom and Stephens 1979)

This recipe makes 7-9 portions of liquid bait for use with a cone trap. It can be stored 20-30 days once it is ready for use.

#### Ingredients:

2 quarts tepid (not hot) water (95-105° F)  
1 cup + 3 oz. active dry yeast (baking yeast)  
2 tablespoons ammonium carbonate (optional\*)

#### Mixing the bait:

Use a plastic (not glass) narrow-necked gallon jug with a screw cap for mixing, ripening, and storing bait. Bleach or milk jugs work well. Wide-mouth containers will not produce effective bait.

Mix all the above ingredients in the jug. Important: With cap lightly sealed, allow mixture to begin to ripen (see ripening instructions below). It will foam up at first. After it subsides (1-2 days), tighten the lid and continue ripening till very smelly (2-9 additional days). Gases must escape while bait is foaming up (loose cap), but bait must finish ripening without air (tight cap) to attract flies.

#### Ripening the bait:

Allow bait to ripen 4-10 days in a place where temperatures remain above 60° F during the night and day. Bait is ripe when it is very smelly, with a musky, penetrating odor. Warm daytime temperatures will make up for slightly cooler (less than 60°F) nights, but in general, the warmer the average temperature, the faster the bait will ripen. Because of its heavy odor, the bait should be ripened in a well-ventilated area where it will not offend people. Do not ripen or store the bait in direct sunlight. Extreme temperatures can build within the jug, kill the yeast, and cause gases to expand enough to pop off the lid or break the jug.

#### Storing the bait:

To maintain potency, store bait with the cap kept tight. Open the jug only when necessary to refill the bait pan. Do not store in direct sunlight.

\*Ammonium carbonate is available from chemical supply houses and will improve the odor of the bait.

Note: Ripened bait should be treated as a decaying food material. It can cause gastro-intestinal disturbances if ingested.

#### Using the bait:

Stir or shake the bait supply each time before adding to the bait pan. Pour about 1 cup (8 ounces) of bait in a wide pan on a level surface under the trap. Be sure the edge of the pan is higher than the bottom edge of the trap frame.

The bait is effective in the pan for at least 3 to 5 days. It attracts more flies on the first day, and then gradually declines thereafter. Don't let the bait dry out.

---

### Beltsville Bait

(from Pickens, et al. 1994)

This makes a dry bait that can be easily stored for a considerable time. It must be mixed with water before using.

#### Ingredients:

1 pound granulated sugar  
1 pound baking powder (double-acting type)  
2 ounces dry active yeast (baking yeast)  
6 ounces air-dried blood or freeze-dried fish meal  
1/4 cup honey  
2 tablespoons\* water

#### Procedure:

Mix ingredients thoroughly. Press mixture into a plastic ice-cube tray to form cubes. Invert the tray to dump the cubes, and let them dry to form hard blocks. To use the bait, add 2 cubes of bait to 2 quarts of water. Place bait in a wide-mouth pan beneath a cone-type trap. Flies are attracted to this bait from only a short distance, so traps should be placed within 6 feet of areas where flies are active. Bait pans should be cleaned and baited every 1 to 2 weeks and should be kept filled with water.

\*Quantity of water needed may vary with humidity of air when mixing. Use only sufficient water to bind dry ingredients together when they are compressed.

---

flies. This turns the trap into a messy breeding site for flies.

- Do not place traps where sprinklers will get them wet.
- In areas where there are frequent rainstorms during the trapping season, it may be necessary to fit the trap with a clear Plexiglas™ top.

### **Chemical Controls**

Except for odor-eliminating chemicals such as borax, pesticides are not recommended for fly control.

### **Borates**

Low concentrations of borax in water can be used to

## **Fruit Flies, Cluster Flies, and Phorid Flies**

cleaning rags as well as residues in bottles, cans, garbage disposals, and drains). Their life cycle, from egg through maggot and pupa to adult, takes little more than a week, and the number of flies that can be produced by a single piece of fruit is enormous. These flies are most often a problem in late summer and early fall, so careful storage of fruit and vegetables is necessary at these times of the year.

### **Cluster Flies**

Cluster flies are larger and darker than house flies and have a distinctive yellowish color caused by the crinkled yellow hairs on their bodies. In the summer, cluster flies lay their eggs in soil where the maggots parasitize earthworms. Soil containing many earthworms—for example, large lawn areas on the school grounds or in nearby parks—is a common source of these flies. In the fall, the adults can be seen clustering on the south and west sides of buildings. As the weather gets cooler, these flies begin looking for sheltered places to spend the winter and often enter buildings.

### **Phorid Flies**

The most common phorid fly, *Megaselia scalaris*, is small (1/16 to 1/8 inch) with a yellowish-brown body and light brown wings. The adults seem reluctant to fly, and they run around on walls, windows, and tables with a characteristic quick, jerky motion. The females are strongly attracted to odors and lay their eggs on or next to decaying material, both plant and animal. Food sources for the larvae are highly varied, from decomposing fruit, vegetables, and meat to open wounds in animals and people, and human and animal feces. The life cycle from egg to adult takes from 14 to 37 days.

eliminate fly odors. This solution is particularly effective for removing fly specks from walls and eaves, and for rinsing out garbage cans and dumpsters. These solutions should not be used near ponds, streams, lakes, or other bodies of water, and should not be poured onto plants.

## **IDENTIFICATION AND BIOLOGY**

### **Fruit Flies**

These small flies are commonly seen flying around ripe fruit, especially bananas. They are about 1/8 inch long and usually have red eyes. They lay their eggs near the surface of fermenting fruits and vegetables and other moist organic materials (including damp mops and

## **MANAGEMENT OPTIONS**

### **Fruit Flies**

Fruit flies are most active from late summer through early fall. Problems with these flies can be avoided by ripening fruit in paper bags. Seal the bags by folding the top over several times and closing it with a paper clip or clothes pin. Once fruit is ripe, it should be stored in the refrigerator. Careful storage of fruit during the rest of the school year may not be necessary.

If an infestation is discovered, look for and remove the material that is breeding the flies. Begin by searching for the obvious sources, such as ripe fruit and vegetables, and then look at water from refrigerators, humidifiers, or sink drains that may be fermenting; spoiled animal food; or even damp, sour mops or rags. Areas outside the building near windows and doors should be checked for rotting vegetable matter. All breeding sources should be removed and disposed of in a sealed plastic bag. Make sure that screens and windows near food preparation areas are in good repair.

### **Fruit Fly Trap**

To make a simple trap for fruit flies, combine 1 cup of vinegar, 2 cups of water, and 1 tablespoon of honey in a 2-liter soda bottle. Replace the cap, shake the mixture well, and punch holes in the side of the bottle above the liquid so the flies can get in. Using string, hang the bottle about 5 feet from the ground. Periodically, dump out the dead flies.

### **Cluster Flies**

Cluster flies are not as strong fliers as house flies and can easily be killed with a fly swatter or removed with a

---

vacuum. Cluster flies can also be allowed to exit by opening the window. They can find their way into buildings through unscreened doors and windows, openings under siding and around roofs, unscreened ventilating spaces, cracks around windows, and holes where wires penetrate the walls of the building. During warm winter periods, cluster flies hidden in buildings become active and are attracted to windows.

### Phorid Flies

Phorid flies breed in diverse sources of organic matter, so it may take considerable sleuthing to find their breeding sites. Once the site is found it must be thoroughly scraped, cleaned, and dried. Large infestations of these flies are often the result of broken drains or garbage disposals that allow organic matter to accumulate in out of the way places such as wall voids, under floors, in basements, or in the soil of crawl spaces.

### BIBLIOGRAPHY

- Baur, F.J., ed. 1984. *Insect Management for Food Storage and Processing*. American Society of Cereal Chemists, St. Paul, MN. 384 pp.
- Campbell, E. and R.J. Black. 1960. The problem of migration of mature fly larvae from refuse containers and its implication on the frequency of refuse collection. *California Vector Views* 7:9-15.
- Drummond, R.O., J.E. George, and S.E. Kuntz. 1988. *Control of Arthropod Pests of Livestock: a review of technology*. CRC Press, Boca Raton, FL. 245 pp.
- Gilbert, D. 1984. Insect electrocutor light traps, pp. 87-108. In: Baur, *Insect Management for Food Storage and Processing*. American Society of Cereal Chemists, St. Paul, MN.
- Greenberg, B. 1971. *Flies and Disease, Volume I: Ecology, classification, and biotic associations, and Volume II (1973): Biology and Disease Transmission*. Princeton University Press, Princeton, NJ. Vol. 1, 856 pp. Vol. 2, 447 pp.
- Oldroyd, H. 1964. *The Natural History of Flies*. W.W. Norton, New York, NY. 324 pp.
- Olkowski, H., W. Olkowski and T. Javits. 1979. *The Integral Urban House*. Sierra Club Books, San Francisco, CA. 494 pp.
- Olkowski, W., S. Daar, and H. Olkowski. 1991. *Common-Sense Pest Control: Least-toxic solutions for your home, garden, pets and community*. Taunton Press, Newtown, CT. 715 pp.
- Pickens, L.G., E.T. Schmidtman, and R.W. Miller. 1994. *How to control house and stable flies without using pesticides*. U.S. Department of Agriculture, Washington, D.C., USDA Information Bulletin #673, 14 pp.
- Richardson, J. 1994. Echoes from our network. *Echo Development Notes* (46), October. North Fort Myers, FL. 6 pp.
- Satrom, G. and D. Stephens. 1979. *A Fly Control Handbook, IPM for Manure and Compost Ecosystems*. Beneficial Biosystems, Emeryville, CA. 42 pp. (out of print).
- Tierney, J. 1988. The right way to swat a fly. *Pest Control Technology* 16(8):36-40.

---

# CHAPTER 10

## IPM FOR SCHOOL LAWNS

### INTRODUCTION

In schools, lawns often cover several acres, and serve important roles as athletic fields, picnic lunch sites, outdoor classrooms, and general recreational areas for the community at large.

Heavy use of lawns and athletic fields causes stress that predisposes grass to attack by a variety of weeds, pest insects, pathogens, and vertebrates such as gophers and moles. As a result, most pesticides used on school grounds are applied to lawns.

Because the bodies of children and youths are often in direct contact with the grass, use of pesticides on lawns increasingly raises concerns among parents and health professionals. On the other hand, coaches and school administrators are under pressure to insure quality turf for use by students and by community athletic leagues. In addition, the competence of landscape maintenance staff is often judged by the aesthetic appearance of the lawns that surround most schools. These various viewpoints often come into conflict when pests threaten lawns.

The key to lawn IPM is the use of cultural practices that optimize growth of grasses and minimize conditions favorable to pest insects, weeds, or pathogens. The following discussion describes how to implement an IPM approach to lawn care. Since specific methods for managing all possible lawn pests is beyond the scope of this chapter, a general IPM approach is described, followed by complete management programs for two typical lawn pests: chinch bugs and fusarium blight.

### DETECTION AND MONITORING

An IPM approach to lawn management begins with a monitoring program. Monitoring entails making regular inspections of the lawn to gather and record site-specific information on which to base pest control decisions. Monitoring enables pest managers to do the following:

- identify the pest(s)
- identify any natural enemies of the pest(s)
- apply preventive methods to reduce the occurrence of pest problems
- determine if any treatment is needed

- determine where, when, and what kind of treatments is needed
- evaluate and fine-tune treatments as the pest management program continues over the seasons

Tools used to monitor lawns are listed in Box 10-A.

### Developing Background on Local Pests

When beginning a monitoring program, some effort should be made to become familiar with the common pest insects, weeds, and lawn pathogens found in the local area. Learn about their life cycles and how to recognize them. This information can be obtained from the Cooperative Extension Service, located in every county, or from publications listed in the Bibliography at the end of this chapter. It is also important to learn to recognize the natural enemies of common lawn pests, and factor their presence into deciding if treatments are needed and which ones to use.

### Gathering Background Data on the Site

The next step in a monitoring program is to map all lawn areas, noting locations of existing pest problems or conditions that can produce pest problems (bare spots, broken sprinkler heads, etc.). Identify the lawn grasses in each area and record the maintenance history of the turf and current horticultural practices. Soil should be tested at representative sites to assess fertility status and requirements. If any pest organisms are present, be sure to get an accurate identification. Many unnecessary pesticide applications can be traced to mistaken identification of pests.

Next, give each major section of lawn an identifying number and prepare a monitoring form for recording on-going maintenance activities and information about pests and their management in each section of lawn.

You will need to compile an inventory of existing lawn maintenance equipment. In addition to mowers, is there an aerator, de-thatcher, and fertilizer spreader that can handle sludge or other organic materials? Is there a spring-tooth harrow for removing weeds from infields and running tracks? These are useful tools in non-chemical lawn management. Prepare a list of equipment that is needed so it can be worked into the

### Box 10-A.

#### Tools Used to Monitor Lawns

The following tools are useful for monitoring lawns. They can be carried in a sturdy bag designed to transport baseball equipment (available at most sporting goods stores). The soil probe with its extension fits snugly in the bottom pocket designed for baseball bats, and everything else fits into an upper zippered area.

- soil probe
- pH meter
- soil thermometer
- 10-power hand lens (magnifying glass)
- watering can and bottle of detergent
- plastic bags for collecting specimens
- clip board and forms for recording data
- a ball of twine or clothesline for taking transects
- a small hand trowel and knife
- camera
- field guides for identifying pests and natural enemies
- pheromone traps for cutworms, sod webworms, etc.

budget process. Inspect the condition of the equipment. Are mower blades kept sharp? Can mowing height be adjusted easily? Does the equipment have flotation tires to reduce soil compaction?

#### Developing Pest Tolerance Levels

Most lawns can tolerate some pest presence without compromising appearance or function. The challenge for the pest manager is to determine how much damage is tolerable and when action is needed to keep pest damage within tolerable levels. Since the competing interests in the lawn mentioned earlier must be taken into account when deciding whether or not treatments are warranted, it is good practice to involve representatives of these interest groups in setting pest tolerance levels for lawn areas.

One approach is to work with an IPM advisory committee (discussed in Appendix B) to develop pest tolerance levels for lawns at each school site. Toler-

ance levels will differ, depending on location and uses of the lawns. For example, tolerance for pest presence on lawns at the front of the school in public view may be lower than tolerance on playing fields behind school buildings. Tolerance levels may also differ depending on the particular pest. For example, tolerance for damage by pest insects or pathogens that can kill large areas of turf, leaving bare soil, may be lower than tolerance for weeds that displace grasses but nevertheless continue to cover soil and serve as a playing surface.

Tolerance levels can be quantified in a number of ways. Box 10-B describes a method for quantifying the amount of weeds growing in a lawn. This permits expression of tolerance levels by percentage of weeds, for example, “up to 25% weed growth is tolerable on the back lawn at the elementary school; only 10% is tolerable on the football field at the high school.”

Tolerance for insect damage can be correlated with numbers of insects present and amount of visible damage. For example, white grubs can be monitored by examining several areas of soil underneath the grass. A spade is used to cut three sides of a 1-foot square of grass. The grass is carefully folded back, using the uncut edge as a hinge. Dirt from the roots is removed, and the number of exposed grubs counted. Then the grass can be folded back into place, tamped, and watered in. In well-managed lawns, up to 15 grubs per square foot can be present without causing any appreciable damage to the turf. In stressed or poorly managed lawns, however, 15 grubs per square foot might seriously damage the grass.

By setting tolerance levels, pest managers and groundskeepers can gear their management efforts to keeping pest populations within tolerable levels, and apply treatments only if, when, and where necessary. By involving members of the school and community in setting treatment guidelines, confrontations can be minimized and broad support developed for the IPM program.

#### Evaluating Pest Management Practices

When actions are taken to reduce pest presence, monitoring data should be used to evaluate the effectiveness of the treatment. Did pest numbers go down sufficiently to prevent intolerable damage? Were treatments cost-effective? Is the problem likely to recur? Can conditions causing chronic pest problems be altered or removed? If not, can other ground covers better suited to conditions at the site replace the lawn?

## MANAGEMENT OPTIONS



## Box 10-B.

### The Transect Method for Monitoring Weeds in a Lawn

- At the beginning and at the end of the season, establish three parallel transect lines along the length of the field. Use the center of the field and two imaginary lines on either side.

Note: Three transects will give sufficient data to indicate percentage weed cover in the total turf area. If time is limited, information recorded from one transect across a representative area of turf (e.g., down the center of the field) may give sufficient indication of weed trends for management purposes.

- Calculate the number of paces you will walk between samples.
  - Measure the length of one of your transect lines in feet (e.g., 360 ft).
  - Measure the length of the pace of the person doing the transect. To do this, slowly walk a known length (e.g., 20 ft), count the number of paces it takes to cover this distance (e.g., 10 paces), and divide the distance by the number of paces (20 ft divided by 10 paces = 2 ft per pace) This figure represents the average length of the pace.
  - Divide the length of the field by the length of the pace (360 ft divided by 2 ft per pace = 180 paces). This establishes the number of paces it takes to walk the transect.
  - Divide the number of paces by the number of samples to be recorded (a minimum of 20 samples is recommended): 180 paces divided by 20 samples = 9 paces per sample. Thus, in this example, a sample will be taken every 9th pace along the transect.

- Stretch lines of string along the three transect lines, laying the string directly on the ground.
- Beginning at one end of the first transect, walk the calculated number of paces (9 paces in the above example), stop and look at a 3 x 3 inch area (this is about the circumference of a softball or the lid to a 1 lb coffee can) immediately in front of your toe.

If this area contains part or all of a weed, check the 'yes' box on the first line under 'Transect A' on the monitoring form (see Figure). If you know the identity of the weed, write it down.

If the toe sample area contains grass, check the 'no' box on the monitoring form. If 25% or more of the toe area sample is bare soil, check the box marked 'bare.' If less than 25% is bare, but a weed is present, check 'yes.'

Continue pacing the transect line and marking the monitoring form. Repeat along the two other transect lines.

- To calculate the average percentage of weeds, total the number of boxes marked 'yes' in each column and

#### Weed Monitoring Form for Turf

Location of Turf \_\_\_\_\_ Date \_\_\_\_\_  
 Data collected by \_\_\_\_\_ Length of pace \_\_\_\_\_  
 Distance between sampling points on transect \_\_\_\_\_  
*(for example, every nine paces)*  
 Number of transects \_\_\_\_\_ Length of transects \_\_\_\_\_  
 Sketch of location of transects \_\_\_\_\_

	Transect A			Transect B			Transect C			Weed		
	Yes	No	Bare	Weed I.D.	Yes	No	Bare	Weed I.D.	Yes		No	Bare
1				1				1				
2				2				2				
3				3				3				
4				4				4				
5				5				5				
6				6				6				
7				7				7				
8				8				8				
9				9				9				
10				10				10				
11				11				11				
12				12				12				
13				13				13				
14				14				14				
15				15				15				
16				16				16				
17				17				17				
18				18				18				
19				19				19				
20				20				20				

Average % weed growth \_\_\_\_\_ Average % bare area \_\_\_\_\_

*Total the number of boxes marked 'Yes' in each column. Multiply this number by 100 and divide by 60 (the number of samples taken). The result is the average percentage of weeds growing in the turf area. Follow the same procedure to calculate percentage of bare area.*

multiply by 100. Divide this number by the total boxes in all columns. The resulting figure represents average percent weed cover in the turf. Do the same calculation with the boxes representing bare ground. This will indicate percent area that will become weedy if not seeded to grass.

- By collecting data from the transects at the beginning and end of each season, the turf manager can spot emerging problem areas. For example, if several boxes in succession are marked 'yes' indicating weed presence, a closer look at this area on the transect is warranted. Usually such 'clumping' of weed growth indicates exceptionally heavy wear on the turf, although structural problems such as severely compacted soil, a broken irrigation line, inoperative sprinkler head, scalping of the turf due to uneven grade, etc., also may be indicated.

By monitoring the turf area from season to season, the manager can tell if weed populations are rising, falling, or remaining relatively stable. This information will indicate whether or not current turf management practices are keeping weeds at or below the agreed-upon tolerance level. If weed populations are rising, changes in management practices are indicated.

---

When pest numbers threaten to exceed tolerance levels (i.e., the action level is reached), there is a wide variety of strategies and tactics available to solve any lawn pest problem. The first approach is to address conditions causing stress to lawns.

### **Stress and Pests**

The pest problem of greatest concern on school lawns—and target of highest pesticide use—is growth of weeds, such as dandelions (*Taraxacum officinale*) or crabgrass (*Digitaria* spp.). Presence of weeds is a symptom of a lawn undergoing stress—a common occurrence on school lawns and athletic fields. Lawn stress can contribute to the development of insect and disease problems as well.

Sources of stress include levels of use unsuited to the grass species that has been planted, compacted soils, improper mowing heights, too much or too little irrigation or fertilization, accumulation of thatch, and uneven grading.

Knowing the identity of the pest and something about its biology often reveals the specific source of stress. By relieving the stress, the pest problem can be reduced or eliminated. For example, the weed yellow nutsedge (*Cyperus esculentus*) grows best in waterlogged soils—indicating a faulty or broken irrigation valve or a low spot in the lawn. The presence of chinch bug (*Blissus* spp.) damage, on the other hand, indicates drought stress, while brown patch disease, caused by the fungus *Rhizoctonia solani*, suggests excessive fertilization with soluble nitrate fertilizers.

### **Reducing Stress on Lawns**

The best method for reducing stress on lawns is to employ good horticultural practices during lawn installation and maintenance. Even where budgets are limited, key sources of stress can be avoided or diminished by minor changes in maintenance practices, such as raising the mowing height or changing fertilizer formulations. The following lawn care suggestions will help keep pest problems to a minimum.

### **Maintaining Healthy Soil**

The most vigorous lawn growth occurs in loose, loamy soils teeming with beneficial microorganisms, insects, worms, and other organisms. These organisms play critical roles in transforming thatch and grass clippings into humus. Humus slowly releases nutrients and buffers grass roots from extremes of drought or other stresses. Soil organisms also play an important role in biological pest control. For example, certain beneficial microorgan-

isms protect lawn roots from attack by soil pathogens or insects such as white grubs.

The presence of humus in the soil is key to a healthy soil ecosystem. The best way to improve poor soils and maintain healthy soils is to insure that organic matter is routinely replenished by leaving grass clippings to decompose, and fertilizing or topdressing with organic materials such as sludge, composted manure, etc.

### **Planting Appropriate Grass Species**

School lawns are subject to high levels of use and wear, and maintenance budgets are usually low. Thus, select blends of grass species tolerant to such conditions and resistant to local pest problems. Check with the Cooperative Extension Service closest to your school for recommendations suited to local climate and conditions. In temperate areas of the country, a seed mix favored by many schools is 80% fine bladed tall fescue (*Festuca arundinacea*) and 20% perennial ryegrass (*Lolium perenne*). This mix is highly tolerant of drought, wear, and low fertility. Depending on the varieties of tall fescue or perennial ryegrass selected, the mix is also resistant to certain pest species.

‘Mustang’ tall fescue is resistant to the turf diseases brown patch and melting out. Many tall fescue grasses also release chemicals into the soil that prevent competition from lawn weeds such as crabgrass and purslane. In southern and western states where sub-tropical grasses are grown, centipedegrass and ‘Floritam’ St. Augustinegrass are resistant to chinch bugs.

### **Reducing Soil Compaction**

When lawns are heavily used, or simply mowed on a regular basis, the soil eventually becomes compacted, and the pore spaces that allow water and air to pass through the soil become compressed, creating adverse conditions for root growth. Compaction can be reduced through aeration, topdressing, and rotation of mowing patterns.

Aeration involves removing plugs of grass to improve air exchange and water penetration into the soil. Ideally, heavily used turf should be aerated two to four times per year, although even a single aeration is better than none. Since aerating can provide a seedbed for problem weeds, you should time aeration operations to avoid periods when heavy seeders such as crabgrass are germinating or setting seed.

Follow aeration with a topdressing of composted sludge along with seeds of the desired lawn grass.

---

Drag the lawn with a piece of cyclone fencing to break up cores of soil left by the aerator and to fill in holes with the topdressing material.

Mowers and other maintenance equipment compact the soil. By rotating the point of mower entry onto the lawn from week to week, compaction at entry points can be minimized.

### **Raising the Mowing Height**

Most temperate grasses used on school lawns (tall fescues, perennial ryes, bluegrasses, etc.) can be mowed at a height of 2 1/2 to 3 inches without sacrificing vigor or function as ball fields or recreational areas. Similarly, subtropical grasses such as St. Augustinegrass or centipedegrass can be mowed at 1 to 1 1/2 inches. The taller the grass can be kept and the denser the canopy, the greater the interception of available sunlight. By keeping the soil shaded, weed seeds are less likely to germinate.

Adjust mowing frequency to changes in the growing season. Weekly intervals may be appropriate when grasses are growing vigorously, but when grasses are semi-dormant, 14 or 21 days may be more appropriate. The right interval between mowings allows grasses to recover from the previous cut and enter the second growth phase when new blades, called tillers, are produced from the growing points. “Tillering” keeps lawns growing in a tight, dense manner that discourages weeds.

### **Careful Irrigation**

Too much or too little water stimulates pest problems. For example, many lawn diseases result from excessive irrigation. Development of a disease can often be arrested by letting the lawn dry out, then keeping irrigation to a minimum.

The length of time needed to adequately water lawns is determined by the time it takes to wet it to the depth of the root system. Most lawn grass roots extend 4 to 6 inches in the soil, but because grasses and soil conditions differ, irrigation schedules must be tailored to individual lawns and adjusted for seasonal changes. Infrequent, deep irrigation is preferred since frequent, shallow watering promotes shallow rooting. Use a soil probe or a pointed tool such as a screwdriver to determine when soil is wet 4 to 6 inches below the soil. This will indicate how long to leave sprinklers on at each irrigation.

Irrigation equipment should be checked to insure that

it is in good repair and that all areas of lawn receive adequate coverage. Low spots should be leveled or drained to avoid waterlogged soils that favor weeds and pathogens.

### **Keeping Thatch to a Minimum**

Thatch is the accumulation of dead but undecomposed roots and stems that collects in a layer at the soil surface. If the thatch becomes excessively deep—greater than 3/4 inch—water and nutrients do not penetrate the soil adequately. When water puddles on thatch, it enhances the habitat for disease organisms. Regular aeration keeps thatch at an acceptable level, and the use of organic fertilizers such as composted sewage sludge promotes thatch decomposition. Synthetic chemical fertilizers, on the other hand, actually enhance thatch development. Excessive layers of thatch can also be removed with de-thatching rakes, or with power de-thatchers available from equipment rental companies.

It is wise to seed the area with desired grasses wherever lawns are thinned by de-thatching procedures. The seeds can be mixed into the topdressing (soil amendments or organic fertilizer) that is customarily applied to thinned lawns. The grass seedlings usually out-compete weeds that attempt to occupy the openings.

### **Fertilizing with Restraint**

Excessive nitrogen fertilizer produces weak grass blades with thin cell walls that are susceptible to pest attack. A soil test should be obtained before planning annual fertilization programs. Only the levels of nutrients needed should be applied. Split applications (one in spring, one in fall) should be used, rather than a heavy single application in the spring. Use slow-release fertilizer to prolong the availability of nutrients throughout the growing season. When feasible, organic fertilizers such as sludge or compost are preferable because they provide organic matter to support soil microorganisms and improve soil health.

Fertilization can be used to directly suppress weeds and lawn pathogens. A study by Ohio Extension Service researchers in the 1940s showed that an application of 20 lbs. of composted poultry manure per 1000 ft<sup>2</sup> of lawn in late fall and early spring stimulated early spring growth of lawn grasses, enabling them to crowd out crabgrass. In this study, crabgrass was reduced by up to 75% within one year.

---

A recent study by Cornell University researchers (Hummel and Thurn 1992) showed that monthly applications of Sustane<sup>®</sup>, a composted turkey litter (NPK 5-2-0), at a rate of 1 pound of actual nitrogen per 1000 sq. ft., suppressed pink and gray snow mold (*Microdochium* spp. and *Typhula incarnata*, respectively), summer patch (*Magnaporthe poae*), dollar spot (*Lanzia* spp.), and brown patch (*Rhizoctonia solani*).

### Direct Pest Suppression

When the horticultural methods listed above are not sufficient to solve the pest problem, direct suppression

methods including physical, biological, and chemical controls can be integrated into the program.

Physical controls include using a flamer to spot-treat weeds, or using a bamboo pole to flick off dew from grass blades in the early morning to deny nourishment to lawn pathogens. Biological controls include applying microscopic insect-attacking nematodes to kill soil-dwelling white grubs, or topdressing lawns with microbially enhanced soil amendments to kill lawn pathogens. Chemical controls include insecticidal oils, insecticidal and herbicidal soaps, botanical insecticides such as neem oil, and pyrethrin.

## Chinch Bugs

Chinch bugs (*Blissus* spp.) are the most important of the “true bugs” (order Hemiptera) that become pests on lawns. Several species of chinch bug are serious pests of a variety of lawn grasses. The southern chinch bug (*B. insularis*), prevalent in the warm climates of the southeast, south, and parts of the west, feeds primarily on St. Augustinegrass, but it also feeds on bermudagrass and zoysiagrass. The hairy chinch bug (*B. hirtus*), a pest in the northeast, particularly from New Jersey to Ohio, feeds on bentgrasses, bluegrass, and red fescue.

### IDENTIFICATION AND BIOLOGY

Adult chinch bugs overwinter in dry grass and other debris that offers them protection. In spring or early summer, depending on temperature and moisture, overwintering females lay from 200 to 300 eggs on leaves of grass, or push them into soft soil and other protected places. Young nymphs (the immature stages) emerging from the eggs are bright red with a distinct white band across the back. The red changes to orange, orange-brown, and then to black as the nymph goes through five growth stages.

Nymphs range from about 1/20-inch long soon after hatching to nearly the size of the 1/4-inch long adult. The nymphs mature into adults, which are black with a white spot on the back between the wing pads. The adult stage of the southern chinch bug can live 70 days or more; hairy chinch bug adults live only 8 to 10 days. Adult southern chinch bugs tend to move by walking, whereas hairy chinch bug adults fly. In the spring, adults can be seen flying to new areas.

The development time of eggs, nymphs, and adults is directly dependent upon temperature, and thus varies from one part of the country to another. Development of one generation, from egg to adult, can take six weeks at

83°F and 17 weeks at 70°F. Chinch bugs produce up to seven generations per year in southern Florida, but only three to four generations in northern Florida, two generations in Ohio, and one in New Jersey.

### DAMAGE

Chinch bugs suck the juices from grass leaves through their needle-like mouthparts. They also inject a toxic saliva into the plant that disrupts the plant's water-conducting system, causing it to wilt and die. Most damage is caused by nymphs that concentrate in limited areas together with the adults and feed on the same plants until all the available juice has been extracted from the grass. This feeding pattern results in circular patches of damaged grass that turn yellow and then brown as they die. In the yellow stage, the grass superficially resembles grass that is drought-stressed. As it dies, the chinch bugs work outward from the center of the infestation, destroying a larger area as they advance.

Populations of chinch bugs increase under hot, dry conditions. In wet, cool years, or when lawns are kept properly irrigated and not over-fertilized, the chinch bug populations decrease significantly.

### DETECTION AND MONITORING

Lawns can be protected from damage by chinch bugs through regular monitoring. The objective is to detect pests while their populations are still small and determine whether their natural controls—such as adverse weather, other insects, and diseases—will keep the population low enough to prevent damage.

Any lawn can tolerate a low population of chinch bugs and most other pests without sustaining significant damage. If the monitoring techniques described below

## Box 10-C. How To Count Chinch Bugs

### Flotation Method

If you see damage that you suspect has been caused by chinch bugs but you cannot see the bugs themselves, try the flotation method. Cut the ends off a 2-lb. coffee can, then push one end of the can a few inches into the sod. If this is difficult, use a knife to cut the ground around the perimeter of the can. Fill the can with water; if it recedes, fill it again. If chinch bugs are present, they will float to the surface in 5 to 10 minutes.

If you are monitoring before you have seen any sign of chinch bug damage, the flotation method should be used in four or five random locations around the lawn. If damage has already occurred and you are trying to diagnose the cause, place the can at the edge of the damaged area to detect nymphs that have moved to the perimeter of the damage to feed on fresh grass.

### Soap-and-Flannel-Trap Method

Put 1 fluid oz. of dishwashing soap in a 2-gal. sprinkling can and drench a 2 ft<sup>2</sup> area of lawn where you suspect there are chinch bugs. Watch the area for two or three minutes. Larger areas can be covered by putting the detergent in a hose attachment designed to hold pesticides for spraying the lawn. If chinch bugs are present, they will crawl to the surface of the grass.

Next, lay a piece of white cloth, such as an old bedsheet or a piece of white flannel, over the area treated with the soapy water. Wait 15 to 20 minutes, then look under the cloth to see if chinch bugs have crawled onto it as they attempt to escape the soap. Their feet tend to get caught in the flannel's nap. Pick up the cloth and either vacuum it or rinse it off in a bucket of soapy water to remove the bugs. The vacuum bag should be disposed of so that the bugs will not return to the lawn.

This method can also be used to monitor for other insects such as lawn caterpillars, mole crickets, and beneficial insects that feed above the soil, but it will not bring soil-inhabiting grubs or pillbugs to the surface.

indicate that there are fewer than 10 to 15 chinch bugs per square foot, generally no action is needed.

It is a good idea to begin monitoring as early as mid-April in south Florida, mid-May in Ohio, and early June in New Jersey, before overwintering adults have finished laying their spring eggs. A quick check of the lawn once a month during September should be sufficient in most areas.

Chinch bugs produce an offensive odor that advertises their presence, especially when populations are high or when they are crushed by foot traffic. Since nymphs tend to congregate in groups, it is important to check several areas of the lawn. Infestations often begin on the edges of lawns, particularly in sunny, dry spots, so check these areas carefully. Spread the grass apart with your hands and search the soil surface for reddish nymphs or black adults. Chinch bugs may also be seen on the tips of grass blades, where they climb during the day. Be certain to distinguish between the pest chinch bugs and their predators, the big-eyed bugs, which they superficially resemble. Box 10-C describes two methods of counting chinch bugs.

## MANAGEMENT OPTIONS

### Physical Controls

#### Chinch Bug-Resistant Grass Cultivars

If chinch bugs are a chronic problem, it may be advisable to replace existing grass with a type that is resistant to chinch bugs. In southern states, centipedegrass or the St. Augustinegrass variety 'Floritam,' are not attacked by chinch bugs. In other parts of the country, try perennial ryegrass varieties such as 'Repell,' 'Score,' 'Pennfine,' and 'Manhattan' or Kentucky bluegrass varieties such as 'Baron' and 'Newport.'

#### Habitat Management

Chinch bugs are attracted to lawns that have an excessive buildup of thatch, are insufficiently irrigated (often due to soil compaction), or have either too little nitrogen or too much in a highly soluble form that forces grass to grow too rapidly. The discussion of good lawn culture provided at the beginning of this chapter includes suggestions on overcoming these problems. Proper habitat management will go a long way toward controlling these bugs.

#### Manual Removal

Small populations of chinch bugs can be removed from the lawn using the soap solution and white flannel cloth method described in Box 10-C. This is particularly appropriate when damage is just beginning to appear, since at this stage chinch bug nymphs are still congregated in specific locations and can be collected efficiently. Small vacuums may also be helpful.

#### Biological Controls

One of the primary tactics for the biological control of chinch bugs is conserving its natural enemies. At least

---

two beneficial organisms often move in to feed on chinch bugs: the big-eyed bug and a tiny wasp. The big-eyed bug (*Geocoris* spp.) superficially resembles a chinch bug, so pest managers must learn to distinguish between the two. According to Ohio State University turf specialist Harry Niemczyk, “the body of the chinch bug is narrow, the head small, pointed, triangular-shaped, with small eyes, while the body of the big-eyed bug is wider, the head larger, blunt, with two large prominent eyes. Big-eyed bugs run quickly over the turf surface and are much more active insects than the slower-moving chinch bugs.”

Although big-eyed bugs cannot be purchased from insectaries at this writing, recent research indicates that members of this genus can be reared easily and inexpensively, so they may become commercially available in the near future.

The tiny wasp *Eumicrosoma beneficum* can parasitize

up to 50% of chinch bug eggs under favorable conditions. It should be noted that common insecticides such as chlorpyrifos and herbicides such as simazine significantly reduce populations of these biological control organisms in lawns, thus triggering repeated pest outbreaks.

### **Chemical Controls**

If non-chemical methods alone prove insufficient to solve the problem, then integrating a pesticide into your management program may be warranted. For information on the hazards of various pesticides and on how to select an appropriate pesticide for your situation, consult Appendix G for a list of resources.

If pesticide use seems necessary to bring a serious chinch bug infestation under control, insecticidal soap or pyrethrin should be considered.

Many schools throughout the U.S. have planted lawns of

## **Fusarium Blight**

Kentucky bluegrass, a species that is particularly susceptible to a disease called fusarium blight, caused by the fungus *Fusarium culmorum*.

### **IDENTIFICATION AND BIOLOGY**

Infected turf has small, circular, 2-inch spots of dead and dying grass that often enlarge to 24 inches in diameter. Spots begin as dark blue to purple wilted turf and turn straw-colored to light tan when dead. The grass in the center of each spot may remain healthy and become surrounded by a band of dead turf—a symptom called “frog eye.” Both the leaf blades and the basal crown may be affected.

Fusarium blight is a warm-weather disease that can occur from late June through early September, depending on the location. It usually appears after a week or two of dry weather following a heavy rain and is associated with shallow-rooted grass, which is highly vulnerable to drought stress. Symptoms often appear first along sidewalks and in poorly drained areas. The disease primarily attacks Kentucky bluegrass when it is kept in a lush, over fertilized state in summer. Kentucky bluegrass varieties ‘Park,’ ‘Campus,’ ‘Fylking,’ and ‘Nuggett’ are particularly vulnerable. Annual bluegrass and fine-leaf fescues are also affected.

### **MANAGEMENT OPTIONS**

#### **Physical Controls**

##### **Planting Resistant Grasses**

Consider modifying or replacing highly susceptible Kentucky bluegrass lawns with a mix of species such as tall fescues and perennial ryegrasses or, in subtropical climates, bermudagrass or St. Augustinegrass. ‘Columbia’ is one bluegrass variety that is resistant to fusarium blight.

The increased drought- and heat-tolerance of perennial ryegrass, tall fescue, and other varieties is one of the factors thought to explain the suppression of disease. Simply adding 10 to 15% of these other grasses to a Kentucky bluegrass lawn can greatly reduce the incidence of fusarium blight. The County Cooperative Extension Service can provide information on cultivars that grow well in your area.

##### **Fertility Management**

Kentucky bluegrass naturally slows its growth during warm summer months because it does not tolerate high temperatures well. It is important not to over fertilize. Excessive nitrogen produces lush, soft growth more vulnerable to attack by the disease. A moderate but balanced fertilizing program should be maintained so that

---

the lawn can produce growth to cover damage. Slow-release fertilizers, especially composted sludge or manure, is desirable. The highly soluble fast-release nitrogen fertilizers should be avoided.

### **Aeration**

Fusarium blight is exacerbated by compacted soils, excessive thatch, and soil layering, all of which inhibit the percolation (seeping) of water into the soil.

Diseased turf should be aerated with a coring tool (see the discussion at the beginning of the chapter under Reducing Soil Compaction) to reduce compaction and thatch and increase infiltration and soil air movement. Coring also helps integrate the dissimilar soil layers that occur when imported topsoil or sod is used to establish the lawn. When one soil type is laid on top of another, water tends to collect at the boundary, moving laterally rather than vertically. Grass roots tend to stop growing when they reach this boundary, and can die in the excessively wet soil. By coring into the layered soil and incorporating compost, both water and roots are encouraged to move more deeply into the soil, producing more vigorous growth.

### **Water Management**

Supplemental irrigation will help drought-stressed grasses outgrow fusarium blight. It may be necessary to irrigate daily at the hottest times of the day until the grass resumes vigorous growth. Thatch management and removal of infested grass blades after mowing are also effective controls.

### **Biological Controls**

Because fusarium blight primarily attacks roots, the more you can do to increase the number of beneficial microbes in the soil that are antagonistic to the pathogens, the fewer problems you will have.

Studies (Vargas et al. 1989) have shown that a number of products on the market can do just that and thus can help a lawn recover from the necrotic ring spots associated with fusarium blight. Researchers tested these products on lawns with ring spots and found that after 3 years all treated lawns had recovered 100% whereas the number of ring spots on untreated lawns had increased by 300%. The products tested were the following:

- Soil Aid®—contains an enzymatic wetting agent that helps to flush substances that are toxic to beneficial soil

microbes out of the soil and the thatch

- Green Magic®—contains a variety of soil nutrients, beneficial microbes, and various plant extracts
- Strengthen & Renew®—contains the same kinds of ingredients as Green Magic
- Lawn Restore®—a fertilizer that consists of bone meal, feather meal, soybean meal, and other protein sources supplemented with beneficial microbes.

All the products were applied twice in the summer and once in the fall at a rate of 1-lb per 100 square feet. Soil Aid was used along with either Green Magic or Strengthen & Renew. Lawn Restore was used alone.

The researchers stress the importance of frequent treatment when using biological approaches to managing lawn diseases, “These products are not like fungicides that can be applied one time, halting the spread of the fungus and allowing the grass to recover. In order to be effective, such products must be applied on a regular basis, either monthly or bi-monthly throughout the growing season to change the biological makeup of the thatch and soil environment.”

### **Chemical Controls**

If non-chemical methods alone prove insufficient to solve the problem, then integrating a pesticide into your management program may be warranted. For information on the hazards of various pesticides and on how to select an appropriate pesticide for your situation, consult Appendix G for a list of resources.

The Cooperative Extension Service should be consulted for information on fungicides registered for use against this pathogen.

### **BIBLIOGRAPHY**

- Ali, A.D. and C. L. Elmore. 1992. Turfgrass Pests. Cooperative Extension, ANR Publication 4053. University of California, Oakland, CA. 121 pp.
- Bio-Integral Resource Center (BIRC). 1996. 1997 directory of least-toxic pest control products. IPM Practitioner 18(11/12):1-39.
- Couch, H.B. 1973. Diseases of Turfgrass. Krieger Pub. Co., Huntington, NY. 248 pp.
- Hummel, N.W. Jr., and M. Thurn. 1992. Turfgrass IPM demonstration, pp. 52-53. In: Anon., 1991 Reports: IPM research, development, and implementation projects. Ornamentals. New York State IPM Program. IPM Publication 404. Cornell University, Ithaca, NY.

- 
- Madison, J.H. 1971. *Practical Turfgrass Management*. Nostrand Reinhold, New York. 466 pp.
- Niemczyk, H. 1981. *Destructive Turf Insects*. HDC Book Sales, Wooster, OH. 48 pp. [Available from 2935 Smithville Western Rd., Wooster, OH 44691.]
- Olkowski, W., S. Daar, and H. Olkowski. 1991. *Common-Sense Pest Control: Least-toxic solutions for your home, garden, pets and community*. Taunton Press, Newtown, CT. 715 pp.
- Schultz, W. 1989. *The Chemical-Free Lawn*. Rodale Press, Emmaus, PA. 194 pp.
- Tashiro, H. 1987. *Turfgrass Insects of the United States and Canada*. Cornell Univ. Press, Ithaca, NY. 391 pp.
- Vargas, J.M., Jr., D. Roberts, T.K. Dannenberger, M. Otto, and R. Detweiler. 1989. Biological management of turfgrass pests and the use of prediction models for more accurate pesticide applications, pp 121-126. In: *Integrated Pest Management for Turfgrasses and Ornamentals*. A.R. Leslie and R.L. Metcalf (eds.), U.S. Environmental Protection Agency, Washington, D.C.



---

# CHAPTER 11

## IPM FOR HEAD LICE IN SCHOOLS

### INTRODUCTION

Today, the management of head lice continues to be a major task for parents, school personnel, and health care professionals worldwide. The growing resistance of lice to pediculicides (lice-killing insecticides), combined with a surprising willingness of many parents to tolerate head lice, is turning a manageable problem into a major nuisance.

Head lice are most often found on school children between the ages of three and ten, less often on older children or adults. The eggs, or nits, of head lice are glued tightly to hairs, most often around the back of the ears and at the nape of the neck. The adults are found in these and other areas of the head, including the eyelashes, and more rarely on other body hairs.

The traditional chemical “first-strike” approach is inappropriate and is not recommended. The chemicals used in lice shampoos may pose long-term health hazards and under no circumstances should they be used on pregnant or nursing women or children under two. Sound management of head lice involves prompt diagnosis and the use of non-toxic physical treatments, with insecticides only as a last resort. Each of these elements requires that the person treating the lice problem have more precise information about the biology of lice than is usually available.

### IDENTIFICATION AND BIOLOGY

The head louse, *Pediculus humanus capitis*, is one of three sucking-lice species that feed on humans. The head louse spends its entire life on the human head; if it does move onto other surfaces, it must return to the head within a few hours to survive. Lice can survive only 24 hours without blood and they cannot complete their life cycle on pets.

Head lice can move fairly rapidly, but cannot jump or fly. The adult head louse is 1/16 inch to 1/8 inch long, and ranges from tan to grayish-white in color. Each of its six legs ends in a claw that is used to grasp the hair shaft. The nits are laid near the junction of the scalp and the hair shaft. The eggs are oval-shaped and are attached to the hair with a very tough glue. Each female produces about 6 to 8 eggs in a 24-hour period and these are laid mostly at night.

The eggs hatch within 7 to 11 days. Once hatched, developing lice take 8 or 9 days to become adults; after an additional day, the adult female can start laying eggs. Thus, about 16 days in all are required for an egg to give rise to a female capable of laying more eggs. Adults live for up to 30 days.

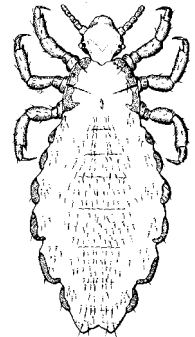

Head Louse

### HOW LICE ARE TRANSMITTED

Most head lice are probably transmitted when an infested person comes into close contact with another. For example, when children sleep or sit together, enough time and opportunity is provided for a louse to walk from head to head. Lice and their eggs can also be transferred between people via infested brushes, combs, caps, hats, scarves, coats, bedding, towels, and upholstered furniture.

### DAMAGE

Although the symptoms of head lice are irritating, head lice have generally been regarded as little more than a nuisance by medical personnel. While a louse bite itself is painless, the louse’s saliva usually causes an allergic reaction that produces itching (although some people may not experience the itching for several weeks). If itching is severe, the lice probably have been present for some weeks. Scratching that breaks the skin creates entryways for germs and lice feces, and can lead to swollen glands and secondary infections such as impetigo. Severely infected individuals may experience fever and feel tired and irritable.

### DETECTION AND MONITORING

Frequent head scratching may be the first sign of lice. Adult lice may be present on the head or in the eyebrows and eyelashes, and with careful observation the eggs can be seen. A magnifying glass will help in distinguishing between nits and dandruff. Eggs are oval-shaped and attached only to one side of the hair shaft. The eggs themselves stay glued to the hair even after they hatch, and cannot be removed as easily as a piece of dandruff or other debris. Because eggs stay

---

attached to the hair, it is also important to determine whether or not the egg has hatched. Nits start out as a yellowish to gray color and darken to a tan or coffee color before they hatch. Hatched eggs are white. Eggs that are shrunken or indented will not hatch.

Originally, scientists believed that eggs that were 1/4 inch or more away from the scalp would all be hatched or dead, and therefore it wasn't necessary to examine eggs that might be farther down the hair shaft. Recent research (Taplin and Meinking 1988) shows that this is not always true, particularly in warmer climates and possibly on individuals who always wear some type of head covering.

## MANAGEMENT OPTIONS

Lice can be controlled without resorting to shampoos with pesticide, but this depends on thorough combing of the hair with a special lice comb. Because reinfestation from playmates is common (regardless of the treatment used), parents may wrongly assume that the first treatment wasn't strong enough and turn to something more toxic. To minimize reinfestation, schools are urged to adopt a "No Nit" policy (see below) and to educate teachers and students, but especially parents, in how to find, control, and prevent head lice.

### Education

Most people view lice with disgust. Panicked parents who would not normally expose their children to potentially hazardous materials will apply pesticides in haste, sometimes well beyond the recommended frequency and dosages. Education can help to overcome these obstacles to non-toxic lice control.

It is crucial that teachers, children, and parents have some rudimentary information about head lice before a lice outbreak occurs. The school can send an information sheet home with children when school begins in the fall and after long vacations. The sheet can include some facts about lice and information on how to detect them (see Appendix H for a sample).

Encourage parents to look for head lice weekly as just another part of personal hygiene. Have teachers in the lower grades talk to students about head lice at the beginning of the school year. Young children generally are not hesitant to talk about head lice—for them it's just another learning experience. Remind them repeatedly not to share combs, brushes, caps, hats, scarves, head pieces from costumes, etc.

When an outbreak occurs, the school can send home a

packet that includes information on how to control lice and a note alerting parents that children will not be allowed back into school until their hair is free of nits—the "No Nit" policy (see below). See Appendix H for a sample information packet.

It is our experience that sometimes only a small group of families is responsible for the frequent reinfestation of an entire class. It is important to understand that there are some parents who do not regard head lice as a serious problem at all. Many cultures outside the United States accept head lice as a minor, constant inconvenience, and do not assume that head lice can be eliminated when infestations occur. Families with this attitude may need to be convinced of the importance of cooperation.

### "No Nit" Policy

The National Pediculosis Association (P.O. Box 610189, Newton, MA 02161; 617/449-NITS), a non-profit organization that provides education on safe ways to manage head lice, recommends that schools establish a "No Nit" policy, which means that children are denied re-admission to the classroom until their heads are free of lice eggs. This recommendation is based on the fact that most parents and teachers cannot easily tell the difference between an egg that is viable and one already hatched. By tolerating nits, children are allowed to return to school and unwittingly spread head lice to others.

When a "No Nit" policy is adopted, each principal should designate at least one member of the school staff to receive training from the school nurse or other public health official in the detection of lice and nits.

### Store Garments Separately

Transmission can be reduced through proper storage of hats and other garments that may carry stray female lice. Head lice are a particular problem among children in child care programs, kindergarten, and the early grades of grammar school. Facilities should be equipped with separate lockers or "cubbies" for each child. Headgear, scarves, and other outer clothing that comes into contact with the hair should be stored separately, one cubbyhole for each child. It is crucial that the parent or teacher explain the importance of this behavior clearly. If separate lockers or cubbies are impossible, cloth bags that close at the top with a drawstring are another alternative. At the very least, children should be assigned a hook on the wall to use throughout the school year. There is evidence that assigned hooks can reduce the spread of lice through a classroom.

---

If, during head lice outbreaks, cubbies or lockers are unavailable, sturdy plastic bags can be used. Place identifying decals on individual bags so children know which is theirs. Bags containing clothing should be doubled over and wrapped with a twist tie. This process should be supervised to make sure the children are doing it properly. Torn bags should be replaced immediately.

### **Housekeeping**

The rugs and upholstered furniture in classrooms with lice outbreaks should be thoroughly vacuumed. If lost and found articles are stored in the classroom, they can be separated by placing them in individual plastic bags, and then sealed.

### **Treatments**

This must be left to the parents, but the school can provide them with accurate information on how to comb for lice and nits, and on the hazards and proper use of insecticidal shampoos. The Sample Information Packet in Appendix H provides this information.

### **Physical Controls**

It is possible to eliminate a lice problem using the following physical controls without resorting to more toxic chemicals. Success depends on several factors, including the determination of parents, existence of good relations between the parent and child, and the length and texture of the child's hair.

### **Combing**

Combing is the most important aspect of head lice control. Combing removes nits from the hair and helps you to find adult lice. Unfortunately, there is no safe solvent for the powerful glue that holds the nits to the hair, and though insecticides may kill some eggs, they do not kill them all. Box 11-A provides detailed instructions on combing that should be followed carefully using a comb with specially tooled metal teeth designed to remove head lice and their eggs from the hair. Metal lice combs are available from pharmacists. Ordinary fine-toothed plastic combs are not adequate, even though they may be sold along with various insecticides for the control of head lice.

There is no denying that the combing process demands time and patience from parents and children; however, many parents tell us that their children grow to enjoy the process and even look forward to it because it feels good and the child is the center of the parent's attention.

Based on the life cycle of the female head louse, and assuming the child is not immediately reinfested, the

combing process should be repeated every 5 to 7 days during the period when head lice are a problem at the school. If the child becomes reinfested before a week has elapsed, the combing will have to be repeated sooner. Parents should refrain from using pesticides with these cases of immediate reinfestation; instead, use only the combing method to remove lice and nits.

### **Salad Oil**

The use of salad oil is sometimes recommended to smother adult lice, but personal experience has shown us that lice can survive in hair covered with oil even when it is left on overnight. Do not count on oil to kill adults or nits. Oil can be very useful in combing, however. Oil prevents the hair from tangling which makes combing much easier. In this respect, oil works better than shampoo or conditioner and doesn't dry out during the combing process. Washing the hair twice with any ordinary shampoo will remove all traces of the oil.

### **Laundering and Vacuuming**

Lice *may* wander from the head to areas such as bedding, headwear, furniture, or rugs, but in general, head lice do not leave the head and there is no need to go into a frenzy of laundering and cleaning. The time and energy spent in washing clothes and cleaning the home environment would be far better spent combing out nits, and educating the child and other parents, teachers, and children with whom the child associates. If hairs with nits fall off the head, it is possible for the nits to hatch, but the immature lice can live for only a very brief period without returning to the head to feed.

If items must be washed, putting the clothing or bedding through a wash cycle with ordinary detergent in a washing machine and then drying in a dryer is sufficient. Vacuuming is just as efficient as washing at removing stray nits and wandering lice. Clothing, pillows, upholstered furniture, and rugs can all be vacuumed.

### **Chemical Controls**

#### **Ordinary shampoo**

Certain fatty acids in soaps have insecticidal properties, but shampoos are detergents, and you cannot count on shampoo to kill young or adult lice. Although it might seem possible to drown lice while shampooing the hair, personal experience has shown us that adult lice can survive through two consecutive shampooings even when the hair is not rinsed for an hour after the second shampooing.

## Box 11-A How to Comb for Head Lice

NOTE: We do not recommend shampooing with a lice shampoo that contains a pesticide except in extreme cases and as a last resort.

### A. You will need:

- Salad oil.
- A special metal lice comb. These are available in drugstores (ask your pharmacist to order one if you cannot find a metal comb). **Do not** use the plastic combs that are included in some lice treatment packages. These are not effective.
- A wide bowl of water with a squirt of dishwashing detergent added. This water is used to kill nits (eggs) and lice combed from the head.
- A box of facial tissue.
- A strong lamp with a flexible arm that allows you to rotate it to direct the light wherever you are working. (If it is possible to do the combing in the daylight near a window, it will be much easier to see the adult lice and the nits.)
- If the hair is long, many large bobby pins or hair clips, to pin up sections of hair that have been combed.
- A large towel to place around the child's shoulders during combing.
- Two comfortable seats, one for the child and one for you. You want the child to be just below your eye level.
- Something entertaining for the child to do that does not require much physical activity, such as reading, drawing, playing with plastic clay, or watching videos.
- If the child has very long hair, which takes more time and tries the patience of the child, two people can work together on different parts of the head.

### B. Preparing the Hair

Cover the child's hair with salad oil (any kind will do). This will prevent the hair from tangling and make it very easy to use the lice comb. (The oil may also smother some of the young and adult lice, but you cannot count on it.) Oil has the advantage of not drying out if the combing takes a long time. After you finish combing, shampoo the hair twice to remove the oil.

### C. The Combing

1. Seat the child so that his or her head is just slightly below your eye level.
2. Brush or comb the hair (use a large-toothed regular comb) to remove snarls.
3. Separate a mass of hair that is slightly wider than the width of your lice comb and about 1/2 to 3/4 inch in the other direction. Separating the hair into such small sections is important so that you can more easily see nits and adult lice.
4. Hold the mass of hair with one hand. With the other hand, hold the lice comb in a slanting position with the curved side of the teeth toward the head.
5. Insert the comb into the hair as close to the scalp as possible, since the eggs are first laid within 1/2 inch of the scalp. Pull the comb slowly through the hair several times.
6. Comb one section at a time and check each section to make sure it is clean, then pin it out of the way, curling it flat against the head.
7. Whenever you comb out nits or live lice, dunk the comb in the

soapy water. Make sure the lice and nits are off the comb before you use it on the hair again. Frequently remove the hair and other debris from the comb with a tissue. When the tissue becomes soiled, place it in the bowl of soapy water. When the bowl is full, flush its contents down the toilet and refill the bowl with soapy water.

8. When all the hair has been combed, wash out the oil by shampooing twice.
9. Once the hair is completely dry, check the entire head for stray nits and remove those hairs individually with a pair of small, pointed scissors (like nail scissors).

### D. Cleaning up

1. Soak the lice comb in hot ammonia water (1 teaspoon of ammonia in two cups of hot water) for 15 minutes. Metal combs can also be boiled in plain water for 15 minutes. A comb cleaned either way can be reused by many different children.
2. Scrub the teeth of the comb with a nail brush or an old toothbrush to remove debris. Remove dirt lodged between the teeth of the comb with dental floss or a small stiff brush.
3. Boil the towels for 10 minutes or wash them in a washing machine in soapy water, and follow with a hot dryer.

Note: There is no safe solvent for the glue that the female louse uses to attach her eggs to the hair even though there are products that make such claims. Combing is the only sure way to remove nits from hair.

WARNING: If you must use a shampoo with a pesticide,

- Do not leave the shampoo on any longer than the time specified, and do not use it more frequently than indicated on the label. Follow the directions exactly.
- Do not use on the eyebrows or allow any shampoo to get into the eyes.
- Do not use on pregnant women or nursing mothers.
- Do not use on children under 2 years.
- Do not use on anyone with open cuts or scratches or with head or neck inflammations.
- Do not use in a shower or bath where the pesticide can reach other parts of the body. Shampoo hair over a basin or sink.
- Use gloves to do the shampooing.
- Do not count on lice shampoos to kill nits. You must comb to get them out.
- Never use any head lice shampoos preventively. Before you treat, make sure that live lice or eggs are present.
- Return to combing if the lice shampoo is not working; it may mean product failure or that the lice have become resistant to the pesticide.
- Store these shampoos out of the reach of children, ideally in a locked cabinet.

---

## Shampoos with Pediculicides

We do not recommend the use of insecticides except as a last resort in extreme cases. The scalp has many blood vessels that are close to the skin, making it easy for toxic substances to be absorbed directly into the bloodstream. Absorption is greater when the skin is warm and the blood vessels are dilated.

For many years, lindane (commonly referred to as Kwell®), an organophosphate pesticide, was the treatment of choice; it is still recommended by many medical personnel who have not taken the time to acquaint themselves with its potential health hazards to humans. Lindane is absorbed through the skin into the bloodstream; once absorbed, it can be carried throughout the body to tissues and organs. In pregnant women, it can travel across the placenta to the developing fetus. Lindane is available only by prescription. We do not recommend its use at any time. In many cases, its chronic overuse has produced resistant lice and rendered lindane ineffective.

The over-the-counter pesticides include pyrethrum, pyrethrins, and permethrin. The National Pediculosis Association has been collecting numerous reports of failures of these products as well. It is unclear whether these problems are caused by product failure or lice resistance, but it is another reason to use combing as the main control method.

Pesticidal shampoos must be used in accordance with their EPA-approved label directions. Never re-treat with the chemical more frequently than the label allows. The following cautions should be added to those already on the label:

- Never treat pregnant or nursing women, infants, or children under two with pediculicides.
- Minimize body exposure. Confine the exposed area to the head hair. Do not treat the eyebrows or get the pediculicide near the eyes. Do not use in the bathtub or shower stall; use a basin or sink so pesticide residues do not reach other parts of the body. Wear rubber gloves to protect yourself if you shampoo yourself or someone else.
- Minimize frequency of use. Frequent, repeated use

of pediculicides, especially lindane, is dangerous. Never use insecticides at higher doses or at a greater frequency than listed on the label! If insecticides are not working it can mean either product failure or lice resistance. Return to combing.

- Never treat anyone with open cuts, scratches, or head or neck inflammations. Check for cuts, scratches, or inflammation before treatment; do not use insecticides if such conditions are found.
- Store insecticides out of reach of young children, ideally in a locked cabinet. Treat insecticides as you would any other poison.
- Do not use any head lice insecticide preventively. Before you undertake any treatment, make sure live head lice or viable eggs are present.

## Lice Sprays

Never, under any circumstances should lice sprays be used. Lice cannot live in the environment and lice sprays unnecessarily expose everyone to harmful pesticides.

## BIBLIOGRAPHY

- Bio-Integral Resource Center (BIRC). 1996. 1997 directory of least-toxic pest control products. *IPM Practitioner* 18(11/12):1-39.
- Olkowski, W., S. Daar, and H. Olkowski. 1991. *Common-Sense Pest Control: Least-toxic solutions for your home, garden, pets and community*. Taunton Press, Newtown, CT. 715 pp.
- Poorbaugh, J. 1990. Head lice infestation—update on control measures. *California Morbidity* 47/48:1.
- Solomon, L.M. and D.P. West. 1977. Gamma benzene hexachloride toxicity. *Arch. Dermatol.* 113:353-357.
- Taplin, D. and T.L. Meinking. 1988. *Head Lice Infestation: Biology, diagnosis, management*. University of Miami School of Medicine, Miami, FL. 31pp.
- Zinsser, H. 1934. *Rats, Lice, and History*. Little Brown, New York. 301 pp.



---

# CHAPTER 12

## IPM FOR RATS AND MICE IN SCHOOLS

### INTRODUCTION

Although setting out poison baits is the common response to rodent problems, this tactic has been overused, and strains of rats and mice have developed that are no longer affected by the poison. Even when baits remain effective, poisoned rodents frequently die in inaccessible places where their decomposing bodies create unpleasant odors and feed pest insects such as flesh flies and carpet beetles. Moreover, on school grounds, there is always a risk that children or pet animals will inadvertently come in contact with the bait.

A better approach combines careful inspection, regular monitoring, sanitation, garbage management, rodent-proofing, trapping, and, if necessary, baiting with toxicants. Unless the conditions that attracted rodents in the first place are changed, new mice and rats often move into the habitat vacated by the dead ones, and the cycle will continue.

### IDENTIFICATION AND BIOLOGY

It is important to identify which rodent species is present. Table 12-1 and Figure 12-1 describe the differences among Norway rats, roof rats, and house mice. Table 12-2 describes how to distinguish a house mouse from other similar species. After trapping a rodent, you can use information from these tables to identify it.

#### Rats

The two most common pest rat species in the United States, both introduced from Europe, are the Norway rat, *Rattus norvegicus*, and the roof rat, *Rattus rattus*. Table 12-3 summarizes the biology of these two rats. The Norway rat, considered the most important pest rat in the U.S., is also known as the brown, wharf, house, gray, or sewer rat. It occurs in every state. The roof rat, also known as the ship, black, or Alexandrine rat, occurs mainly along the coastal U.S., including the Pacific coast states, the Gulf states, and the southern and Atlantic states.

#### Characteristics of rats that can have an impact on management

- will feed on a wide variety of materials (see Table 12-4 for more specific information)

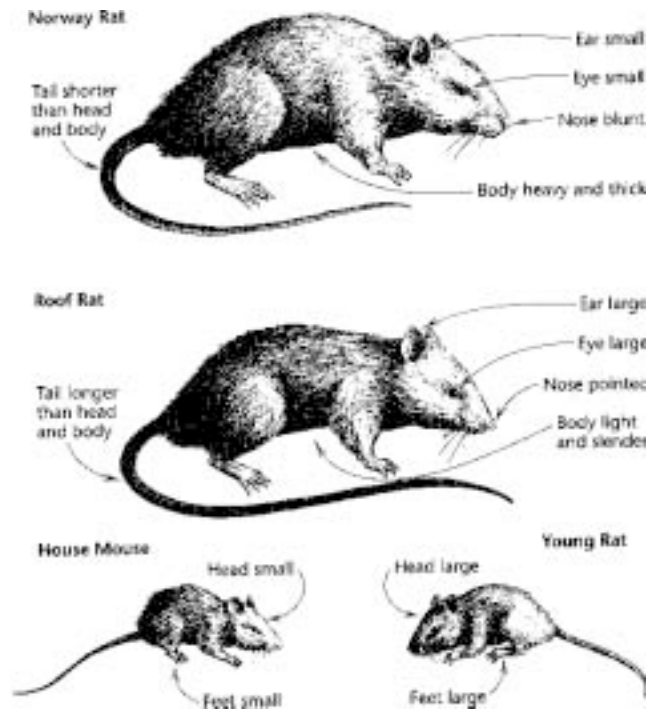

Figure 12-1.

- usually search for food between dusk and dawn, but when hungry or living under crowded conditions, may be seen in the daylight
- require water daily, unless food items are succulent
- can travel several hundred feet from their nests in search of food, depending on the relationship of food to nesting resources.
- prefer traveling along edges, e.g., the edge of the floor next to the wall, along the outside or inside of a foundation
- also travel along pipes, rafters, and for roof rats, overhead utility lines
- wary of crossing open spaces that provide no cover
- have poor visual acuity, but are quite sensitive to patterns and contrasts
- have acute senses of smell, taste, touch, and hearing; navigate using their whiskers and guard hairs
- tend to be extremely wary (though temporarily) of new objects in their environment

In general, Norway rats build their nests in underground burrows or in ground level areas in buildings

**Table 12-1.**  
**Differences Among the Norway Rat, Roof Rat, and House Mouse**

	Norway Rat	Roof Rat	House Mouse
Scientific name	<i>Rattus norvegicus</i>	<i>Rattus rattus</i>	<i>Mus musculus</i>
Other common names	brown, wharf or sewer rat	black, ship or house rat	
Adult weight	3 to 21 ounces	3 to 12 ounces	1/2 ounce
Snout	blunt	pointed	pointed
Ears	small & thick with short hairs	large & thin without hair	large, some hair
Tail coloration	dark above, pale underneath	all dark	all dark
Fur	brown with black; shaggy	light brown, gray to black; smooth	light brown to gray
Droppings	capsule-shaped, pointed	pointed & curved	rod-shaped, pointed
Food requirement	about 1 ounce/day	1 ounce or less/day	1/10 ounce/day
Water source	free water*	free water*	water from food; also need free water if dependent on a diet that is dry or high in protein
Climbing ability	can climb	active climber	good climber
Nest locations	mainly in burrows	walls, attics, trees	near/in stored material
Swimming ability	excellent	can swim	can swim

\*Water present by itself and not simply a constituent of the food eaten by the rodent. Free water unnecessary when feeding on succulent foods, but needed if diet is dry and/or high in protein.

Sources: Frantz & Davis 1991, Olkowski et al. 1991

while roof rats prefer living in elevated areas. Table 12-4 provides more specific information.

Rats have amazing physical abilities. Understanding what they can and cannot do is very important when planning ways to prevent rat problems or to reduce the number of rats present. These abilities are summarized in Box 12-A.

### Mice

The house mouse is the most common species to invade structures, but "wild" mouse species such as meadow voles and deer mice are also occasional problems, especially when temperatures drop in the autumn. Usually these mice can be easily trapped and removed, and rarely become chronic problems.

Invasions of the house mouse can occur at any time of the year, and once inside, house mice will continue to reproduce, generation after generation, without leaving the confines of the building. Biological information for the house mouse is summarized in Table 12-5, and its physical abilities are summarized in Box 12-B.

### Characteristics of mice that can have an impact on management

- can generally get all the water they need from food; if *dependent* on dry food, will need some free water
- travel over their entire home range daily (about 33 feet), investigating changes and new objects
- like rats, prefer to travel along edges and are wary of crossing open spaces
- have poor visual acuity; navigate using their whiskers
- indoors, often live in false ceilings; in appliances such as stoves, refrigerators, air conditioners, and coolers; in wall and floor voids; and in similar enclosed spaces
- outdoors, prefer thickly vegetated ground level areas

Indoors, mice populations are limited by the availability of food, by competition from other animals, and by disease. The amount of available shelter inside can limit the number of mice to a certain extent; however, in spring, summer, and fall, mice can establish themselves outdoors. They need to live inside only during the severe conditions of winter. Because rats prey on



**Table 12-2. Distinguishing the House Mouse from Other Similar Species.**

Common Name	Scientific Name	Description
House Mouse	<i>Mus musculus</i>	small feet and head in proportion to body; long ears for body size; relatively small eyes; tail nearly hairless and equal or less than the head and body combined; tail is uniformly dark
Deer Mouse or White-footed Mouse	<i>Peromyscus</i> spp	same size or slightly larger than house mouse; distinctive brown coat, pale gray to reddish brown above white belly; tail brown gray on top and white underneath with distinct line between two colors; large eyes; invades buildings near fields or wood areas
Meadow Mouse or Vole Mouse	<i>Microtus</i> spp	larger, more robust body; weighs about twice as much as the house mouse; smaller, heavily furred ears; much shorter tail; sometimes invades buildings, but commonly found outdoors under boards, boxes, etc.

Adapted from Olkowski, et al. 1991

mice and compete for the same food and shelter, removing the rats often results in higher and more visible mouse populations.

## DAMAGE

Rodents damage food, clothing, documents, and structures through gnawing, urination, defecation, and nesting activities. The damage to food from contamination is probably ten times greater than the damage by direct feeding. Feces and urine raise the humidity of enclosed spaces, promote wood deterioration, and provide a medium for proliferation of microorganisms (Frantz 1988). Rodents cause fires by chewing through the insulation on electrical wires, and they are involved in spreading human pathogens (see Table 12-6). The hantavirus is cause for concern in many parts of the country; see Box 12-C for more information.

## DETECTION AND MONITORING

Make a thorough inspection to find as many of the active infestations as possible. At the same time note all possible harborage sites, sources of food and water, and holes that provide access to the building. Box 12-D details the signs of rodent infestation, and Boxes 12-E and 12-F summarize the areas to inspect inside and out. Make detailed notes about problem areas on a map of the building. Do not neglect to inspect any outbuildings on the property.

To help you monitor effectively, do the following:

- Make a site plan of the school with separate drawings of each floor so you can accurately record information.
- Lightly dust smooth surfaces near suspected harborage, runs, or entry points with unscented talcum powder or powdered chalk to gain further information.

Footprints and drag lines (made by tails) across powdered surfaces indicate rodent traffic. The powder can also be dusted onto a heavy, smooth material such as a piece of floor tile that can be moved around. Holding a flashlight at a low angle helps to illuminate tracks on dusty surfaces.

- Inspect at night with a strong flashlight. Look for movement and listen for squeaking, scrambling, and gnawing sounds.
- Vacuum up fecal pellets and gnawed wood shavings and remove any nests. Re-inspect for new rodent signs in a day or two. In areas where hantavirus is suspected, vacuuming is not advised. See Box 12-C for precautions to take when cleaning.
- You can temporarily place a piece of gray paper or

**Table 12-3. The Biology of Norway and Roof Rats**

Breeding (estrous) cycle	polyestrous, every 4-5 days in subtropical climates, rats can reproduce year around; cooler climates, populations peak in spring & autumn
Litter size	average of 5 to 12
Litters per year	up to 9, depending on food availability (average is approx. 4 for Norway rats and 5 for roof rats)
Age at weaning	around 30 days
Gestation period	20 to 25 days
Sexual Maturity	75-90 days (Norway); 68 days (Roof)
Life span in the wild	Less than 1 year

Source: Frantz & Davis 1991

Table 12-4. Nesting and Eating Habits of Norway Rats and Roof Rats

	Norway Rats	Roof Rats
Nesting Sites Outdoors	<ul style="list-style-type: none"> <li>• in the ground, in burrows that are less than 18 inches deep and less than 3 feet long; burrow openings are 2 to 4 inches in diameter</li> <li>• burrow system can be quite complex and interconnected</li> <li>• in unused sewers or storm drains</li> </ul>	<ul style="list-style-type: none"> <li>• usually above ground: in trees, especially untrimmed palm trees; in dense, overgrown vegetation, especially Algerian ivy (<i>Hedera canariensis</i>) and in piles of wood and debris</li> <li>• in the ground if there are few suitable above-ground sites and there are no Norway rats nesting in the area</li> <li>• in unused sewers or storm drains</li> </ul>
Nesting Sites Indoors	<p>Usually in the lower floors of the building</p> <ul style="list-style-type: none"> <li>• in wall voids and crawl spaces</li> <li>• in storage rooms under pallets or equipment</li> <li>• behind seldom-used stored materials at the corners and backs of rooms</li> <li>• in any cluttered area that is little used</li> </ul>	<p>Usually in the upper part of the building</p> <ul style="list-style-type: none"> <li>• in the attic</li> <li>• in ceiling and attic voids</li> <li>• can also nest in the lower floors of a building</li> </ul>
Eating Habits	<ul style="list-style-type: none"> <li>• more likely to eat garbage than roof rats</li> <li>• prefer foods that are high in protein, such as fish, meat, nuts, grains, pet food, and insects</li> </ul>	<ul style="list-style-type: none"> <li>• rats prefer fresh plant material, such as nuts and seeds, fruit and vegetables, and tree bark</li> <li>• sometimes eat garbage and meat</li> </ul>

Sources: Meehan 1984 and Ingles 1965

cardboard in dark or hard-to-reach areas and inspect them later for fecal pellets. Remember that rats, especially Norway rats, are fearful of new things, so it may take several days before they even come near the paper. For this reason, darker colors of paper will work better than bright white.

- Temporarily close suspected rodent burrows or holes with soil, crumpled paper, aluminum foil, or sawdust. Inspect 24 hours later to see if the holes have been opened or the paper chewed or moved.

### Monitoring Blocks/Monitoring Stations

Non-toxic, food attractant blocks are commercially available for monitoring rodents. You can also use bait stations filled with non-toxic baits such as rabbit food or grains. These monitoring blocks or stations can be placed anywhere indoors or out to locate or monitor a rodent population simply by noting whether animals have fed on the bait. Monitoring blocks or stations can also help you gauge the effectiveness of your treatment efforts. The blocks or bait stations should be wired, staked, or glued down with caulk so they cannot be dragged away. Clearly mark the blocks or stations with a tag alerting people that a non-toxic, rodent monitoring program is underway.

Number each block or station and note its location on

your map. In 2 to 7 days, check for signs of rodent feeding and record the amount on a monitoring form.

The following are some of the best locations to place monitoring blocks:

- food storage areas
- kitchens—in closets and food storage areas
- locker rooms, break rooms, and teachers' lounges
- attics
- basements
- under and behind cabinets, appliances, computers, and electrical boxes
- in storage sheds, especially any containing grass seed, bird seed, etc.
- outdoors in dense vegetation and along buildings and fences

### Vigilance

You cannot relax after finding and treating a rodent infestation. Mice and rats are always a potential problem. Designate areas of high and low risk and continue to monitor the high risk areas perhaps every other week. Use monitoring blocks to help detect rodent presence. The low risk areas can be inspected

**Table 12-4. Nesting and Eating Habits of Norway Rats and Roof Rats**

	Norway Rats	Roof Rats
<b>Nesting Sites Outdoors</b>	<ul style="list-style-type: none"> <li>• in the ground, in burrows that are less than 18 inches deep and less than 3 feet long; burrow openings are 2 to 4 inches in diameter</li> <li>• burrow system can be quite complex and interconnected</li> <li>• in unused sewers or storm drains</li> </ul>	<ul style="list-style-type: none"> <li>• usually above ground: in trees, especially untrimmed palm trees; in dense, overgrown vegetation, especially Algerian ivy (<i>Hedera canariensis</i>); and in piles of wood and debris</li> <li>• in the ground if there are few suitable above-ground sites and there are no Norway rats nesting in the area</li> <li>• in unused sewers or storm drains</li> </ul>
<b>Nesting Sites Indoors</b>	<p>Usually in the lower floors of the building</p> <ul style="list-style-type: none"> <li>• in wall voids and crawl spaces</li> <li>• in storage rooms under pallets or equipment</li> <li>• behind seldom-used stored materials at the corners and backs of rooms</li> <li>• in any cluttered area that is little used</li> </ul>	<p>Usually in the upper part of the building</p> <ul style="list-style-type: none"> <li>• in the attic</li> <li>• in ceiling and attic voids</li> <li>• can also nest in the lower floors of a building</li> </ul>
<b>Eating Habits</b>	<ul style="list-style-type: none"> <li>• more likely to eat garbage than roof rats</li> <li>• prefer foods that are high in protein, such as fish, meat, nuts, grains, pet food, and insects</li> </ul>	<ul style="list-style-type: none"> <li>• prefer fresh plant material, such as nuts and seeds, fruit and vegetables, and tree bark</li> <li>• sometimes eat garbage and meat</li> </ul>

### Box 12-A. Physical Abilities of Rats

Rats have the ability to:

- pass through any opening as small as 3/4 inch in diameter
- walk along horizontal wires and climb vertical wires (especially roof rats)
- climb inside vertical pipes from 1 1/2 to 4 inches in diameter
- climb outside of vertical pipes that are up to 3 inches in diameter
- climb the outside of vertical pipes and conduits of any size if within 3 inches of a wall; Norway rats are not likely to climb vertical wires unless they are close to a wall
- crawl horizontally on any type of pipe or conduit
- jump vertically (from a standstill) at least 24 inches above a flat surface and horizontally at least 4 feet
- reach about 13 inches above a flat surface
- fall more than 50 feet and survive
- dive and swim underwater for as long as 30 seconds, and tread water for up to 3 days
- swim up through the water seal, or trap, of toilets
- swim as far as 1/2 mile in open water
- gnaw and leave marks on almost anything, including wood, chip board, lead pipes, cinder blocks, asbestos, aluminum, sheet metal, sun-dried adobe, and an exposed edge of a piece of glass.

Sources: Caslick and Decker 1980, and Howard and Marsh 1967

once every quarter. It is important to pay attention to seasonal and other changes. Is there a wheat or cornfield next to the school? If so, at harvest time, field mice will often leave the field and seek shelter in the nearest building. Is new construction or demolition starting next door to the school? Rats will be displaced and could invade the school yard and buildings. These are times for renewed vigilance.

## MANAGEMENT OPTIONS

Initially, concentrate control efforts in the high risk/high priority areas, such as the kitchen, the cafeteria, locker rooms, and perhaps various storage rooms. Your inspection will reveal the precise areas you must concentrate on in your own school. After you have improved sanitation in these areas, worked on rodent exclusion, and trapped most of the offending animals, move on to the other areas you noted in your inspection. You need not tackle the entire school at once.

## Habitat Modification

It is very important to change the physical environment that is supporting rodents. As mentioned before, if rodents are killed but habitat and food are still available, it is very likely that new rodents will move in to replace the dead ones.

## Reducing Food Availability

- Store foods such as grains, pet foods, snacks, etc. in metal, glass, or heavy plastic containers with tight-fitting lids.
- Food stored in classrooms or teachers' lounges should be in tightly closed containers. Do not leave food out overnight.
- Do not allow students to store food in their lockers overnight unless it is in rodent-proof containers. Explaining to them why this is important will help with compliance.
- Store fresh fruits and vegetables in refrigerators or in open air coolers that are screened with 1/4-inch, heavy wire mesh.
- Store bags of grass seed, dry pet food, and other similar items in rodent-proof containers, or at the very least, inspect them frequently for any signs of chewing.
- Promptly clean up any spilled bird seed around feeders.

## Limiting Areas for Eating

If you expect to contain and limit pest problems (cockroaches and ants as well as rodents), it is very important to designate appropriate areas for eating and to enforce these rules. The fewer designated areas, the easier it will be to limit the pests.

Table 12-5.

### The Biology of the House Mouse

Breeding (estrous) cycle	polyestrous, every 4 days all year
Litter size	4 to 8
Litters per year	6 to 8, depending on food available
Age at weaning	21 to 28 days
Gestation period	18 to 21 days
Sexual Maturity	5 to 9 weeks
Life span in the wild	less than one year, perhaps up to years under excellent conditions

Source: Frantz & Davis 1991

## Box 12-B.

### Physical Abilities of the House Mouse

Mice have the ability to

- jump up to 12 inches from the floor, use vertical surfaces as a spring board to gain additional height, and jump downward 8 feet to the floor
- run up almost any vertical surface, including wood, brick, metal pipes and girders, sheet metal, wire mesh, and cables
- easily run along suspended electric wires and ropes of most common sizes
- squeeze through a 1/2 inch diameter hole
- travel upside down, clinging from 1/4 inch hardware mesh
- swim well, but tend not to dive below the surface
- survive at 24°F for many generations

Adapted from Pinto 1992

### Managing Garbage Properly

In most areas, garbage is the main source of food for rats. An electric garbage disposal unit in the sink can make rat problems worse by providing them with food in the sewer system. Proper disposal of organic garbage (food waste, garden waste, pet waste) is essential.

- All food waste from the kitchen, cafeteria, and other areas should be separated from other garbage, drained so it will be as dry as possible, and then stored in sealed plastic bags. These bags must be placed in rodent-proof containers at the end of each day because plastic bags are not rodent-proof.
- In food preparation areas, thoroughly rinse all cans, bottles, and plastic containers before recycling or discarding.
- Make sure garbage can and dumpster lids seal tightly when closed, and remain closed when not in use, especially at night. Repair or replace garbage cans with holes or with lids that do not close tightly. Use stretchy fasteners over garbage can lids, if necessary.
- Clean garbage cans and dumpsters frequently to prevent the build-up of food waste. Dirty garbage cans not only attract pests, but also repel people who want to use the garbage cans so that trash ends up outside the can. Use a high pressure stream of water or a brush and soapy water, if necessary. If possible, dumpsters should be fitted with drains so dirty water can be drained. The plug should be snugly in place, except when hosing out the

dumpster; otherwise, rodents can enter the dumpster and it becomes a huge feeding station. Another option is to require the refuse company to clean the dumpster or replace it with a clean one more frequently.

- Do not store extra garbage in cardboard, plastic, or paper outside the garbage cans because they can be torn open by rats, dogs, raccoons, or other animals.
- Inspect dumpsters and other outdoor trash receptacles at the end of the day, and pick up any wastes lying on the ground.
- Garbage cans on the school grounds should have removable, domed tops with vertical, spring-loaded swinging doors. Line these cans with plastic bags that can be tightly sealed and emptied into rat-proof garbage containers every evening.
- Inform students, teachers, and staff of the importance of placing garbage inside the proper containers.
- Pick up cat and dog feces daily (rats will feed on these).
- Shovel, rake, or sweep up fallen fruit, nuts, and similar foods that may be feeding rats in the school yard. Dispose of in rat-proof garbage containers. Sometimes it may be necessary to strip trees of their fruits or nuts to get a rat problem under control.
- Store excess garden produce away from rats or dispose of it in rat-proof garbage containers.

### Removing Vegetation

- Trim trees, vines, bushes, grass, and weeds at least 12 to 18 inches from all buildings to decrease cover for rodent runways and prevent hidden access to buildings.
- Break up dense plantings with pathways, stretches of lawn, or very low groundcover. Rats don't like to move across areas where they can be easily seen.
- Avoid large plantings of a single groundcover that could allow rats to run for long distances without being seen.
- Thin out dense bushes to reduce rat habitat.
- Avoid planting date palms or Algerian ivy (*Hedera canariensis*) on the school grounds because rats can live in and feed on these plants.

### Excluding Rodents

Exclusion must be the basis of any reliable management program. Rodent-proofing will take time and should begin simultaneously with trapping and/or poison baiting. The following procedures are recommended:

### Large Openings in the Exterior of the Structure

- Seal holes larger than 3 inches in diameter with 1/4-inch hardware cloth, 19-gauge or thicker sheet metal, plaster, or mortar. Make supports or frames for the screen and make sure they are secured solidly to the building.
- If maintenance staff needs access to the opening, install a lockable door with a heavy-duty spring hinge that will automatically close the door if someone forgets.
- Look for holes in the building not only in the first 3 feet above the ground, but also at the roof line, in the eaves, and in attic and roof vents.
- Make sure all vents are screened with 1/4-inch hardware cloth and that existing screen is not ripped.
- Cover vent pipes with a square of 1/4-inch hardware cloth bent around the pipe and secured with a wire.

### Small Openings in the Structure, Inside or Out

- Depending on the material in which you find these openings, holes as small as 3/16 inch in diameter should be sealed. These holes are very important and are often difficult to find. If the holes are in materials that rats can gnaw, they can enlarge these holes until they can eventually squeeze through them.
- Seal small holes with steel or copper wool (copper will not rust) or with caulk.
- Check for gaps around exterior doors and seal with weather stripping. Metal kickplates can be used to prevent rodent entry. Use raised metal door sills when necessary.
- Some doors have vents or louvers in them as part of the ventilation system. It may be necessary to screen these. Sometimes pipes have been installed

**Table 12-6. Selected Pathogens Associated with the House Mouse, Roof Rat, and Norway Rat**

Disease	Causal Agent	Transmission (common routes)
bubonic plague (Black Death)	<i>Yersinia pestis</i>	infective flea bites
salmonellosis	<i>Salmonella</i> spp.	feces-contaminated food and water
lymphocytic choriomeningitis	LCM virus	contaminated food; dust from feces, urine, or saliva
ricketsialpox (or vesicular rickettsiosis)	<i>Rickettsia akari</i>	bite of infective house mouse mite, <i>Liponyssoides</i> (= <i>Allogermanyssus</i> ) <i>sanguineus</i>
leptospirosis, or infectious jaundice	<i>Leptospira icterohaemorrhagiae</i>	contaminated food, water, etc.
rat bite fever (Haverhill fever, Sodoku)	<i>Spirillum minus</i> , <i>Streptobacillus moniliformis</i>	rat bite, contaminated food
tapeworms	<i>Hymenolepis nana</i> , <i>H. diminuta</i>	droppings, contaminated food
favus, ringworm	<i>Trichophyton schoenleini</i>	direct contact, mites
murine typhus, or endemic typhus	<i>Rickettsia typhi</i> (formerly <i>R. mooseri</i> )	infective flea feces that contaminate broken skin, or are inhaled or eaten
Hantavirus Pulmonary Syndrome (HPS)	Sin Nombre Virus (SNV)	most common route of transmission is through breathing in the virus on/in aerosolized, infective rodent urine, saliva, and feces  mucous membranes can also be infected after one handles infective/contaminated materials (dirt, dust, rodent excreta, etc.)  a rodent bite is another, though less common route

Sources: Frantz 1988, Harwood and James 1979, Olkowski 1991, and Quarles 1995

## Box 12-C. Hantavirus

Hantavirus pulmonary syndrome (HPS) is a serious, often deadly, respiratory disease that has been found mostly in the rural areas of the western United States where there is an overpopulation of deer mice, *Peromyscus maniculatus*, the primary vector (see Table 12-2 for description). Other rodent vectors include the piñon mouse, *P. truei*; brush mouse, *P. boylii*; and various western chipmunks, *Tamias* spp.

The most common route of transmission is through breathing in the virus on or in aerosolized, infective rodent urine, saliva, and feces. Mucous membranes can also be infected by touching them with fingers that have been contaminated by handling infective or contaminated materials such as dirt, dust, rodent excreta, etc. Rodent bites can also spread the virus, but this is less common. Organisms such as ticks, lice, or fleas are not involved, and as of this writing no human-to-human transmission has been observed.

Human exposures have been mostly associated with agricultural activities such as planting and harvesting field crops, but a number of exposures have come from contaminated dwellings. Infections have occurred from staying in previously vacant cabins, from cleaning barns and other outbuildings, and from hiking and camping. Any time the rodent population becomes large enough to incubate large quantities of the virus, disease can result.

Symptoms of hantavirus usually appear within 2 weeks of infection, but can appear as early as 3 days to as late as 6 weeks after infection. The primary symptom of this disease is difficulty breathing, but other symptoms may include fever (101°-104°F), headache, abdominal and lower back pain, and sometimes nausea and vomiting. If any combination of these symptoms—especially difficulty in breathing—appear after direct or indirect exposure to rodents, contact your doctor immediately and be sure to mention your exposure to rodents.

To determine if deer mice are a problem in your area, call the local Cooperative Extension. In areas of known infection, trapping and cleanup should be done by a trained health department representative or pest control operator.

At present, the best means of protection against the virus is by excluding deer mice from buildings. Since the types of mice that carry hantavirus are difficult to identify, all wild rodents should be considered potentially infectious and should be avoided. Methods for exclusion for deer mice are the same as for any rodent. See the section on excluding rodents under Management Options for directions on rodent-proofing your school building.

When you are cleaning, you can minimize contamination by following these precautions:

- Wear latex or rubber gloves.
- Mix a solution of 1 cup bleach to 10 cups water or use a household disinfectant.
- Wipe down counter tops, cabinets, and drawers. Mop floors and baseboards.
- Thoroughly spray or soak any dead mice, droppings, or nesting areas with disinfectant or the 10% bleach solution.
- Do not vacuum, sweep or dust. This may spread the virus throughout the air. Use rags, sponges and mops that have been soaked in the disinfectant solution.
- Steam-clean carpets, rugs, and upholstered furniture.
- Wash clothes and bedding in hot water and detergent. Transfer to a dryer set on high.
- Dispose of contaminated items, including dead mice, in a double plastic bag.
- Disinfect or throw away the gloves you used.
- When you are done, wash your hands with soap and hot water.

Source: Centers for Disease Control and Prevention 1993

through the vents or louvers; make sure to seal any gaps around the pipes.

- Check areas where pipes and wiring enter buildings and close any gaps with caulk or with steel or copper wool.

### Air Conditioners

- These units can provide rodents with water, harborage, and access to the structure. Make sure each unit is well-sealed, especially those on the roof.

### Sewer Pipes

- Repair broken sewer pipes. Rats can dig into

broken sewer lines and swim up the trap in a toilet to get into a building.

- Toilet drains can be rat-proofed by feeding the pipe from the toilet bowl into a pipe section of larger diameter (Frantz and Davis 1991).

### Drains

- Cap the drains in basement floors so rats cannot enter through them.
- Install a brass drain cover or a perforated metal cap held in place by a hinge so it can be opened for cleaning. Make sure the unhinged type of cover is

## Box 12-D. Signs of Rodent Presence

### Live or Dead Rodents

- Seeing live rodents is the most obvious and certain sign of their presence. Seeing live rodents in the daytime usually means there is a heavy infestation, that their harborage has been disturbed, or that new rodents are moving into the area and haven't found any harborage yet.
- A freshly dead rodent is a sign of infestation, but this is not necessarily true with an old, dried body which may merely indicate a previous infestation.

### Droppings

- The largest number of droppings will be in feeding areas and near harborage.
- Rat droppings may be as large as 3/4 inch long and 1/4 inch in diameter. Mouse droppings are much smaller, about 1/4 inch long.
- Fresh droppings are moist, soft, black or nearly black, and they glisten or look wet. After a few days to a week, the droppings dry, become hard, and appear dull rather than shiny. In warm, dry atmospheres the droppings can lose their shine after only a few hours. After a few weeks, rat droppings become gray, dusty and crumbly, and mouse droppings become hard, dry, and dull or whitish.
- If very old droppings are moistened, they may look like new ones, but they will still be crumbly instead of soft.
- Sometimes lizard or bat droppings can be confused with rodents droppings, but both lizard and bat droppings contain many insect fragments that can easily be seen when the droppings are crushed.
- In order to monitor for current rodent activity, remove the droppings so that fresh droppings are apparent during future inspections.

### Damage to Goods and Structures

- Rodents gnaw to get at food in packaging or containers and to obtain nesting material.
- When rodents gnaw, their front teeth leave two parallel marks, about 1/8 inch across for rats and about 1/16 inch across for mice.
- Gnaw marks on doors or ledges, in corners, in wall material, or on stored materials as well as bits of gnawed wood, paper, cloth, packaging, etc. are good indications of rodent presence.
- Rats can gnaw through rusty sheet metal and sheet aluminum.

### Grease Marks or Rub Marks

- These marks on beams, rafters, walls, pipes, and other fixtures are the result of oil and dirt rubbing off rodents' fur along frequently traveled routes.

### Runs or Burrows

- These may be found outside along foundations, walls, or fences or under bushes or debris. Runs will look like tiny paths and burrows are open holes.

### Tracks

- Footprints and long, thin marks indicating a tail being dragged or rested can easily be seen on dusty surfaces, in mud, or in snow.

### Noises

- As rats gnaw, claw, fight, and scramble around inside walls they make noises. These are particularly audible at night when they are most active. A stethoscope may be used to pinpoint the activity. Mouse noises are harder to hear, but you can sometimes hear them scurrying and skittering around. Note that squirrels and other animals can make similar noises, so you should confirm rodent presence with other signs.

### Urine

- Rodent urine will fluoresce blue-white under ultraviolet light, but many other substances also fluoresce, so recognizing rat urine takes skill.

Adapted from Meehan 1984



threaded so it screws in place; otherwise, a rat can push it open.

- Place 1/4-inch galvanized hardware cloth under existing drain covers with holes larger than 1/2 inch.

### Debris and Clutter

- Clean up and organize storage rooms to eliminate as much clutter as possible. It's harder to detect rodent presence in such rooms and the clutter is attractive harborage.
- Outside, remove debris heaps, wood piles, or construction debris.

### Water

- Free-standing water in stagnant pools, ditches, orna-

mental pools, or fountains can provide rats with their daily ration of water. Drain or eliminate these sources where possible. Fountains and ornamental pools will pose a problem, but during severe rat infestations, they may need to be temporarily drained.

- Fix leaking pipes, faucets, or broken irrigation systems.
- Eliminate condensation in places like boiler rooms.

### Installing Barriers

- Make rat-proof barriers to separate landscaping from the foundations of buildings by digging a small trench 8 to 12 inches wide, 8 inches deep, and as long as the building. Fill this with pea gravel. Rats dislike burrowing in loose gravel and will be discouraged from trying to penetrate the foundation.
- Place barriers between and within walls to prevent rodent travel (see Figure 12-2). An open space between floor joists (as shown at A) gives rats free access to wall voids. Wood 2x4 stops (shown at B) are sometimes used on upper floors, but an incombustible material should be employed on lower floors. In old buildings, galvanized sheet metal (shown at C) can be cut to fit and nailed between studs, joists, floor, and sill. In new construction, incombustible stops of a good grade of cement are recommended (shown at D).
- Vertical barriers of galvanized sheet metal 18 to 24 inches high placed around stored flour or grain will exclude mice. Pallets containing stored food and paper supplies can be mouse-proofed by elevating the pallet on 12-inch cinder blocks, then covering the pallet with a layer of sheet metal so that the edges of the sheet metal extend 4 to 6 inches beyond the edges of the pallet. The edges should then be bent down toward the floor at a 45° angle.

### Box 12-E. How to Conduct a Rodent Inspection Inside

- Begin in the basement or substructure. Remember that you are trying to find as many areas as you can that might provide harborage, food, water, or access to the building.
- Make detailed notes on your schematic of the building.
- Try to locate all entry points and nesting areas. "Starter holes" for rodents to enlarge can be openings as small as 1/4 inch in diameter in walls, around pipe entries, sewer outlets, under doors, etc. Unscreened sewer outlets and even toilets can give rats access to buildings. Nests are often composed of things like shredded paper, pieces of plastic, and bits of fabric gathered together into a 5-inch diameter mass for mice and 8 to 12 inch diameter for rats. If you find clothing or paper that looks torn or shredded but doesn't look like a nest, you will most likely find the nest nearby.
- Look for water leaks and rooms where water condenses on the walls.
- Always be on the lookout for piles of trash, clutter, or other debris.
- Note where the custodians, teachers, and students take their breaks or eat lunch. These areas can present a sanitation problem.
- Rodents like to follow edges; inspect these areas for feces, rub marks, urine, or other indications of activity.
- Move to the main floors of the building and inspect locker rooms, home economics rooms, art rooms, child care areas, lower-grade areas, cafeteria, kitchen, and teachers' lounge. Even science rooms can have food for rodents.
- Continue into the attic to look for holes, nests, feces, and rub marks.

### Trapping Rodents

Many schools have concerns about the ethical implica-

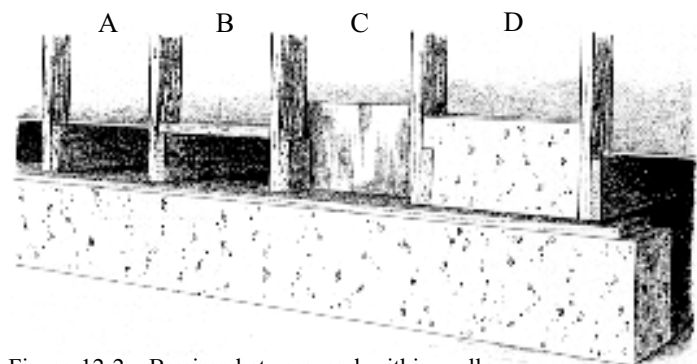

Figure 12-2. Barriers between and within walls

Adapted from Harmon 1995

tions of killing rodents slowly by trapping. Snap traps are probably the most humane in that regard because they kill the animals swiftly. These concerns for the animals can be turned into motivation for habitat modification and other strategies that exclude rodents and eliminate their food supply, thus reducing the numbers that have to be directly killed. Be sure to inspect the traps daily to remove and humanely kill any rodents that have been caught.

### **Killing trapped rodents**

- Plunge live capture traps or glue boards into a 5 gallon bucket of soapy water and hold down until the rodents drown.
- Place a few traps into a large, heavy-duty garbage bag and tie the bag loosely to the exhaust pipe of a car. Open the car windows, start the car, and leave it running for a minute or two. After turning off the car, remove the bag from the exhaust pipe, seal the bag and leave it for several more minutes.

### **Tips for a successful trapping program**

- Set traps in the correct locations, bait properly, and inspect frequently—sometimes this will mean daily.
- Use the map of the building and/or grounds to record the precise location of each trap and the date it was set. This record keeping is the key to preventing lost and forgotten traps. If dead and decomposing rodents are left in the traps, the results can be very unpleasant.
- When handling traps, always wear gloves for protection from diseases.
- Rats will avoid traps for a few hours to several days after initial placement. “Pre-baiting” traps for rats (see below under Baits) can improve catches.
- For mice, set a large number of traps for a few days, then remove the traps and dispose of dead mice. Reset traps two weeks later. This will ensure that mice too small for capture during the first trapping are caught in the second round.

### **Box 12-F. How to Conduct a Rodent Inspection Outside**

- Try to identify as many of the areas as possible that provide rodents harborage, food, water, and access to the building.
- Make detailed notes on your map of the exterior of the building and the school grounds.
- Take note of how garbage is dealt with, what condition dumpsters and garbage cans are in, and whether rodents have easy access to garbage.
- Check doorways for gaps or holes and note windows without screens or glass.
- Look for other openings in the structure—holes, vents without screens, holes around plumbing, and electrical wire entry points.
- Note any power lines running into the upper portions of buildings and any trees which are brushing up against the structure; these give rodents access to the roof.
- Note any bird or bat problems because rats may not be far behind. Rodents will feed on bird eggs, chicks, and young bats.
- What kind of vegetation is growing near the building? Does it give rodents cover for runways or nesting sites? Are there any fruit- or nut-bearing trees?
- Inspect all planters, wood waste piles, portable storage containers, and outbuildings. Are there signs of rodent infestation in or around any of these areas?
- Take into account any field or lot which may be next door, as well as any supermarket or fast food establishment which may attract rodents. Rodents that start to invade the school may be an overflow from adjoining properties. If a vacant building next door to a school is going to be renovated or an empty field or lot prepared for construction, the rodent population will be displaced to the surrounding areas.
- Pay attention to seasonal occurrences. For example, if there is a corn or wheat field near the school, when the grain is harvested in the fall, field mice often migrate to the nearest structure.
- Check for irrigation leaks and any standing water such as irrigation or drainage ditches, stagnant pools, ornamental ponds, and fountains.
- On the roof, check air conditioning units that might provide water and harborage for rats.

Adapted from Harmon 1995

### Making an Expanded Rat Trap Trigger

Rat traps with expanded triggers are available commercially, but you can also make your own. Cut a 1½ in. (3.8 cm) square piece of stiff cardboard or 1/8 in. (0.3 cm) thick wood and attach it to the existing trap trigger with wire or strong glue. Expanded triggers often catch rats without bait if the traps are placed well and are moved



Figure 12-3. Rat traps

- If catches are poor, try moving the traps to new locations.
- When most of the rats have been trapped, it can be hard to catch the last few because they may have become trap-shy and will avoid the traps. In such cases, the traps can be removed for a week, then set in new locations using the pre-baiting method described below. You can also leave out food in shallow pans until the rats readily eat it, and then camouflage the trap by burying it under the food in the pan.

#### Trap choices

Rodent traps fall into three general categories: snap traps, live traps, and glue boards. Each kind of trap is better suited to some situations than others. The information below will help you decide where to best use each of the traps.

**Snap Traps.** These traps are widely available and can be made more effective by expanding the trigger (see Figure 12-3) so that it can be tripped by a mouse or rat simply running over the trap. Do not place them where human toes might accidentally get caught, unless the traps are protected inside a bait station (see below). These traps work well in dusty places, but do not use a snap trap in an area with standing water or high humidity because the mechanism will rust and the trap will be useless.

**Live Capture Traps.** Live traps are available for rats and mice, but the rodents must be killed once they are trapped. When mouse populations are high, multiple-catch live traps may be more efficient than snap traps. Multiple catch traps can capture several mice at a time without needing to be reset. Some models have wind-up mechanisms that “kick” the mice into another compartment. Others use a treadle door. Although these traps can work without baits because mice are curious and

attracted to the small entrances designed into the traps, they are more effective when baited.

**Glue Boards.** These are boards covered with a sticky material that will catch mice and rats. Glue boards provide the advantage of catching and retaining rodent hairs, droppings, and ectoparasites coming from the trapped animal. Glue board traps should be inspected daily in order to prevent unnecessary suffering by the trapped animals.

If glue boards are used in areas where they might fall and get stuck to something, secure the traps with a nail or wire. Boards should always be secured when you are trapping rats so that if the rats are only partially caught they cannot drag the traps away. Baiting glue boards is not necessary but will improve the chances of success.

#### Trap Placement

- Check the monitoring map to locate active rodent holes, and set traps along walls or other runways leading to the holes. Other good trap locations include areas near droppings, gnawing marks, or other signs of rodent damage; under and behind objects likely to harbor rats or mice; in dark corners; and along rafters or other protected areas where rodents are likely to travel.
- Changing the location of furnishings will produce new pathways that mice will quickly investigate. Traps can be placed along these new pathways. For rats, move objects around to funnel them into the traps.
- Set traps at right angles to the wall, with the trigger facing the wall.
- Place traps flush with the wall so that rodents traveling along the edge of the wall will encounter the traps.
- Two traps, side by side with their triggers facing the wall, can increase the chances of success. Alternatively, the two traps can be placed parallel to the wall, back to back with their triggers facing away from each other. Three traps in a row will make it difficult for a rat to jump over the traps without being caught.
- Traps can also be nailed to a wall or rafter or wired to a pipe. Make sure the trigger side of the trap is projecting into the rodents’ runway.
- When trapping rats with snap traps, it may be useful to secure the trap so that if a rat is only partially caught, it cannot drag the trap away to an inaccessible area.
- A trap can be camouflaged by sinking it just below

---

ground level on dirt surfaces. This is done by positioning the trap and then completely covering it with a fine layer of sand or sawdust. Traps can also be set in shallow pans filled with sawdust, grain, or meal. It may be necessary to place a small piece of cloth over the trigger to keep it from jamming.

### **Baiting the Traps**

- Bait for Norway rats include pieces of hot dog, bacon, liver, peanut butter, or nut meats. Suggested baits for roof rats include nuts, dried fruits, or fresh fruits such as bananas or apples. You can also try other baits such as candy, marshmallows, raisins, or peanut butter mixed with rolled oats or bacon grease. Many of these baits don't last long because they dry up or become rancid. If rats are feeding on other foods, try them as baits also.
- For catching mice try raisins, gumdrops, or a mixture of peanut butter and rolled oats or bacon grease. A small piece of cotton can be attached to the trigger instead of food. The cotton makes attractive nesting material, will not spoil, and is less likely to attract new pests such as flies, cockroaches, etc.
- Place the bait in the center of the trigger. Baits that do not stick to the trigger can be tied on with string or dental floss so the rodent cannot steal the bait without tripping the trigger.
- To catch rats, you will probably have to "pre-bait" the traps. This may not be necessary for mice, unless you find them avoiding the traps. Place the traps out with bait but do not set the traps. Check them daily to see if the bait has been taken, and move them to a new location if the bait remains undisturbed. Once you see signs of feeding on the bait, refill the bait and set the traps.
- Alternatively, pre-bait the traps with a large piece of peanut butter, hot dog, liver, or fruit. When you are ready to set the traps, remove the large piece of bait and smear a small bit on the underside of the trigger. The animals will have become used to taking the bait from the trigger and will now try to manipulate the trigger to find the bait they know should be there.
- Cereal (like oatmeal) can be sprinkled around the traps to make them more attractive.
- Remember that you will probably have to experiment to find the bait that works best in your situation.

### **Number of Traps to Use**

- It is difficult to give a formula for the number of traps to use because the appropriate number will depend on the situation; however, it is better to err on the side of too many traps than too few. Place traps where you see activity and try using traps every 2 to 3 feet along a wall. You may need 3 to 6 traps around each hole or burrow opening.
- Concentrate the traps in one area at a time. When you have finished trapping in that area, move the traps to your next target.

### **Protecting Snap Traps**

- If safety or tampering is a concern, you can place a snap trap inside a cardboard rat bait station that has been assembled inside-out to hide the poison warnings. Use only rat bait stations; a mouse station is not large enough to allow traps to fire. Place the bait station on its side against the wall with the entry holes closest to the floor. Set and insert a baited rat or mouse snap trap with its trigger facing the entry hole. By placing two of these bait station traps back to back, the rodent will be caught traveling in either direction.
- Mouse snap traps can also be placed inside PVC pipe. Use pipe that is at least 3 1/4 inches in diameter so the traps have room to fire. Place two traps end to end inside the pipe with the triggers facing the cut ends of the pipe. PVC piping is available at plumbing supply stores and can easily be cut to the desired length.

### **Protecting Glue Boards**

Glue boards can be used inside professional cardboard rat or mouse bait stations. This extends the life of the board by protecting it from dust, dirt, children, and tampering. This method also hides the catch from view. The following points will help you set up the traps:

- Assemble the cardboard bait station inside-out to conceal the rodenticide warnings.
- For mouse bait stations, you will need to cut or fold the glue board to fit inside the station before you remove the protective release paper from the board.
- Remove the glue board from the bait station to dispose of the rodent and replace with a new board.

Glue boards can also be placed inside a length of PVC pipe along exterior foundations or indoor walls. Curl the glue board inside the pipe, making sure that the curve of the board matches the contour of the pipe.

### **Glue Boards in Multiple Catch Mouse Traps**

This combination allows the multiple catch trap to be serviced quickly, prevents mice from leaping out of

---

the trap at service time, keeps the trap cleaner, protects the glue board, and contains hairs, droppings, and ectoparasites.

### **Miscellaneous Points**

- Do not spray insecticides on the traps and do not store them with insecticides, rodenticides, or application equipment. The traps will smell of these substances and rats will avoid them.
- To prepare snap traps for storage, scrub them with a stiff brush, soak them in detergent and water, dry them carefully, and coat the metal parts with a thin layer of oil.

### **Repellent Sound Devices**

There is no evidence to show that these devices either kill rodents or prevent them from entering buildings. The Federal Trade Commission has ruled that these devices are ineffective in controlling rodents and insects, that they do not prevent pests from entering an area, and that the sound does not cover the area advertised.

### **Biological Controls**

Some institutions maintain cats for protection against rodents. Cats can “prune” a mouse population but seldom eliminate it. They can be a deterrent to new mouse immigration, although it is entirely possible to have alert cats and still have mice present.

Cats can kill rats as well, especially young rats; however, as with mice, cats are not a guaranteed rat deterrent. Owls and snakes are rat predators, so when considering the use of chemical control techniques, remember that depending on the toxicant used, these predators can be killed by consuming poisoned rats.

### **Chemical Controls**

If non-chemical methods alone prove insufficient to solve the problem, then integrating a rodenticide into your management program may be warranted. For information on the hazards of various rodenticides and on how to select an appropriate rodenticide for your situation, consult Appendix G for a list of resources.

Rodenticides must be used in accordance with their EPA-approved label directions. Applicators must be certified to apply rodenticides and should always wear protective gear during applications. All labels and Material Safety Data Sheets (MSDS) for the rodenticide products authorized for use in the IPM program should be maintained on file.

Baits and bait stations will be avoided for a few hours to

several days after initial placement. Even after this period, rats will be very cautious about approaching them. If a rat nibbles on a bit of poison bait that later makes it sick without killing it, the rat will avoid similar baits in the future, and, if female, may teach her young to do the same.

### **When to Use a Poison-Baiting Program**

It is appropriate to use poison-baits when trapping and physical changes to the building and to food and waste storage have been clearly documented to be ineffective. In emergency situations when there are very high numbers of rodents or when rat fleas have been identified as transmitting bubonic plague, it may be appropriate to use poison baits, but trapping and habitat modification must also be used at the same time.

Be aware that overuse of some rodenticides has produced rodent populations resistant to the poisons. Rodenticides should be used only if absolutely necessary. This approach preserves their effectiveness when they are needed to handle emergency situations.

### **Safety Precautions**

- All rodenticides must be placed inside tamper-resistant bait stations. These are metal or heavy plastic boxes that lock with a metal screw and can be filled with poison bait. They protect bait from humans and pets, and can be easily inspected to determine how much bait is being consumed. Bait stations should always be secured to the floor, a wall, or some other surface and be clearly labeled with a warning.
- Use poison baits over long holidays when students are not in the building.
- Use only in locked storerooms, basements, attics, or other areas not accessible to children or escaped classroom pets.
- Rats may cache (hide) food that may or may not be eaten later. This is very important to remember when using poison baits because rats may take the poison bait to a place where children and animals can find it, or to other locations the label does not allow, or may hide it without eating it. Some forms of baits, such as grain or meal, paraffin blocks, and water baits, are not as readily distributed by rats.
- Handle rodent carcasses with gloves.
- Keep unused bait in its original container in a locked cabinet with appropriate warnings on the outside of the cabinet door. (If baits are stored with other chemicals, put the original container into an airtight one so the bait will not absorb odors that may impair its effectiveness.)

---

## Rodenticide Formulations

- Liquid formulations are dispensed in special bait stations made especially for liquids and are most useful for rats in situations where water is very restricted and food is plentiful. Liquid bait must always be used where non-target animals and children have NO ACCESS.
- Meal formulations, e.g., cornmeal or oatmeal mixed with a poison, are a good choice because mice or rats are less likely to drop and/or take away much of the meal. Canarygrass seed bait is particularly attractive to mice.
- Parafinized bait blocks are useful in wet situations where dampness could spoil other baits. These blocks must be wired to the bait station so they cannot be dragged away.

## Types of Rodenticides

In general, the older anticoagulant rodenticides such as warfarin, chlorophacinone, and pindone are recommended over the newly developed anticoagulants. The older anticoagulants last for only a few days in a dead rodent body so that they pose less of a hazard to non-target organisms than some other rodenticides such as brodifacoum, which can last for many months. Zinc phosphide, an acute poison, can be useful for burrow baiting in its wax pellet formulation.

Anticoagulants work by preventing blood from clotting. Rodents eat small doses of these chemicals over several days and eventually die from internal bleeding.

## Resistance Problems

Many rats and mice have become resistant to some anticoagulants. This means that the rodents can eat the anticoagulant and not sicken or die. Resistance to a chemical should be suspected if the bait is eaten regularly but the same or a greater number of rodents, holes, droppings, etc. continue to be seen. Research has shown that even rats that are classified as “resistant” to warfarin eventually succumb to the poison if enough time (at least 30 days) is allowed to lapse between exposures (Frantz and Padula 1990). This seems to indicate that it may not be necessary to resort to the newer and more problematic rodenticides if the rodenticide producing resistance can be withdrawn from use for a period of time. During that time, focus on eliminating food and harborage.

## Instituting a Poison Baiting Program

Before beginning a baiting program, use monitoring

blocks or stations (see the discussion under Detection and Monitoring, above) to determine the locations where rodents are most likely to accept poison bait.

Points to remember when instituting a baiting program include the following:

- Bait stations must always be secured in place and clearly labeled “RODENT BAIT—POISON—DO NOT TOUCH.”
- Set out bait stations only where rodents are most active and have previously gnawed on monitoring blocks. Place bait stations along walls and, whenever possible, between shelter and the source of food. In the case of roof rats, bait stations should be placed above the ground in areas such as attics, roofs, or trees.
- For rats, bait stations should be placed 15 to 30 feet apart, for mice, 6 to 8 feet apart.
- Mark the location of each bait station on your building map.
- Check each bait station daily to make sure there is enough bait (this is extremely important), the bait is in good condition (not moldy or rancid), and the bait station is not being tampered with.
- Leave bait stations in place for the number of days recommended on the label. Mice will readily investigate new things in their territory, but it may take 4 or more days for the rats to try the bait.
- Multi-dose anticoagulants take from 4 to 9 days to kill rodents if the bait is the only food source.
- Rats have an excellent sense of taste, enabling them to detect extremely small amounts of rat poison very quickly. For this reason, poisoned baits must be more attractive to rats than the other foods that are available to them in the area.
- Remove and securely store all bait stations when the baiting program is over.

## BIBLIOGRAPHY

- Bio-Integral Resource Center (BIRC). 1996. 1997 directory of least-toxic pest control products. *IPM Practitioner* 18(11/12):1-39.
- Baker, R.O., G.R. Bodman, and R.M. Timm. 1994. Rodent-proof construction and exclusion methods. In: *Prevention and Control of Wildlife Damage*, pp. B137-B150. University of Nebraska, Lincoln.
- Caslick, J.W. and D.J. Decker. 1980. Rat and mouse control. Cornell Cooperative Extension, Ithaca, NY, Bulletin 163.
- Centers for Disease Control and Prevention. 1993. Hantavirus infection—Southwestern United States. Interim recommendations for risk reduction. *Morbidity and Mortality Weekly*

- 
- Report 42(No. R-11):1-20.
- Corrigan, R.M. 1994. Managing field mice. *Pest Management* 13(7):8-12.
- Dodds, W.J., S.C. Frantz, and K. Story. 1986. *The Professional's Guide to Managing Poisoning by Anticoagulant Rodenticides*. Chempa Products Div., Lipha Chemicals, Inc., New York. 10 pp.
- Ebeling, W. 1975. *Urban Entomology*. University of California, Los Angeles. 695 pp.
- Fehrenbach, P. 1994. Are PCO's at risk? *Pest Control Technology* 22(8):32-34,108.
- Frantz, S.C. 1979. *Rodent Control—A Case for Integrated Pest Management (IPM)*. U.S. Public Health Service, Center for Disease Control, Preventive Health Services Conference, Ellenville, NY. May 7-11, 1979. 29 pp.
- Frantz, S.C. 1980. *Integrated Pest Management: Philosophy and Basic Guidelines*. National Association of Housing and Redevelopment Officials, Albany, NY. Sept. 3 -4, 1980. 20 pp.
- Frantz, S.C. 1988. Architecture and commensal vertebrate pest management. In: *Architectural Design and Indoor Microbial Pollution*, R.B. Kundsins, ed., Oxford University Press, New York, NY.
- Frantz, S.C. and D.E. Davis. 1991. Bionomics and integrated pest management of commensal rodents, pp. 243-313. In: *Gorman, Ecology and Management of Food-Industry Pests*. Association of Official Analytical Chemists, Arlington, VA.
- Frantz, S.C. and C.M. Padula. 1990. Recent developments in anticoagulant rodenticide resistance studies: surveillance and application in the United States. In *Proceedings of the 9th Vertebrate Pest Conference*. J.P. Clark, ed. University of California Press, Davis, CA. pp. 80-88.
- Goldstein, M.M. 1995. Teaching old pro's new tricks: utilizing existent rodent IPM tools in new ways can result in greater rodent catch and time savings. *Pest Control Technology* 23(8):48,50,52.
- Gorman, J.R., ed. *Ecology and Management of Food-Industry Pests*. FDA Tech. Bulletin 4. Association of Official Analytical Chemists, Arlington, VA. 595 pp.
- Gunther, R., et al. 1988. Toxicity of vitamin D3 rodenticides to dogs. *Journal of the American Veterinary Medical Association* 193(2):211-214.
- Harmon, J. 1995. Classy vermin: controlling rodents in schools. *Pest Control Technology* 23(9):38,40,49,52,54,112.
- Harwood, R.F. and M.T. James. 1979. *Entomology in Human and Animal Health*, Seventh Edition. Macmillan, New York, NY. 548 pp.
- Howard, W.E. and R.E. Marsh. 1967. *The rat: its biology and control*. University of California, Davis. Division of Biological Science, Cooperative Extension Service (Leaflet 2896). 22 pp.
- Hygnstrom, S.E., R.M. Timm and G.E. Larson. 1994. *Prevention and Control of Wildlife Damage*. University of Nebraska, Lincoln.
- Ingles, L.G. 1965. *Mammals of the Pacific States*, California, Oregon, and Washington. Stanford University Press, Stanford, CA. 506 pp.
- Kundsins, R.B., ed. 1988. *Architectural Design and Indoor Microbial Pollution*. Oxford University Press, New York, NY.
- Marsh, R.E. 1994. Roof rats. In: *Prevention and Control of Wildlife Damage*, pp. B125-B132. University of Nebraska, Lincoln.
- Meehan, A.P. 1984. *Rats and Mice: their biology and control*. Rentokil Ltd., East Grinstead, England. 383 pp.
- Moore, F., et al. 1988. Hypercalcemia associated with rodenticide poisoning in three cats. *Journal of the American Veterinary Medical Association* 193(9):1099-1100.
- Olkowski, W., S. Daar, and H. Olkowski. 1991. *Common-Sense Pest Control: Least-toxic solutions for your home, garden, pets and community*. Taunton Press, Newtown, CT. 715 pp.
- Pinto, L. 1992. Module III, vertebrates. In: *Urban Integrated Pest Management: a guide for commercial applicators*, Chapter 3, pp. 1-7. Dual & Associates Inc., Arlington, VA.
- Quarles, W. 1995. Deer mice spread new hantavirus. *Common Sense Pest Control Quarterly* 11(1):13-15.
- Scott, H.G. 1991. Design and construction: building out pests, pp. 331-343. In: *Gorman, Ecology and Management of Food-Industry Pests*. Association of Official Analytical Chemists, Arlington, VA.
- Timm, R.M. 1983. House mouse. In: *Hygnstrom, Timm and Larson, Prevention and Control of Wildlife Damage*, pp. B17-B44. University of Nebraska, Lincoln.
- Timm, R.M. 1994. Norway rats. In: *Hygnstrom, Timm and Larson, Prevention and Control of Wildlife Damage*, pp. B105-B120. University of Nebraska, Lincoln.
- Timm, R.M. 1991. Chemical control of rodent pests in bulk-stored grains, pp. 419-426. In: *Gorman, Ecology and Management of Food-Industry Pests*. Association of Official Analytical Chemists, Arlington, VA.
- Timm, R.M. and G.R. Bodman. 1983. Rodent-proof construction. In: *Prevention and Control of Wildlife Damage*, pp. B125-B131. University of Nebraska, Lincoln.

---

# CHAPTER 13

## IPM FOR SCORPIONS IN SCHOOLS

### INTRODUCTION

Scorpions live in a wide variety of habitats from tropical to temperate climates and from deserts to rain forests. In the United States they are most common in the southern states from the Atlantic to the Pacific. All scorpions are beneficial because they are predators of insects.

The sting of most scorpions is less painful than a bee sting. There is only one scorpion of medical importance in the United States: the sculptured or bark scorpion, *Centruroides exilicauda* (=sculpturatus). The danger from its sting has been exaggerated, and its venom is probably not life-threatening. This species occurs in Texas, western New Mexico, Arizona, northern Mexico, and sometimes along the west bank of the Colorado River in California.

### IDENTIFICATION AND BIOLOGY

Scorpions range from 3/8 to 8 1/2 inches in length, but all scorpions are similar in general appearance.

Scorpions do not lay eggs; they are viviparous, which means they give birth to live young. As embryos, the young receive nourishment through a kind of “placental” connection to the mother’s body. When the young are born, they climb onto the mother’s back where they remain from two days to two weeks until they molt (shed their skin) for the first time. After the first molt, the young disperse to lead independent lives. Some scorpions mature in as little as six months while others take almost seven years.

All scorpions are predators, feeding on a variety of insects and spiders. Large scorpions also feed on small animals including snakes, lizards, and rodents. Some scorpions sit and wait for their meal to come to them while others actively hunt their prey. Scorpions have a very low metabolism and some can exist for 6 to 12 months without food. Most are active at night. They are shy creatures, aggressive only toward their prey. Scorpions will not sting humans unless handled, stepped on, or otherwise disturbed.

It is rare for scorpions to enter a building since there is little food and temperatures are too cool for their comfort. There are some exceptions to this rule. Buildings in new developments (less than three years

old) can experience an influx of scorpions because the construction work has destroyed the animals’ habitat. In older neighborhoods, the heavy bark on old trees provide good habitat for scorpions, and they may enter through the more numerous cracks and holes in buildings in search of water, mates, and prey. Also, buildings near washes and arroyos that are normally dry may become refuges for scorpions during summer rains.

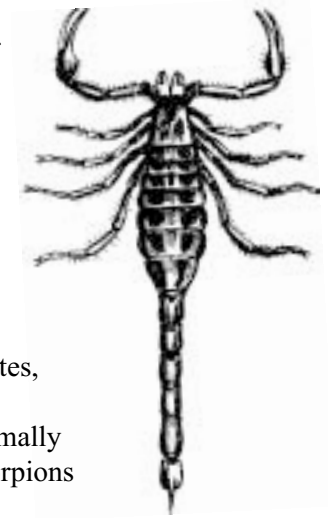

Scorpions do not enter buildings in winter because cold weather makes them sluggish or immobile. They are not active until nighttime low temperatures exceed 70°F. Buildings heated to 65° or 70°F provide enough warmth to allow scorpions to move about. Scorpions found inside buildings in cold weather are probably summer visitors that never left. Although scorpions prefer to live outdoors, they can remain in buildings without food for long periods of time.

### STINGS

A scorpion sting produces considerable pain around the site of the sting, but little swelling. For four to six hours, sensations of numbness and tingling develop in the region of the sting, then symptoms start to go away. In the vast majority of cases, the symptoms will subside within a few days without any treatment.

If the sting is from a bark scorpion, symptoms can sometimes travel along nerves, and tingling from a sting on a finger may be felt up to the elbow, or even the shoulder. Severe symptoms can include roving eyes, blurry vision, excessive salivation, tingling around the mouth and nose, and the feeling of having a lump in the throat. Respiratory distress may occur. Tapping the sting can produce extreme pain. Symptoms in children also include extreme restlessness, excessive muscle activity, rubbing at the face, and sometimes vomiting. Most vulnerable to the sting of the bark scorpion are children under five years and elderly persons who have an underlying heart condition or respiratory illness. The greatest danger to a child



---

## Avoiding Scorpion Stings

Schools in areas where encounters with scorpions are likely should teach children and adults how to recognize scorpions and to understand their habits. Focus on scorpion biology, behavior, likely places to find them, and how to avoid disturbing them.

At home, children and parents should be taught to take the following precautions to reduce the likelihood of being stung:

- Wear shoes when walking outside at night. If scorpions are suspected indoors, wear shoes inside at night as well.
- Wear leather gloves when moving rocks, boards, and other debris.
- Shake out shoes or slippers before they are worn, and check beds before they are used.
- Shake out damp towels, washcloths, and dishrags before use.
- When camping, shake out sleeping bags, clothes, and anything else that has been in contact with the ground before use.
- Protect infants and children from scorpions at night by placing the legs of their cribs or beds into clean wide-mouthed glass jars and moving the crib or bed away from the wall. Scorpions cannot climb clean glass.

is the possibility of choking on saliva and vomit.

Antivenin for the bark scorpion is produced at Arizona State University in Tempe and is available in Arizona but not in other states. The therapeutic use of antivenin is still experimental. People have been treated without antivenin for many years, and in areas where antivenin is unavailable, people are monitored closely by medical professionals until the symptoms subside.

## DETECTION AND MONITORING

To determine where scorpions are entering, inspect both the inside and outside of the building at night (when scorpions are active) using a battery-operated camp light fitted with a UV (black) fluorescent bulb. Scorpions glow brightly in black light and can be spotted several

yards away.

Always wear leather gloves when hunting scorpions. Places to check inside the building include under towels, washcloths, and sponges in bathrooms and kitchen; under all tables and desks, since the bark scorpion may climb and take refuge on a table leg or under the lip of a table; and inside storage areas. Outside, check piles of rocks and wood, under loose boards, and in piles of debris. After the following treatment strategies have been implemented, monitoring with the black light should continue to verify population reduction.

## MANAGEMENT OPTIONS

### Physical Controls

In most cases, physical controls will be adequate to manage a scorpion problem.

### Removal of Scorpions

Any scorpions found during monitoring can be picked up using gloves or a pair of kitchen tongs, and transferred to a clean, wide-mouthed glass jar. Scorpions cannot climb clean glass. You can also invert a jar over a live scorpion and then slide a thin piece of cardboard under the mouth of the jar to trap the scorpion inside. Once a scorpion is captured, drop it into a jar of alcohol or soapy water (water without soap will not work) to kill it.

### Habitat Modification

If you discover areas near school buildings that harbor a number of scorpions, you can try to alter the habitat to discourage them. Wood piles, rocks, loose boards, and other debris should be removed from the immediate vicinity of the building.

If there are slopes on the school grounds that are faced with rip rap (large rocks placed on a slope or stream bank to help stabilize it), or other similar areas highly attractive to scorpions, place a barrier of aluminum flashing between the rip rap and the school to prevent scorpion access. The flashing must be bent in an “L” shape away from the building. The other edge of the flashing should be buried a short distance from the rocks, deep enough in the soil so that the L shape will not fall over and lean on the rip rap. Make the height of the barrier before the bend greater than the height of the rip rap to prevent scorpions from standing on the rocks and jumping over the barrier.

Carry a caulking gun during nighttime inspections

inside and outside the building to seal any cracks and crevices found. If scorpions are entering through weep holes in windows or sliding doors, cover the holes with fine-mesh aluminum screening, available from hardware or lumber stores. The ends of pipes that are designed as gray water drains should be fitted with loose filter bags, or makeshift end-pieces made from window screen. The screened end will prevent scorpion access to the drainpipe, sink, and other parts of the building.

It is important to continue nighttime patrols and caulking until all entryways have been located and sealed, and all the scorpions in the building have been captured and killed. Once the access routes are sealed, and all indoor scorpions have been removed, only doorways provide access, unless the scorpions ride in on logs and other materials. Glazed tiles can be placed around the perimeter of the buildings, and under or around doors and windows as part of the decor and as practical scorpion barriers. Scorpions have difficulty crossing smooth tiles unless the grout line is wide. Wood storage should be elevated above the ground since scorpions like contact with moist soil. Before bringing materials such as logs inside, bang them on a stone to dislodge any scorpions.

### Traps

A simple trap made of damp gunny sacks laid down near the building in the evenings may be useful for monitoring and trapping. Scorpions may seek out the moist environment under the sacks where they can be collected in the morning. This trap is most effective when used before summer rains.

### Chemical Controls

In general, preventing scorpion problems is better than trying to kill these creatures with pesticide. Spraying the perimeters of buildings is not only unnecessary but also ineffective. Scorpions can tolerate a great deal of pesticide in their environment. The pesticide will only be harmful to humans, especially children, and to other wildlife. Using physical controls along with education to reduce the fear of scorpions will help prevent unnecessary treatments.

## BIBLIOGRAPHY

### First Aid for Scorpion Stings

Most scorpion stings are similar to a bee or wasp sting, and like bee or wasp stings, the majority of scorpion stings can be treated at school or the victim's home.

First aid for a scorpion sting includes the following:

- Calm the victim.
- Do not use a tourniquet.
- Wash the area with soap and water.
- Apply a cool compress (an ice cube wrapped in a wet washcloth), but do not apply ice directly to the skin or submerge the affected limb in ice water.
- To reduce pain, over-the-counter pain relievers such as aspirin or acetaminophen can help.
- Elevate or immobilize the affected limb if that feels more comfortable.
- Do not administer sedatives such as alcohol.

- Bio-Integral Resource Center (BIRC). 1996. 1997 directory of least-toxic pest control products. *IPM Practitioner* 18(11/12):1-39.
- Cloudsley-Thompson, J.L. 1968. *Spiders, Scorpions, Centipedes and Mites*. Pergamon Press, New York. 278 pp.
- Keegan, H.L. 1980. *Scorpions of Medical Importance*. Jackson University Press, Jackson, MS. 140 pp.
- Mallis, A. 1982. *Handbook of Pest Control*. Franzak and Foster, Cleveland, OH. 1101 pp.
- Olkowski, W., S. Daar, and H. Olkowski. 1991. *Common-Sense Pest Control: Least-toxic solutions for your home, garden, pets and community*. Taunton Press, Newtown, CT. 715 pp.
- Polis, G.A., ed. 1990. *The Biology of Scorpions*. Stanford University Press, Stanford, CA. 587 pp.
- Smith, R.L. 1982. *Venomous animals of Arizona*. Cooperative Extension Service, College of Agriculture, University of Arizona, Tucson, AZ, Bulletin 8245. 134 pp.
- Smith, R.L. 1992. Personal communication. Associate Professor, Entomology Dept., University of Arizona at Tucson.



---

## CHAPTER 14

# IPM FOR SILVERFISH, FIREBRATS, AND BOOKLICE IN SCHOOLS

### INTRODUCTION

The presence of silverfish, firebrats, or booklice is an indicator of excessive humidity. These insects can damage paper and book bindings, starched fabrics, cotton, linen, silk, rayon, cereals, and wallpaper. They also feed on the molds growing on various surfaces.

Silverfish, firebrats, and booklice are frequently introduced into a building with boxes of materials that have been stored in damp basements or attics, but they can also wander in from outdoors. They are fast-moving and can travel throughout buildings in ventilators or heating ducts originating in damp basements. Once these insects find a good source of food, however, they stay close to it. In general, they do very little damage, but they may be seriously upsetting to people who are afraid of insects. They may also attract spiders and scorpions that prey on these insects.

### IDENTIFICATION AND BIOLOGY

#### Silverfish and Firebrats

Silverfish (*Lepisma saccharina*) are about 1/2 inch long when fully grown, and are covered with silvery scales. They are grayish to greenish in color, have two long antennae, and their bodies have a flattened-carrot shape. There are three long appendages attached to the tapered posterior end, each about as long as the body. They do not have wings. Firebrats (*Thermobia domestica*) have a mottled appearance with patches of white and black, and are shaped similarly to silverfish.

#### Characteristics of Silverfish

- lay eggs in any season, usually in secluded places
- life cycle is 3 to 4 months
- prefer moist areas (75 to 97% humidity) and moderate temperatures (70 to 80°F)
- active at night or in dark places and rarely seen unless disturbed during cleaning
- indoors, may be found throughout the building—sometimes in boxes and books, or in glass utensils and sinks into which they have fallen
- leave yellowish stains on fabric
- outdoors, live in nests of insects, birds (especially pigeons), and mammals, and under the bark of trees

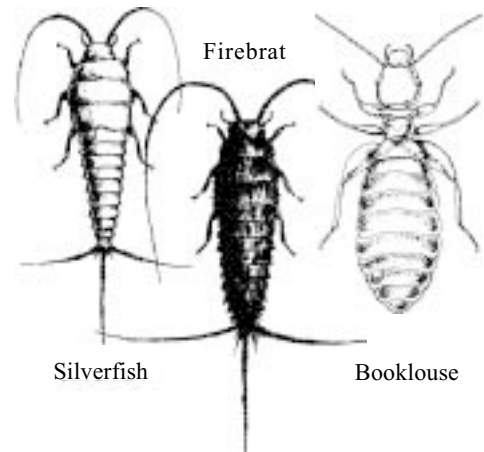

#### Characteristics of Firebrats

- lay eggs in cracks and crevices
- life cycle is a few weeks
- prefer moist areas with temperatures above 90°F
- active at night or in dark places
- found where heat and starches are present (for example, in bakeries); also found in furnace rooms, steam pipe tunnels, and partition walls of water heater rooms.

#### Booklice (Psocids)

The common booklouse (*Liposcelis* spp.) is a small, grayish, soft-bodied insect whose shape superficially resembles that of a head louse. Booklice are wingless and have chewing mouthparts. The size of an adult is approximately 1/25 to 1/12 inch. Relatives of the booklouse live outside under the bark of trees where they feed on molds.

#### Characteristics of Booklice

- life cycle is around 110 days
- prefer warm, moist conditions that are conducive to the growth of the mold and mildew they feed on; require humidity of at least 60%.
- found in books and paper products
- sometimes found on houseplants where they may be feeding on honeydew (a protein-rich substance excreted by plant-eating insects such as aphids), or more likely, on the sooty mold that grows on the honeydew

---

## DAMAGE

The mouthparts of silverfish and firebrats are used for biting off small particles or for scraping away at surfaces. Silverfish and firebrats eat material high in protein, sugar, or starch, including cereals, moist wheat flour, starch in book bindings, sizing in paper, and paper on which there is glue or paste. These insects often attack wallpaper, eating irregular holes through the paper to get to the paste. Silverfish may bite very small holes in various fabrics, including cotton, linen, and silk, even though they cannot digest either linen or cotton. Firebrats will feed extensively on rayon, whereas silverfish usually damage it only slightly.

Booklice cause little direct damage to plants and wood because they feed chiefly on mold. Damage to books may be more direct, since they eat the starch sizing in the bindings and along the edges of pages.

## DETECTION AND MONITORING

Silverfish are found in bookcases, on closet shelves, behind baseboards, wallpaper, window or door frames, and in wall voids, attics, and subfloor areas. They prefer bathrooms and kitchens because of the moisture. Firebrats will be found in similar but warmer areas. If you suspect that damage to books, carpets, curtains, art prints, or other materials is due to silverfish or firebrats, confirm your suspicions using the following test:

- Mix flour and water to the consistency of house paint.
- Coat one or more 3x5 index cards with the paste.
- Let the cards dry, and place them where you have spotted damage.
- If silverfish or firebrats are in the vicinity, they will be attracted to the card within a week and will feed on the paste. Characteristic feeding marks are minute scrapings in irregular patterns, and the edge of the card may be notched.

If you see groups of small whitish insects in damp areas, suspect booklice, particularly if mold is present or the area smells moldy. Remember that booklice are considerably smaller than silverfish, and lack the telltale three long bristles at the tail end.

Silverfish, firebrats, and booklice can also be detected by placing sticky cockroach traps in the area where damage is occurring. These traps, along with other

homemade ones, can also be used for control purposes (see the discussion below under Physical Controls). When the insects are caught, they should be preserved in alcohol for professional identification.

## MANAGEMENT OPTIONS

Management of booklice, silverfish, and firebrats is essentially the same. All three are living indicators of excessive moisture. An occasional individual is not a pest, and is usually tolerated by most people. Nonetheless, its presence should be taken as a sign to investigate moisture problems.

### Physical Controls

#### Dehumidifying

If moisture is not eliminated, it may bring more serious problems, such as termites, carpenter ants, and wood rot (see Chapter 17, IPM for Wood-Damaging Pests). School libraries and paper supply storage rooms could have independent dehumidification systems in areas where high humidity is a concern.

You can do the following to decrease humidity:

- Mend leaking pipes.
- Ventilate closed rooms and attics.
- Eliminate standing water.
- Replace any single-glazed window that repeatedly accumulates condensation with a double-glazed window.
- Use a dehumidifier in rooms such as bathrooms that are regularly moist.
- Use anhydrous calcium carbonate, a dehydrating agent that is available from chemical supply companies, or silica gel, available from camera stores, to absorb free moisture, particularly in enclosed areas. Silica gel is often packaged in small cloth bags that can be dried out in an oven and then reused. Do not use these agents in areas to which children have access.

#### Vacuuming

Regularly vacuum accumulations of lint in cracks and crevices. Wherever possible, such potential hiding and feeding areas should then be sealed with patching plaster and/or caulk.

#### Exposure to Heat and Cold

Firebrats die when exposed to a temperature of 120°F for

---

one hour. Below freezing and above 112°F, nymphs are killed quickly. Thus, in areas of the building where temperatures can be elevated, use hot air as a lethal treatment. After a general effort has been made to reduce the source of the humidity, a small heater can be used to warm and dry the problem area. The heat should be turned off before the wood surface gets too hot to touch. Books and similar materials that are suspected sources of infestations should be placed inside a plastic bag with a dehydrating agent (anhydrous calcium carbonate) and placed in the freezer for a week to kill all life stages of the insect.

### **Microwave Radiation**

Books infested by silverfish and booklice can be placed in a kitchen microwave oven for 30 to 60 seconds (Brezner 1988, Brezner and Luner 1989). Most books can undergo this treatment without any damage. The glue on paperback book bindings may soften initially, causing the book to curl a little, but if the book is set on a flat table, it will soon straighten out. This treatment is not recommended for very old books made of parchment or other fragile paper, or for books with gilding or color illustrations that may contain metallic salts in their paints—metals and microwaves don't mix.

### **Trapping**

Silverfish can be trapped very easily in small, clean glass jars. The outside of the jar should be wrapped with masking tape so the insects have something to grip as they climb up. Tests have shown that adding bait does not enhance the trapping power of the glass jars—they work just as well completely empty (Ebeling 1975). Set the jars upright in areas where silverfish have been seen. Silverfish can also be trapped in sticky cockroach traps. Remember that there is no point in trapping if the original moisture conditions are not corrected; pests will continue to migrate to the damp area.

### **Drying Stored Articles**

Periodic airing and drying of articles stored in damp areas may help reduce the mold on which booklice feed. Disposing of moldy articles is often the simplest way of ridding an area of booklice infestations.

### **Consider Structural Changes**

Condensation from wooden windows can cause mold to grow on and around windows. Sometimes the condensation can be eliminated by switching to aluminum win-

dows with double panes. Other structural changes should be considered in order to reduce moisture accumulations that lead to pest presence.

### **Chemical Controls**

It should not be necessary to use pesticides to control silverfish, firebrats, and booklice. Instead, focus on reducing humidity and on heating or freezing infested articles. When the pests are detected they can be vacuumed up.

If non-chemical methods alone prove insufficient to solve the problem, then integrating a pesticide into your management program may be warranted. For information on the hazards of various pesticides and on how to select an appropriate pesticide for your situation, consult Appendix G for a list of resources.

Pesticides must be used in accordance with their EPA-approved label directions. Applicators must be certified to apply pesticides and should always wear protective gear during applications. All labels and Material Safety Data Sheets (MSDS) for the pesticide products authorized for use in the IPM program should be maintained on file. Do not apply these materials when buildings are occupied, and never apply them where they might wash into the sanitary sewer or into outside storm drains.

Diatomaceous earth, borate-based insecticidal dust products, and silica aerogel can be used to kill these insects. Diatomaceous earth and borate-based products must be kept dry to be most effective, but silica aerogel will work under damp conditions.

Dusts should be applied only in cracks and crevices, attics, crawl spaces, and other areas that are relatively inaccessible to humans and pets. Wear a dust mask or a professional-quality respirator to provide proper lung protection when applying any dust.

Products commonly found in schools, such as bleach, ammonia, salt, and formalin can be mixed with water (use a 2% solution of formalin) and used to kill the molds on which booklice feed. In addition, pyrethrum insecticides are registered for the control of booklice. Pyrethrum degrades quickly so exposures can be minimized.

### **BIBLIOGRAPHY**

- 
- Bio-Integral Resource Center (BIRC). 1996. 1997 directory of least-toxic pest control products. *IPM Practitioner* 18(11/12):1-39.
- Brezner, J. 1988. Protecting books from living pests. TAPPI Paper Preservation Symposium. TAPPI Press, Technology Park, Atlanta, GA.
- Brezner, J. and P. Luner. 1989. Nuke 'em! Library pest control using a microwave. *Library Journal* September, 15:60-63.
- Ebeling, W. 1975. *Urban Entomology*. University of California, Division of Agricultural Sciences, Los Angeles, CA. 695 pp.
- Harmon, J.D. 1993. *Integrated Pest Management in Museums, Libraries and Archival Facilities*. Harmon Preservation Pest Management, Indianapolis, IN. 140 pp.
- Mallis, A. 1982. *Handbook of Pest Control*. Franzak and Foster, Cleveland, OH. 1101 pp.
- Olkowski, W., S. Daar, and H. Olkowski. 1991. *Common-Sense Pest Control: Least-toxic solutions for your home, garden, pets and community*. Taunton Press, Newtown, CT. 715 pp.

---

# CHAPTER 15

## IPM FOR SPIDERS IN SCHOOLS

### INTRODUCTION

Although few organisms create as much hysteria as spiders, this fear is largely unwarranted. Most spiders are too small or have venom too weak to harm humans. Many bites for which people blame spiders are really inflicted by other organisms such as insects (fleas, bedbugs, mosquitoes) or mites (scabies, bird mites, etc.).

The four types of spiders that cause the most concern are the black widow, brown recluse (or violin) spider, aggressive house (or hobo) spider, and tarantula. The tarantula's bite does not cause lasting pain, but if handled, its hairs can be irritating and can sometimes cause an allergic reaction. The other three spiders are potentially more dangerous to humans. Bites from these spiders can have painful consequences, but usually these spiders will bite only if provoked and only under certain circumstances.

Spiders are beneficial to humans because they feed on insects. Indoors and out, spiders help to control a wide variety of insect pests. Unfortunately, the majority of spiders that are seen and killed by people pose no threat to us at all.

### REMOVAL OF A NON-DANGEROUS SPIDER

Most spiders found in and around a school can be used as an educational opportunity to teach some interesting facts about these fascinating creatures. If any spider found in the classroom creates anxiety on the part of the teacher or children and the teacher wishes to remove it, use the following procedure:

- Invert a wide-mouthed jar over the spider.
- Using a piece of stiff paper or thin cardboard large

enough to cover the mouth of the container, slide it under the jar while keeping the jar pressed against the surface on which the spider is standing. Work slowly so the spider is not harmed.

- Keeping the card over the mouth of the jar, turn the jar over and tap the paper so the spider falls into the container.
- Holding the paper over the top as a cap, carry the jar outside and release the spider by shaking the container.

An unwanted tarantula can be removed by gently sweeping it into a dustpan, dropping it into a large paper bag, and releasing it outside.

### GENERAL SPIDER MANAGEMENT

You can control the number of spiders in an area by reducing their food supply. Study the situation to locate the source of their prey. Are too many flies getting in? If so, screens should be installed or repaired. Is security lighting attracting insects at night for spiders to feed on? Insects may also be attracted to poorly stored food or mishandled organic wastes. Eliminating the food source for these insects will reduce the food source for the spiders.

Unwanted spiders and their webs can be removed simply by vacuuming. In most cases, vacuuming and reducing the spiders' food source will be sufficient to control the problem. The three potentially dangerous spiders—black widow, brown recluse, and aggressive house spider—nest in undisturbed areas, often near the floor; therefore, thorough vacuuming from time to time in these areas can also help in their control.



Figure 15-1.  
Black Widow

## Black Widow Spiders

### IDENTIFICATION AND BIOLOGY

All the adult females of the three most common species of black widows in the United States (*Latrodectus variolus*, *L. mactans*, and *L. hesperus*) are large (body size is 1/2 inch or larger), shiny black spiders with a red

design on the underside of the abdomen that usually resembles an hourglass (see Figure 15-1). Because their webs are near the ground and the spiders hang upside down in the web, this distinctive marking is obvious. The adult male, which is not dangerous, is small and patterned



---

## FIRST AID FOR SPIDER BITES

If possible, capture the spider so the specimen can be taken to a doctor. Proper treatment may depend on identifying the species. Even the squashed remains of the spider can be useful for identification purposes.

Wash the area around the bite, calm the victim, and consult a doctor as soon as possible. Those particularly at risk are the very young, the elderly and sick, or people with high blood pressure. Although the illness and lesions from bites of the three spiders discussed in this chapter can be serious, deaths are rare.

with whitish streaks, bars, or dots on the top of the abdomen.

There is a red form of this genus in the sandy, scrub pine areas of central and southeastern Florida, as well as a tropical brown widow that has established itself in southern Florida.

The black widow spins an irregular, tangled web with a tunnel in the center. The webs are spun in quiet, undisturbed locations that are usually, but not always, close to the ground.

The female spends her life in this web and retreats into the tunnel when disturbed. Her eggs are placed in spherical egg sacs within the web. After hatching, the young spiders stay near the sac for a few hours to several days and then climb to a high point, wait for suitable air currents, and spin a silken thread so they can float on the breeze like a kite. This method of “ballooning” scatters them far and wide. Once they land, the spiders begin to construct their own webs. The abdomen of a young black widow is patterned with red, white, and yellow, but it has black legs and the general appearance of the adult.

## BITES

Black widows are shy, retiring creatures that bite reluctantly and then only in self-defense when threatened. When a female is defending her egg sac, she can be more aggressive. Although the bite may not be felt at first, it soon becomes painful. Symptoms include headache and general body ache, nausea, shortness of breath, intense muscle pain, and rigidity

of the abdomen and legs. An injection of calcium gluconate can relieve the pain. Without treatment, these symptoms usually subside in 2 to 3 days. A black widow bite is more serious for a small child or an elderly person.

## DETECTION AND MONITORING

Monitor for black widows at night with a flashlight or head lamp. This is the time when they move to the center of their webs and will be most visible. When making your inspections, focus on areas that are dark during the day, undisturbed, but not necessarily close to the ground. Look in and around the following places:

- small crevices anywhere from the foundation to the eaves of buildings
- the undersides of outdoor wooden furniture (for example, beneath the seats in the corners where the legs are braced)
- piles of wood, bricks, stones, or similar materials
- the openings of rodent burrows
- water meters
- cellar doors
- outhouses
- storage rooms

Black widow webs have high tensile strength and, with a little experience, can be identified by the way they “pop” when broken. An experienced pest manager can use this information to find webs during the day.

## MANAGEMENT OPTIONS

### Physical Controls

To achieve some kind of permanent control of black widow spiders, you must try to eliminate not only the spiders but also the habitats they prefer, otherwise a new black widow will soon find the same habitat and move in. If black widows regularly build their webs in certain locations indoors, try to modify these areas by increasing the light, caulking crevices, or reducing the insect population the spiders are feeding upon. As mentioned before, check window and door screens for holes that let in insects, and make sure that foods and organic wastes are stored properly to prevent insect infestations. To reduce or eliminate possible web sites outdoors, debris piles and litter should be removed and discarded. All crevices in foundations and walls that are child-height and wide enough to stick a finger into should be caulked closed.

A black widow is easy to crush with a flat stick or similar tool. The spider can be pressed against one of the surfaces to which it has attached its web. You can also crush the spider with your fingers if you are wearing heavy gloves.

## Brown Recluse or Violin Spiders

### IDENTIFICATION AND BIOLOGY

Brown recluse spiders (*Loxosceles* spp.) are identified by long thin legs, an oval-shaped abdomen, a light tan to dark brown color, and a very distinctive violin-shaped mark on the back (see Figure 15-2). This marking gives rise to their other common name, violin spiders.

Their overall size is 3/4 inch to 1 1/4 inches. The males are slightly smaller than the females.

There are many species of brown recluse spider in the United States. They are found mostly in the midwestern and south-central states, the Southwest, and Puerto Rico. As the common name “recluse” suggests, these spiders are similar to black widows: they are shy, retreat when possible, and prefer dark, undisturbed places near or on the ground for their webs. Unlike the black widow, however, brown recluse spiders hunt for insects some distance from their webs. They usually come into contact with humans because they have taken temporary refuge in clothing or bedding. Items left lying undisturbed on the floor, such as supplies, toys, or clothing, are perfect daytime refuges for these spiders. Such objects should be shaken out thoroughly if they have been on the floor for any length of time.

### BITES

Brown recluse spiders avoid areas of human activity. Bites are rare and are usually the result of unused rooms suddenly being put to use, or accidental contact resulting from pressing the spider between the body and either clothing or sheets. The bites are almost always very unpleasant, producing an ulcerous wound called a necrotic lesion that turns dark within a day and takes a long time to heal. Young children, the elderly, and the infirm are most likely to be affected severely. Victims should seek medical attention, but should never allow a doctor to excise the affected tissue.



Figure 15.2  
Brown Recluse Spider

## AVOIDING SPIDER BITES

The three dangerous spiders described in this chapter have particular nesting and hiding places which are described below. If any of these spiders is common around your school, it is important to be cautious when working near these places. Gardeners and custodians should be careful about where they put their hands when doing outdoor work, and wear gloves and a long-sleeved shirt when working around woodpiles and other items stored outdoors that are likely to harbor the spiders.

Make sure students and staff can identify any dangerous spiders in your area and know their likely nesting and hiding places. Children should be taught not to tease spiders in their webs or poke at them, and not to put their hands in dark crevices without looking first. The dangers of spider bites should be explained without exaggeration so no one develops an unnecessary fear of all spiders. Teach students and staff that “black spiders” they see walking around are not likely to be black widows, since the females (males aren’t dangerous) do not travel away from their webs.

### Nesting and Hiding Places for Three Problem Spiders

**Black Widow**—likes dry, undisturbed places such as lumber and rock piles, stacked pots or baskets, rodent burrows, water meters, under bricks and stones, in dry crawl spaces. Females stay in the web.

**Brown Recluse**—likes undisturbed places for its web; hunts primarily at night and will take refuge in clothing and bedding; often found in unused closets and storerooms, behind furniture, and in baseboard cracks and crevices. Outside, it can be found in foundation cracks, cracks in the soil, and window wells.

**Aggressive House Spider**—likes dark, moist places with cracks and crevices for its funnel-shaped web; is a poor climber so is rarely seen above ground level; males wander (especially from June through September) and sometimes become trapped in clothes, toys, bedding, or shoes. Inside, this spider is likely to be found in basements and on ground floors between stored items, in window wells, in closets, and behind furniture. Outside, it can be found in areas similar to both the black widow and brown recluse.

---

## **DETECTION AND MONITORING**

The brown recluse spider wanders at night searching for prey. It seeks dark, uninhabited areas for protection. Brown recluse spiders are usually found on floors and baseboards. Only rarely are they seen on desks and tables and they are never found on walls.

Searches for this spider should concentrate in uninhabited areas close to the floor, particularly in boxes; around piles of paper, clothing, and debris; in closets; and under furniture. Periodic checks outdoors should focus on storage sheds, piles of debris or wood, cracks in the soil or in foundations and walls, and window wells, especially if small children play near those places.

## **MANAGEMENT OPTIONS**

### **Physical Controls**

Because these spiders prefer undisturbed places for nesting and hiding, periodic, thorough cleaning can help reduce their numbers. Floors should be kept well-vacuumed. Boxes of paper and other items stored

in closets, or anywhere else that is dark and undisturbed, should be handled carefully when first inspected. If brown recluse spiders are suspected, the boxes can be placed in a bin-type freezer for 48 hours to kill the spiders before the boxes are unpacked. A small hand-held, battery-powered vacuum can also be used while checking through stored items. If a spider is vacuumed up, the vacuum bag can be slipped into a plastic bag and then placed in a freezer to kill the spider.

Outside, remove piles of debris, wood, and rock. Fill cracks in walls and foundations with mortar or caulk. Inside, clothing and other objects should be removed from floor areas in closets, locker rooms, and other storage spaces. Because most bites are received when putting on shoes or clothing that has lain on the floor, clothes normally stored near the floor should be moved to a higher location. Shake out clothes if they were on a floor overnight. Hanging shoes or placing them in sealed plastic bags reduces the likelihood of being bitten. Wearing leather gloves while searching through stored items can help prevent bites.

## **Aggressive House Spider**

## **IDENTIFICATION AND BIOLOGY**

The aggressive house spider (*Tegenaria agrestis*) is a fairly large (1 3/4 inches, including legs), fast moving spider. Its legs are long and hairy and its body is brown with darker markings on its oval abdomen. This spider builds a funnel-shaped web in moist, dark places. The aggressive house spider waits in the funnel and when it feels vibrations it rushes out to grab its prey.

Spiders mate in the summer and early fall, and females lay eggs in the fall in silken sacs that are placed behind or beside the web. Eggs hatch in the spring and the spiderlings develop for a year before they are sexually mature.

The aggressive house spider is found throughout the Pacific Northwest, Idaho, and Utah.

## **BITES**

Not many people are bitten by this spider and even fewer develop severe symptoms. Bites are most common from July to September when males are wandering in search of females. Often bites occur when the spider is squeezed between clothing and a person's body. The bite of an aggressive house spider can produce symptoms similar to

those produced by a brown recluse. The initial bite is not painful, but within 30 minutes a hard, insensitive area forms around the bite. Other symptoms include severe headache, nausea, weakness, and joint pain. Later, the area blisters, then oozes serum, and eventually scabs over. The lesion can take months to heal.

## **DETECTION AND MONITORING**

The distinctive funnel-shaped web of the aggressive house spider is easy to spot in dark, moist locations at ground level or in basements. Traps made from a cardboard tube about 8 inches long and 1 1/2 inches in diameter coated inside with a sticky material may be useful in detection and possibly control.

## **MANAGEMENT OPTIONS**

### **Physical Controls**

As with the brown recluse, regular, thorough vacuuming behind furniture and stored articles, under baseboard heaters, and in closets will help eliminate habitat. Repair torn screens and broken windows. Make sure doors shut tightly without gaps. If this spider is common in your area, do not store shoes, clothing, or bedding at ground level where spiders could become

---

entrapped in these articles. Outside, caulk holes and crevices in foundations or walls and eliminate as much as possible piles of debris, lumber, and rocks. Cut or eliminate long grass growing near foundations. Wear protective clothing when working outside in areas that might harbor spiders and inspect items that you pick up. Always check articles that you bring into the school from outside storage sheds to make sure you don't bring in spiders or their egg sacs.

## **BIBLIOGRAPHY**

- Akre, R.D., and E.P. Catts. 1992. Spiders. Washington State University Cooperative Extension, Pullman, WA, Bulletin #EB15448, 8 pp.
- Akre, R.D., J. Bruce, and D. Suomi. 1987. Aggressive house spider. Washington State University Cooperative Extension, Pullman, WA, Bulletin #EB1466, 4 pp.
- Bio-Integral Resource Center (BIRC). 1996. 1997 directory of least-toxic pest control products. *IPM Practitioner* 18(11/12):1-39.
- Ebeling, W. 1975. *Urban Entomology*. University of California, Division of Agricultural Sciences, Los Angeles, CA. 695 pp.
- Gertsch, W.J. 1979. *American Spiders*. Van Nostrand Reinhold, Princeton, NJ. 274 pp.
- Hite, J.M., W.J. Gladney, J.L. Lancaster, and W.H. Whitcomb. 1966. Biology of the brown recluse spider. University of Arkansas, Division of Agriculture, Fayetteville, AR, Bulletin 711, 26 pp.
- Olkowski, H. 1991. It's in the wind: learning to welcome beneficial spiders in the garden. *Common Sense Pest Control Quarterly* 7(3):5-11.
- Olkowski, W., S. Daar, and H. Olkowski. 1991. *Common-Sense Pest Control: Least-toxic solutions for your home, garden, pets and community*. Taunton Press, Newtown, CT. 715 pp.
- Roe, A.H. 1993. The aggressive house spider (hobo spider). Utah State University Cooperative Extension, Logan, UT, Fact Sheet No. 86, 4 pp.
- Smith, R.L. 1982. *Venomous Animals of Arizona*. Cooperative Extension Service, College of Agriculture, University of Arizona, Tucson, AZ, Bulletin 8245, 134 pp.



---

# CHAPTER 16

## IPM FOR TREES AND SHRUBS ON SCHOOL GROUNDS

### INTRODUCTION

Across the United States, landscapes vary so greatly that it would be impossible to provide specific management suggestions for all the pest problems on the many trees and shrubs that might be encountered on school grounds. In this chapter we will try to provide a basic framework that will enable you to solve your own problems using information from your specific site. In the Recommended Reading section of this manual you will find several excellent books on trees and shrubs that can help you with specific pest problems.

### PLANT HEALTH CARE MANAGEMENT

Plant health care management (PHC) is a method of managing landscapes that was developed from the concept of integrated pest management (IPM). Many arborists, horticulturists, and landscape managers have long felt that IPM's focus on "pests" is too narrow when it is applied to landscape plants. Probably over half of the problems encountered in landscapes or gardens are not attributable to insects, mites, or disease; instead they are the result of compacted soil, drought stress, overwatering, frost damage, and many other factors. To effectively manage landscapes, plant health and the ecosystem in which the plant is growing must be taken into consideration. PHC takes just this kind of broad approach. PHC incorporates all the principles of IPM, including monitoring, record keeping, and integrating treatments, but PHC emphasizes plant health and proper horticultural practices. PHC is plant management, not just pest management. By focusing only on pests we often overlook the horticultural or environmental factors that affect plant growth and health.

### COMPONENTS OF A PHC PROGRAM

Van Bobbitt, Community Horticulture Coordinator for the Washington State University Cooperative Extension, lists the following 5 components of a PHC program (Bobbitt 1994):

- Know your plants.
- Determine key problems.
- Study your landscape ecosystem.

- Promote plant health.
- Consider a variety of strategies to manage pests.

### Know Your Plants

Before you can properly care for the trees and shrubs on your school grounds, you must know what they are. Make a map of the grounds and identify every tree and shrub. There are books that can help you with this (see the Recommended Reading section), or you can take a specimen to a nursery, the local Cooperative Extension office, or to a landscaping professional.

Once you know the names of all your plants, do some research on each one. Talk to nursery personnel and horticulturists and read about your plants in gardening books. From your research, you should be able to answer the following questions:

- What kind of soil does the plant prefer?
- How much water does it need?
- When should it be fertilized?
- How should it be pruned?
- Does it prefer shade or sun?
- How much heat or cold can it tolerate?
- What are its most common pest problems?
- What environmental problems is it susceptible to (soil compaction, air pollution, salt damage, etc.)?

Your research and your experience can help you to identify key plants that are prone to problems and will therefore need more of your time and attention than other plants. If there are many trees and shrubs on the school grounds, this information can help you focus your maintenance activities. You may also want to use this information to remove plants that are not suited to their sites, that have too many problems, or that require too much care.

### Determine Key Problems

There are many things that can affect the health of a tree or shrub, and they are generally divided into biotic factors and abiotic factors. Biotic factors are living organisms such as diseases, insects, mites, deer, etc. Abiotic factors include maintenance practices (fertilizing, pruning, irrigation), weather, soil quality, amount of sunlight, and human

---

activities such as vandalism or compaction of the soil caused by constant foot traffic. These abiotic factors are probably responsible for a majority of the landscape plant problems.

Determining key problems involves deciding which problems are most likely to affect the health of your plants. Ask yourself if the problem is a serious threat to plant health, a minor threat, or just an aesthetic problem. Again, your research and your experience will help you answer these questions. For instance, one plant disease may kill a tree, but another disease may cause premature leaf drop year after year without seriously affecting tree health.

It is likely that you will have not only key problems, but also key problem sites. For example, perhaps the heavy equipment used in remodeling the school last year has severely compacted the soil in several areas, or perhaps drainage is poor in one corner of the school yard because of heavy clay soil. These sites will need special attention and most likely special plants.

Learn as much as you can about your key problems. If they are living organisms, learn about their life cycles, learn how to identify various stages of the pest and how to recognize symptoms of damage. Do enough research to help you decide which management options are both safe and effective.

If the problems are abiotic, you will need to research these also. Are there specific symptoms that you can learn to recognize? What techniques are available to you for solving the problem? Which solutions can you afford and which are best suited to the particular site? Are there specific plants that can tolerate the problematic abiotic factors?

### **Study Your Landscape Ecosystem**

Your school ground is an ecosystem with complex relationships among the plants, animals, water, soil, sunlight, weather, etc. Because of these complex relationships, there are many things you will need to pay attention to in order to promote plant health. Questions you will need to answer include the following:

- What is your climate? What are the maximum and minimum temperatures?
- Are there micro climates in the school yard that might affect plant growth?
- Where do the prevailing winds come from? Are they unusually strong?

- What are your seasonal patterns of precipitation?
- Where are the sunny and shady parts of the yard? (These will change over time as plants grow and die.)
- What are the characteristics of the soil in each part of the yard?
- What are the drainage patterns?
- What is the history of each area in the school yard? What plants were grown there? (This can be an important factor for some plant diseases.) Was the area covered with asphalt or concrete at some point? Did a road or path go through the site?
- Are animals such as squirrels, deer, and dogs having an impact on the landscape? (The salts in dog urine can be very damaging to plants.)
- What human activities are having an impact on the landscape? Are children vandalizing plants? Are lawns growing right up to the trunks of trees so that mowers regularly damage the trees? Are city de-icing operations salting up the soil?
- What kind of irrigation system is installed in the landscape and is it in working order? Are plants getting too little or too much water?
- Is air pollution a problem in your area? (Air pollution affects plants as well as animals.)

Since landscapes are constantly changing, you will need to monitor frequently in order to detect problems early. Monitor at least every two weeks during the growing season. In mild climates, you should also monitor once a month during the winter. Focus your monitoring efforts on your key plants and your key problems. Be aware that plants growing in poor conditions are under stress and are often more likely to suffer from insects and disease. As you monitor, look for the kinds of damage symptoms you learned about in your research.

### **Promote Plant Health**

Proper plant care is the foundation of a PHC program. Healthy plants mean healthy landscapes, and healthy landscapes have fewer problems and require less special attention. The following points will help you to minimize cultural and environmental problems, as well as pest problems.

- Match the plant to the site. For example, you cannot grow a subtropical swamp plant in a cold dry site. Some plants cannot grow in full sun, and some plants are better adapted to salty or compacted soil or soil with poor drainage. For help with finding plants for

---

your area or for problem sites, talk to local gardening clubs, nurseries, Cooperative Extension personnel or consult books on regional gardening.

- Select pest and disease resistant species.
- Know what kind of care each plant needs and pay special attention to how you water, prune, and fertilize it.
- Plant a diversity of species so that a single pest problem will not devastate your landscape.
- Include “insectary” plants in your landscapes. These are plants that attract and feed beneficial insects with their nectar and pollen, for example, sweet alyssum (*Lobularia* spp.), flowering buckwheat (*Eriogonum* spp.), members of the parsley family (*Apiaceae*) such as fennel and yarrow, and members of the sunflower family (*Asteraceae*) such as sunflowers, asters, daisies, marigolds, zinnias, etc.
- Use proper planting techniques when installing vegetation.
- Improve the soil with organic matter and mulches.

### Consider a Variety of Strategies

If you determine that a problem needs to be treated, it is important to consider a variety of strategies and to integrate those strategies into a comprehensive program. Treatment strategies can be divided into several general categories (each of these strategies is discussed in detail in Chapter 4, Selecting Treatment Strategies):

- **Education.** This can include educating students and teachers about respect for landscape plantings; the more that students can be involved in the planting and care of various portions of the school yard, the less they will vandalize these areas. Education can also involve training maintenance staff in various aspects of plant care and plant selection.
- **Cultural Controls.** These usually include modifying horticultural practices to prevent plant problems or to improve plant health.
- **Biological Controls.** Biological control uses other organisms to combat pests. More and more beneficial organisms are becoming commercially available, and by planting “insectary” plants (see discus-

sion above), you can attract beneficial insects already in your area.

- **Chemical Controls.** Chemicals are not prohibited in a PHC program, but they are used as a last resort, and then they are used judiciously and in the least-toxic formulations. Always spot-treat to minimize the amount of active ingredient used.
- **No Action.** This can be a valid strategy in many situations where the problem does not seriously affect the health of the plant. Your research will help you understand which problems are serious and which are minor or simply aesthetic problems.

### CONCLUSION

PHC is an environmentally sound approach to managing school landscapes anywhere in the country and can result in healthier trees and shrubs that can better withstand the ravages of insects and disease. Although PHC requires time and work coupled with knowledge and experience, the reduction in the use of pesticide along with the long-term benefits to the school landscape will far outweigh these expenditures of time and energy.

### BIBLIOGRAPHY

- Bio-Integral Resource Center (BIRC). 1996. 1997 directory of least-toxic pest control products. *IPM Practitioner* 18(11/12):1-39.
- Bobbitt, V. 1994. Join the plant health care revolution. *Washington Park Arboretum Bulletin* 57(4):12-15.
- Funk, R. 1988. “Davey’s Plant Health Care.” *Journal of Arboriculture* 14:285-287.
- Harris, R.W. 1983. *Arboriculture: Care of trees, shrubs, and vines in the landscape*. Prentice-Hall, Englewood Cliffs, NJ. 688 pp.
- Karnosky, D.F. and S.L. Karnosky. 1985. *Improving the Quality of Urban Life with Plants: Proceedings of the June 21-23, 1983 International Symposium on Urban Horticulture*. New York Botanical Garden, New York. 200 pp.
- Olkowski, W., S. Daar, and H. Olkowski. 1991. *Common-Sense Pest Control: Least-toxic solutions for your home, garden, pets and community*. Taunton Press, Newtown, CT. 715 pp.
- Smith, M.A.L., R.D. Neely, A.G. Endress, R.K. Stutman, and G.R. Smith. 1992. *Plant Health Care: a guide to the plant health care management system*. International Society of Arboriculture Books. Savoy, IL.





---

# CHAPTER 17

## IPM FOR WOOD-DAMAGING PESTS IN SCHOOLS

### INTRODUCTION

The job of maintaining a building includes detecting structural pest problems before they become severe. Early detection means less costly repairs. Although the discovery of wood-destroying insects often generates panic and premature decisions, these pests are slow to cause new damage and there is ample time to accurately identify the pest and decide on an appropriate IPM program. Some of the work can be done by school personnel and the rest contracted out to a professional, or the entire job can be contracted out to professionals.

This chapter will discuss wood-attacking fungi, termites, and wood-boring beetles.

### IDENTIFICATION AND BIOLOGY

#### WOOD-ATTACKING FUNGI

Fungi reproduce from seed-like spores present in the air and soil. Thread-like structures called hyphae grow from the spore and penetrate directly into wood. A mass of hyphae, called a mycelium, is frequently visible on the surface of the wood. A mycelium often takes the shape of a fan or a fluffy mat. Optimal growth occurs at temperatures between 50°F and 95°F on wood containing at least 20% moisture.

The three major groups of wood-attacking fungi are surface-staining fungi (molds and mildews), sap-staining fungi (wood-stains), and decay fungi (wood rots). Surface-staining and sap-staining fungi do not cause loss of structural strength and will not be discussed here; however, they are evidence of moisture problems needing correction. The third group, decay fungi, attack the cellulose and lignin in wood and cause structural weakness. They are hard to detect in their early stages; however, advanced stages are quite evident from the changes in the wood's appearance.

#### Brown Rot

- characterized by white mycelial mats
- causes wood to crack into small cubical pieces perpendicular to the wood grain
- wood rapidly loses its strength and eventually crumbles to powder
- changes the color of the wood to a distinctive brown

#### Dry Rot or Water-Conducting Rot

- relatively rare problem
- a special kind of brown rot most often found in new construction
- can disperse rapidly throughout wood, destroying large amounts in one to two years
- characterized by large, papery, white-yellow mycelial fans
- forms large tubes called rhizomorphs that are up to an inch in diameter and can conduct water to 25 feet
- rhizomorphs are dirty white to black, and grow out and away from the moisture source
- rhizomorphs allow the fungus to extend its growth into dry wood containing less than 20% moisture
- wood surface may appear sound but wavy, even while the interior is heavily decayed

#### White Rot

- makes wood look bleached
- affected wood feels spongy when probed and is stringy when broken
- no abnormal shrinkage
- strength of the wood gradually diminishes

#### Soft Rot

- seldom encountered in buildings, except where wood is in contact with constantly wet soil
- develops in marine habitats in wood that is too wet for other decay fungi
- attacks surfaces of wood and produces a gradual softening inward

### IDENTIFICATION AND BIOLOGY

#### TERMITES

Although there are a number of groups of termites in the United States (including subterranean, drywood, dampwood, and powderpost termites—see Table 17-1), they share some common characteristics. They are social insects and form colonies that contain several castes. These castes differ greatly in their form and function.

During the first six months of the development of a new colony, only 6 to 20 eggs are deposited by the

---

queen. The total number of eggs deposited by a queen varies depending on the termite species (drywood and dampwood queens lay only a few hundred eggs during their lifetimes, whereas subterranean queens can lay tens of thousands). Nymphs hatch in 6 to 12 weeks and are tended by the reproductives. As the nymphs increase in size and number, castes are formed. The worker caste maintains and feeds the colony, and in many species there is a soldier caste that defends the colony. The darkly pigmented, winged reproductive caste (kings and queens) serves only to reproduce and start new colonies. Reproductives “swarm” (fly away from their original colony) only at certain times of the year.

### **Subterranean Termites (*Reticulitermes* spp.)**

Subterranean termites require different ecological conditions from drywood, dampwood, or powderpost termites. Knowing these differences is critical to their successful detection and management.

- Subterranean termites must be in regular contact with moisture, which in most cases means they must stay in contact with the soil.
- In rare cases, they live in the wood above the soil, getting their moisture from a leaky air-conditioner, regular condensation, or some other constant moisture source.
- They construct distinctive earthen tubes to bridge the distance between the soil and wood.
- The passageways protect them from predators and help prevent desiccation as they travel. These tubes are important visible clues to subterranean termite presence.
- Initially, subterranean termites tunnel into soft spring wood, but as the infestation grows, they remove more and more wood until most of it is gone.
- They reinforce their excavations with “carton,” a mixture of wood fragments and fecal material held together by saliva.
- Subterranean termite galleries are coated with a carton-like substance which gives the interior of the galleries a more rough and uneven appearance than other termite galleries.
- Subterranean termites are found in every state, and are responsible for 95% of termite-related damage.

Recently, researchers have discovered distinct differences between northern and southern populations of *R. flavipes*, the eastern subterranean termite. The northern populations are commonly spread by in-

festated firewood, lumber or possibly topsoil, resulting in a patchy distribution pattern similar to Formosan termites (described below). *R. flavipes* in northern areas is rarely seen swarming. As with Formosan termites, northern termites will feed on trees and free standing poles, and they have extremely large colonies that are comparable in size to Formosan termite colonies (up to 2 million individuals). Subterranean termites in the north build extensive shelter tubes on the outside of infested structures and trees.

This new information on northern termites has several implications for control and detection. More buildings must be considered at risk from a single detected infestation of northern termites because of their patchy distribution and large foraging area. Also, monitoring activities should extend to trees, poles, and fences to detect termite activity.

### **Formosan Subterranean Termite (*Coptotermes formosanus*)**

The Formosan subterranean termite was first documented in the United States in 1965. This species is currently found in Hawaii, Texas, Louisiana, Mississippi, South Carolina, Alabama, Tennessee, Florida, and southern California, and is expected to continue aggressively expanding its range.

- The Formosan termite is considered a serious threat in subtropical areas of the United States because it is such an aggressive feeder and has extremely large colonies (2 million to 10 million individuals).
- These termites build nests underground, but they can also nest above ground inside structures.
- A single reproductive pair of *C. formosanus* can result in an extensive infestation within three to five years.
- These termites can chew through the insulation on electrical wire, causing shorts and even damaging 12,000 volt lines.
- They also attack more than 50 species of plants and trees. When trees are attacked and become riddled with tunnels, they lose their structural integrity and are easily blown over in storms.
- Infestations are difficult to locate and control. Chemical control of this insect has been largely unsuccessful.

### **Drywood Termites (*Incisitermes* spp.)**

Drywood termites do not require much moisture. They can attack a structure at points far removed from the soil.

**Table 17-1. Distinguishing Major Termite Groups**

	Distribution	Habitat	Behavior	Appearance
<b>Subterranean termite</b> ( <i>Reticulitermes</i> spp.)	throughout the United States	ground-dwelling in moist sites	builds earthen tubes; does not form fecal pellets; eastern species swarm in April or May, western species usually swarm on warm, sunny days after the first autumn rain	workers and soldiers 1/4 inch long; winged reproductives 1/2 inch long
<b>Formosan termite</b> ( <i>Coptotermes formosanus</i> )	along Gulf and southern Atlantic coasts, Florida, Hawaii, southern California	structural lumber, living plants; can penetrate non-cellulosic materials such as soft metals, asphalt, cracked concrete, and plastic	builds earthen tubes; swarms on warm, sultry evenings especially after rain	soldiers have an oval head with prominent horn-like gland; winged forms pale yellow-brown, similar to drywood termites, with wings about 1/2 inch long
<b>Drywood termite</b> ( <i>Incisitermes</i> spp.)	southern and coastal areas	dry sites including outdoor furniture, firewood and sometimes woody plants (e.g., English walnut, grape, rose, citrus, eucalyptus)	forms oval, six-sided fecal pellets resembling poppy seeds; sometimes expels pellets in sawdust-like piles from "kick-hole" exits in galleries; swarms during the day from July to October depending on the climate	larger than subterraneans but smaller than dampwoods; winged forms and soldiers up to 1/2 inch long
<b>Dampwood termite</b> ( <i>Zootermopsis</i> spp.)	western United States and from British Columbia to lower California	damp, decaying wood, old tree stumps, rotting logs, pieces of buried timber and damp decaying structural lumber	produces large, oval fecal pellets similar to drywood, but flat or concave sides not so prominent; forms only reproductives and soldiers, no workers; swarming peaks in late summer and early fall at dusk	largest termite in the United States; winged forms 1 inch long, with wings twice the length of the body
<b>Powderpost termite</b> ( <i>Cryptotermes</i> spp.)	southern and subtropical areas; occasional invader elsewhere	dry wood, furniture, woodwork, wood floors	forms small fecal pellets	small; soldiers have strongly concave brown or black heads; winged forms 7/16 inch long

the soil. Drywood termites have been the most costly to treat because, until recently, whole-house fumigation was the only treatment. These termites are found in California and the Gulf States.

- Drywood termites usually enter a building through a crack.
- They excavate numerous broad chambers connected by narrow passages.
- The inside of their tunnels is smooth and clean.
- They will tunnel in almost any direction through both spring and summer wood (note that carpenter ants excavate soft spring wood and leave the hard summer wood).
- Fecal pellets are often stored in old chambers, or the termites may drill small, round "kickholes" from the galleries to the outside for expulsion of fecal pellets.
- Piles of these sawdust-like pellets may be the only

---

visible signs of drywood termites. The pellets have a distinctive elongated shape with rounded ends and flat or concave sides separated by six ridges. To see this you will need a magnifying glass.

- Drywood termites cause less structural weakness than subterranean termites.

### **Powderpost Termites (*Cryptotermes* spp.)**

The powderpost termites are tropical pests that can live in subtropical climates such as those found in Florida, Louisiana, southern California, and Hawaii. Although it is uncommon, they may occur elsewhere when brought in accidentally with infested goods imported from the tropics.

### **Dampwood Termites (*Zootermopsis* spp.)**

Dampwood termites are found primarily in the western United States in wet, decaying wood, although they can extend their feeding activities into sound, dry wood.

- These termites are most often found in conjunction with fungal decay.
- In rotten wood their galleries are large and can run across the wood grain.
- In wood that is more sound, dampwood termites make narrower tunnels in the softer spring wood.
- The inside of their galleries has a velvety appearance and is sometimes partially or completely coated with fecal matter.
- An infestation of dampwood termites can usually be controlled by fixing any water leaks that caused the wood to decay and by replacing any rotten wood.

## **IDENTIFICATION AND BIOLOGY**

### **WOOD-BORING BEETLES**

Although some wood-boring beetles can cause serious damage, there is always time to identify the type of beetle present before taking action. When dealing with wood-boring beetles, it is important to know whether or not they will reinfest a piece of wood. Some beetles cannot, and seeing their holes in wood means they have done their damage and left. See Table 17-2 for more information to help you identify some of the most important beetles.

### **Lyctid Powderpost Beetles**

These are small (1/8-1/4 inch), slender beetles that vary from reddish brown to black. Lyctids attack only the sapwood (outer wood) of hardwoods, and are the most common and widespread of the beetles that reinfest wood

in the United States and Canada.

Females lay an average of 20 to 50 eggs in exposed areas of partially seasoned lumber with a high starch content. The hatched larvae bore down the vessels of the wood making straight tunnels which then turn and become irregular. Most species complete their life cycle in 9 to 12 months but they can develop more quickly if the temperature and starch content of the wood are favorable. The larvae pupate near the surface of the wood, and the emerging adults drill a hole through the wood to get out.

You are unlikely to see adult beetles during an inspection, and the larvae are always inside the wood. There is no outside evidence of infestation on wood that has been attacked for only a short time; however, once adult beetles emerge, you will see their small exit holes in the wood. You may also see piles of the fine, flour-like frass (beetle excrement) that sifts from the holes.

### **Anobiid Beetles (sometimes called death-watch or furniture beetles)**

These beetles are small (1/8-1/4 inch), reddish brown to black, and elongate with a very rounded back. In general, beetles in the family Anobiidae are more frequently a problem in coastal areas, unheated dwellings, or wherever the humidity is high. Furniture kept in centrally-heated living spaces is usually too dry for them to infest.

Anobiids attack both hardwoods and softwoods, and will feed on either newly seasoned or older wood. Although they feed mainly on the sapwood, they can also damage heartwood that is close to the sapwood. In the wild, they live in dead tree limbs or in bark-free scars on the trunks.

The females lay their eggs in small cracks or crevices on the surface of the wood. When the larvae hatch, they bore a short distance into the wood, then turn at a right angle and tunnel with the grain. Their tunnels get larger as the larvae grow, and eventually become so numerous that they intersect, and the wood becomes a mass of fragments. Tunnels are packed with fecal pellets from the larvae. It may take two to three years for larvae to complete their development.

Larvae usually pupate in the spring. The newly emerged adults bore holes straight out of the wood, and a large proportion of the females lay eggs in the same wood from which they emerged.

### **Old House Borer (*Hylotrupes bajulus*)**

These beetles are brownish black, slightly flattened, and

**Table 17-2. Characteristics of Damage Caused by Common Wood-Boring Beetles**

TYPE OF BORER	WOOD ATTACKED		RECOGNIZING DAMAGE			Reinfest?
	Part and type	Condition	Exit Holes	Galleries (tunnels)	Frass	
<b>Anobiid powderpost beetles</b>	Sapwood of hardwoods and softwoods; rarely in heartwood	Seasoned	Circular, 1/16 to 1/8 inch diameter	Circular, up to 1/8 inch diameter; numerous; random	Fine powder with elongate pellets conspicuous; loosely packed in isolated clumps of different sizes; tends to stick together <sup>a</sup>	Yes
<b>Bostrichid powderpost beetles</b>	Sapwood or hardwoods primarily; minor in softwoods	Seasoning and newly seasoned	Circular, 3/32 to 9/32 inch diameter	Circular, 1/16 to 3/8 inch diameter; numerous; random	Fine to coarse powder; tightly packed, tends to stick together	Rarely
<b>Lycid powderpost beetles</b>	Sapwood of ring- and diffuse-porous hardwoods only	Newly seasoned with high starch content	Circular, 1/32 to 1/16 inch diameter	Circular, 1/16 inch diameter; numerous; random	Fine, flour-like, loose in tunnels	Yes
<b>Round-headed borers (general)</b>	Sapwood of softwoods and hardwoods; some in heartwood	Unseasoned, logs and lumber	Oval to circular 1/8 to 3/8 inch long diameter	Oval, up to 1/2 inch long diameter, size varies with species	Coarse to fibrous; may be mostly absent	No
<b>Old house borer</b>	Sapwood of softwoods, primarily pine	Seasoning to seasoned	Oval, 1/4 to 3/8 inch long diameter	Oval, up to 3/8 inch long diameter; numerous in outer sapwood, ripple marks on walls	Very fine powder and tiny pellets; tightly packed in tunnels	Yes
<b>Flat oak borer</b>	Sapwood and heartwood of hardwoods, primarily oak	Seasoning and newly seasoned	Slightly oval; 1/16 to 1/12 inch	Oval, up to 1/12 inch long diameter	Fine granules	No
<b>Flat-headed borers</b>	Sapwood and heartwood of softwoods and hardwoods	Seasoning	Oval, 1/18 to 1/2 inch long diameter	Flat oval, up to 3/8 inch long diameter; winding	Sawdust-like, may contain light and dark portions if under bark; tightly packed	No
<b>Bark beetles</b>	Inner bark and surface of sapwood only	Unseasoned, under bark only	Circular, 1/16 to 3/32 inch diameter	Circular, up to 3/32 inch diameter; random	Coarse to fine powder, bark-colored, tightly packed in some tunnels	No
<b>Ambrosia beetles</b>	Sapwood and heartwood of hardwoods and softwoods	Unseasoned, logs and lumber	Circular, 1/50 to 1/8 inch diameter	Circular, same diameter as holes; across grain, walls stained	None present	No
<b>Wood-boring weevils</b>	Sapwood and heartwood of hardwoods and softwoods	Slightly damp, decayed	Raggedly round or elongate, 1/16 to 1/12 inch diameter	Circular, up to 1/16 inch diameter	Very fine powder and very tiny pellets, tightly packed	Yes

<sup>a</sup> In hardwood, pellets may be absent and frass packed tightly.

Adapted from Moore 1995

about 5/8 to 1 inch long. The segment just behind the head is marked by a shiny ridge and two shiny knobs that suggest a face with two eyes. These beetles are very common along the Atlantic coast, particularly the mid-Atlantic states, but because they can be moved around in infested wood, they may become established in other parts of the country.

Despite being called the “old” house borer, this insect is also very common in new construction. This beetle attacks coniferous wood, such as pine, spruce, hemlock, and fir, but it will also feed on hardwoods. The female lays her eggs in cracks and crevices on the surface of wood, and the hatched larvae sometimes crawl around before finding a place through which they can bore into the wood. They remain near the surface, feeding on the sapwood and only gradually penetrating deeper as they grow. They do not feed on heartwood.

The larval period may be completed in two to three years, but it can take as long as 12 or 15 years in dry wood, such as that found in attics. Old house borer tunnels have a distinctive rippled appearance on the inside. Unless the moisture content is high, the tunneling proceeds slowly.

Although this beetle can reinfest wood, the likelihood of this happening in buildings that are occupied, heated, and well ventilated is small.

## DETECTION AND MONITORING

It is important to determine exactly which organisms are present and causing damage before deciding on treatment strategies. The actual damage caused by structural pests (except Formosan termites) occurs slowly over a period of months or years, so there is time to study the situation and make a decision. Correct identification of the pest is critical to determining appropriate management strategies. The diagnostic key in Table 17-3 will help you identify the pest that is causing the problem. Figure 17-1 illustrates some of the major differences between ants and termites, which are often confused with each other. Table 17-1 provides information to distinguish among the major termite groups. Note that in some cases more than one kind of wood-damaging pest may be present.

Table 17-2 describes the major groups of wood-boring beetles and the damage they cause. Wood-boring beetles can be distinguished from one another by the type of frass they produce and the size and shape of the holes they create. It is important to distinguish between those species of beetles that can reinfest wood, causing

extensive damage, and those beetles whose damage is limited to one generation.

If you are uncertain about which pest is present, get a professional identification from the local Cooperative Extension Service or a pest control professional. The time and potential expense needed to correctly identify the pest will be compensated by the fact that you will be able to develop an effective management program for your school.

## Regular Monitoring

Monitoring means looking for signs of damage to the wooden parts of the structure on a regular basis. Information gathered from these regular site inspections should be written down. Include a map of the site with notes about problem areas. Monitoring should show whether a pest problem is getting worse and requires treatment, and whether the treatment has been effective.

Monitoring for structural pests should be regarded as an ongoing responsibility, repeated every one to five years depending on the kind of problems in your area. Early detection of structural pest activity will result in considerably less expensive treatment later.

## School Staff Responsibilities for Monitoring

All personnel responsible for maintaining wooden structures should be trained to identify the conditions that can lead to infestation by wood damaging pests (see the inspection checklist in Appendix I). Box 17-A provides a list of equipment needed for monitoring.

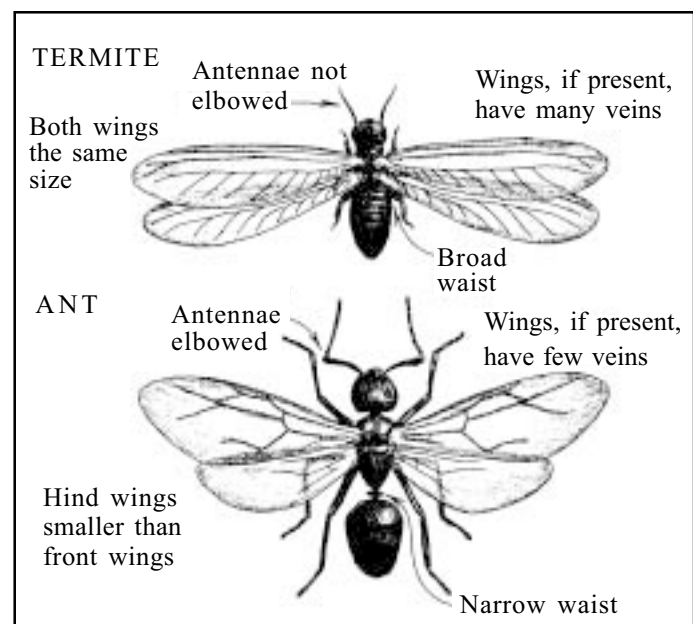

Figure 17-1. Differences Between Ants and Termites

Table 17-3. Diagnostic Key to Wood-Attacking Organisms Based on Symptoms

Fungi: Wood damaged and discolored with shrinkage and/or loss of structural strength. Colored dusty coating on underside of floor, on walls, or on ceilings.	
Specific Symptoms	Probable Cause
Blue stain visible in sapwood.	Blue stain fungus.
Fan-shaped white fungal mat with large 1 inch wide or more white, brown or black thread-like strands (mycelia)	Trametes fungus, or "dry rot".
Soft decayed wood with mycelia and checking (cracking) at right angles to the grain of the wood, particularly on floor or perimeter joists. Wood looks brown and crumbles to a powder when touched.	Brown rot.
White mycelial mass covered with irregular specks or streaks	Forked fungi.

Insects: Holes, tunnels, galleries or chambers on or beneath the surface of the wood.	
Specific Symptoms	Probable Cause
Holes greater than 1/2 inch in diameter.	Carpenter bees.
Holes less than 1/2 inch in diameter	Wood boring beetles.
Galleries or chambers found in wood. The wood surface is easily penetrated with a screwdriver or ice pick.	Termites.
Surface earthen tubes or tunnels running from soil to wood	Subterranean termites
Swarming winged insects at base of fence post, foundation or indoors, or a collection of wings but no insect specimens to distinguish.	Ants or termites (refer to Fig. 17-1 to distinguish). Use Table 17-1 to distinguish termites.
Large bumble bee-like insects flying around exterior near eaves of the house. Some enter large holes. Damage mostly confined to siding or outer boards.	Carpenter bees.
Sawdust or tiny wood scraps on floor	Carpenter ants or drywood termites (see Fig. 17-1)

If monitoring by school personnel indicates signs of termite or wood-boring beetle activity, a more thorough inspection should be made by a pest control professional. These staff members should also be trained to recognize obvious signs of damage, such as those listed under Symptoms in Table 17-3. Although major structural pest management decisions should be based on the recommendations of a trained inspector, having someone on the school district staff who is knowledgeable about structural pests and can supervise outside contractors can improve the quality of pest control and contain costs.

### Using a Pest Control Service

When contracting for structural pest control services, the choice of a company should be based partially on their willingness to provide monitoring services for a fee separate and distinct from treatments. In some parts of

the country it is still common for pest control professionals to offer free termite inspections with the expectation that the inspection cost will be covered by the fees for the treatments that follow. Because there is a potential conflict of interest in having the inspection and treatments performed by the same company, inspection services should be purchased separately. Separate payment increases the likelihood of an unbiased inspection, especially if the inspection and treatment companies are different.

You can use the checklist in Appendix I to confirm the thoroughness of an inspection performed by a professional. A compromise that can save money might involve school personnel checking the relatively accessible areas once or twice a year using this checklist, and hiring a professional (ideally with a termite detecting dog [see below]) to check the harder-to-see places less frequently. Inspect both the inside and the



**Table 17-3. Diagnostic Key to Wood-Attacking Organisms Based on Symptoms**

**Fungi:** Wood damaged and discolored with shrinkage and/or loss of structural strength. Colored stains or dusty coating on underside of floor, on walls, or on ceilings.

Specific Symptoms	Probable Cause
Blue stain visible in sapwood.	Blue stain fungus.
Fan-shaped white fungal mat with large 1 inch wide dirty white, brown or black thread-like strands (mycelia)	Poria fungus, or "dry rot".
Soft decayed wood with mycelia and checking (cracking) at right angles to the grain of the wood, particularly on floor or perimeter joists. Wood looks brown and crumbles to a powder when touched.	Brown rot.
White mycelial mass covered with irregular specks or pocks.	Fomes fungi.

**Insects:** Holes, tunnels, galleries or chambers on or beneath the surface of the wood.

Specific Symptoms	Probable Cause
Holes greater than 1/2 inch in diameter.	Carpenter bees.
Holes less than 1/2 inch in diameter	Wood boring beetles.
Galleries or chambers found in wood. The wood surface is easily penetrated with a screwdriver or ice pick.	Termites.
Surface earthen tubes or tunnels running from soil to wood	Subterranean termites
Swarming winged insects at base of fence post, foundation or indoors, or a collection of wings but no insect specimens.	Ants or termites (refer to Fig. 17-1 to distinguish). Use Table 17-1 to distinguish termites.
Large bumble bee-like insects flying around exterior near the eaves of the house. Some enter large holes. Damage mostly confined to siding or outer boards.	Carpenter bees.
Sawdust or tiny wood scraps on floor	Carpenter ants or drywood termites (see Fig. 17-1)

### Box 17-A. Tools and Safety Equipment for Monitoring Termites

- Flashlight with spare batteries and bulbs
- Screwdriver or ice pick for probing wood suspected of being infested
- Hammer or similar instrument for hitting wood and listening for indications of hollowness
- Ladder for inspecting roof trim and other off-ground areas
- Moisture meter with a range of at least 15% to 24% moisture
- Pencil, clipboard, graph paper, and measuring tape; with these, records can be made precisely on the floor plan or elevation of the building where moisture is evident or wood is damaged
- Tools for opening access entrances into crawl spaces
- Hacksaw blade for checking earth filled porches adjacent to crawl spaces; when inserted under the sill, the thin portion of the blade should not penetrate beyond the sill or headers
- Good-quality caulk, such as silicone seal, and a caulking gun to plug suspicious exterior cracks and crevices; silicone seal is also available in a thinner consistency that can be applied with a brush

outside of the buildings.

If a professional is hired to do the inspection, ask to see examples of sites which were found to have damaged wood. Discovering subterranean termite tubes or beetle damage is not necessarily evidence of an active infestation. Termite tubes or beetle exit holes or frass indicate only that termites or beetles were there at one time. In the case of beetles, the adults that made the exit holes may have been the last beetles that will ever emerge if they are from a species that does not reinfest wood. Treatment of inactive infestations would be an unnecessary expense. Ask for confirmation that living termites or beetles are present, as some companies do not make this confirmation normal practice.

### Detection Techniques for Termites

There are several ways to identify termite activity. The observation of swarming reproductives is an indication of a current termite infestation in the area, but simply finding a pile of discarded wings can be misleading. Winged termites are attracted to light and so could come from other areas. If only swarming insects are seen, a distinction must be made between carpenter ants and

termites (see Figure 17-1). If they are termites, monitoring will determine whether the infestation is from drywood, dampwood, or subterranean termites.

Sometimes you may be able to find “kickholes” made by drywood termites. These holes, 1/16 inch or smaller, are used by drywood termites to eject their sawdust-like fecal pellets from their galleries. These piles of fecal pellets are often the only visible sign of a drywood termite infestation. Wood-boring beetles also make holes in wood and, in some species, fine sawdust-like fecal pellets sift from the holes. Table 17-2 can be used to help identify the pest based on the kind of fecal pellets (frass) left and the kind of hole and tunnels produced by the pest.

The discovery of a mud tube extending from the soil up to the wood is an indication of probable subterranean termite infestation (these tubes are described above under Biology). If only one tube is located, monitoring for other tubes should begin immediately. Break open tubes to see if the termites are active or if the tubes are deserted; an active tube will be rebuilt within a few days. Finding soil in cracks and crevices can also be an indication of subterranean termites.

It isn't always possible to detect damaged wood by looking at the surface. An ice pick can help you probe the wood, and listening for sound differences while pounding on the wood surface can help you find the hollow areas (see Box 17-B).

For many years the only structural pest detection method available was visual observation by trained, experienced pest control inspectors. This method has been further improved by inspection tools such as detection dogs and moisture sensors.

### Termite-Detecting Dogs

The use of termite-detecting dogs is a great advance in inspection methods. Like their bomb- and narcotics-detecting counterparts, these dogs, usually beagles, are specially trained to use their highly developed sense of smell to help their handlers to locate infestations of termites, wood-boring beetles, carpenter ants, and other live, wood-damaging insects. Inspectors use information from the dogs to enhance their own visual and physical inspections.

Termite inspections with dogs cost \$50 to \$100 more than inspections by humans alone, but the cost is usually justified by the increase in thoroughness of the inspection and the added precision in pinpointing sites

of infestation. This added precision can lead to enormous savings by focusing treatment on the site of infestation rather than on the entire building.

### Moisture Meters

A moisture meter will help determine whether or not the moisture content of the wood is high enough to support the growth of wood-inhabiting fungi, wood-boring beetles, or subterranean termites. The needles of the meter should be inserted along the grain of wood to give the most accurate readings. Temperature corrections should be applied to readings taken below 70°F and above 90°F (correction tables are supplied with meters). The meters should not be used in wood treated with water-borne wood preservatives or fire retardants.

### Monitoring Techniques for Formosan Termites

Detection of subterranean Formosan termites (*Coptotermes formosanus*) requires considerable experience, and various techniques may not be equally effective in all areas where the termite has been found.

Box 17-C describes a monitoring trap used in areas like south Florida and Hawaii where aerial infestations of the Formosan subterranean termite in multi-level buildings are prevalent. Light traps are another tool for area-wide monitoring programs, but the cost of a light trap can be expensive. An alternative, developed in South Carolina, uses sticky traps attached to street lamp poles. Studies show that the greatest number of termites was caught 19 feet from the ground. Light traps should be used in the spring during the swarming season. Note that the month in which Formosan termites swarm varies with the area.

### Monitoring for Beetle Infestations

When wood-boring beetle larvae mature into adults inside the wood, they bore exit holes to the surface to get out. Table 17-3 can help you determine what kind of insect created the holes you find. If it is a beetle, the information in Table 17-2 will help to identify the kind of beetle and whether or not it is capable of reinfesting. Consultation with a professional is also advised.

Discovering beetle damage is not necessarily evidence of an active infestation. Signs that the infestation is still active include fresh frass the color of new-sawn

### Box 17-B. The Pick Test

When monitoring your building, use an ice pick or screwdriver to probe wood you feel might be decayed based on its color or other changes you detect. Insert the pick about 1/4 inch into the wood and press sharply downward perpendicular to the grain. If the wood is sound, a long splinter will pull out of the wood along the grain (as shown in the figure below). If the wood is decayed, the splinter will be brittle and break into short pieces across the grain, especially at the point where the pick enters the wood and acts as a lever. You can also detect decayed wood by its lack of resistance relative to sound wood.

Mudsills (wood installed on footings) can be pick-tested without producing excessive visual or structural damage, since they are not visible from outside the crawl space. Sometimes wood treated with a preservative on the surface is decayed inside. The pick test can help reveal these hidden pockets of decay.

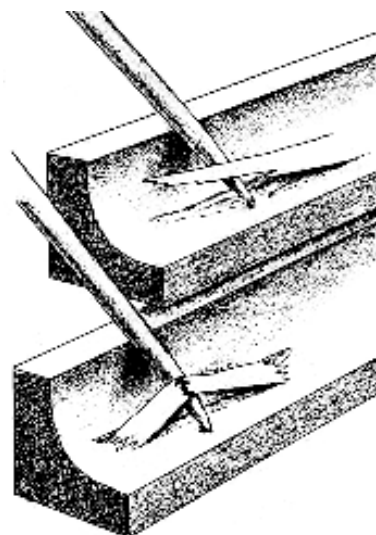

wood and live larvae or adults in the wood. Where you suspect an infestation of the kind of beetles that do not emerge for several years (such as old house borers), you can confirm their presence by listening for the chewing sounds they make inside the wood. To amplify the sounds, use a doctor's stethoscope or the cardboard tube from a roll of paper towels. You can also place a cloth or piece of paper underneath the suspicious area for a week or two to monitor for the fresh debris and frass that are indications of activity for some beetles.

## MANAGEMENT OPTIONS

### Habitat Modification (All Wood-Damaging Pests)

No structural pest control program is complete unless the conditions that favor the survival of the pest are modified. Moisture in or on wood is the single most important predisposing condition for wood damage and structural failure.

#### Reduce the moisture level of the wood

The investment in installing, fixing, or relocating gutters, siding, roofing, vents, drains, downspouts, and vapor barriers will pay for itself in long-term protection against termites, wood-boring beetles, and fungi. Leaking pipes, drains, sinks, showers, or toilets should be repaired. For wood-boring beetles and fungi, often the only control measures necessary are fixing leaks, installing vapor barriers, and using central heating to dry out wood and keep it dry. The most common wood-boring beetles cannot establish themselves in wood with a moisture content below 15%, and the old house borer probably needs more than 10% moisture. Wood must contain at least 20% moisture before it will support the growth of fungi. Few species of fungi can extend their growth into dry wood, and these fungi are relatively rare.

#### Ensure proper drainage under buildings

If the soil under buildings is constantly wet or becomes wet after it rains, this problem should be corrected. Equip downspouts with plastic extensions to direct water away from foundations. Grade the soil around the building to slope gently away from the structure. Installation of a vapor barrier under the building will correct many situations, but more serious moisture accumulations

need other measures. Coat foundation walls with rubberized asphalt membranes to reduce moisture under the building. Extreme cases may require the installation of a sump pump or French drains. French drains are lengths of perforated pipe placed under the soil below the outside foundation footings to catch and drain water away from the building.

#### Improve irrigation or landscape practices to decrease water collection near buildings

Remember that water that falls on the sides of buildings from sprinklers can cause as many problems as natural rainfall.

#### Eliminate direct contact between wood and soil

Ideally, wood should be at least 8 inches above the soil to prevent direct access by subterranean termites and to prevent wood from absorbing excessive moisture. Wood in contact with the soil must be replaced with concrete. If wood is too close to the soil, remove some of the soil and grade it so that it slopes away from the building.

#### Replace damaged wood with treated wood

When wood must be replaced, especially wood in vulnerable areas, it can be treated with borates (see discussion below under Chemical Controls) to protect it from termites and fungal decay. Whenever wood will be exposed to the weather, it is important to paint a water repellent on the bare wood before it is stained or painted. Depending on the product, water sealed wood must dry for a few days to over a month before being painted.

### Box 17-C. Aerial Monitoring for Formosan Termites

Research shows that aerial infestations of the Formosan termite alates (winged termites) can be monitored using a pine board (3.8 x 8.5 x 120 cm) with 31 cylindrical cells (13 x 10 mm) drilled 37.5 mm. apart (Su et al. 1989).

Saw a groove (3.5 mm wide x 5 mm deep) through the center of each cell across the width of the board. Attach a wood cover (1.0 x 8.5 x 120 cm) to the board by two metal hinges and fasten it with two hook-and-eyelet closures. When covered, the grooves provide alates with pathways leading to each cell. Before fastening, sandwich a plate of clear epoxy glass (2.5 x 8.5 x 120 cm) between the board and the cover. When the cover is lifted for observation, the epoxy glass prevents escape of alates. Soak in water for 24 hours before use. Monitor the traps weekly.

Alates trapped on rooftops of multi-story buildings originated either from aerial colonies in nearby buildings or ground colonies. The trap cells can also detect termites, *Cryptotermes* spp., *Incisitermes* spp., and *Reticulitermes* spp. Catching alates means the area is infested. Develop a management prevention program before the next swarming season.

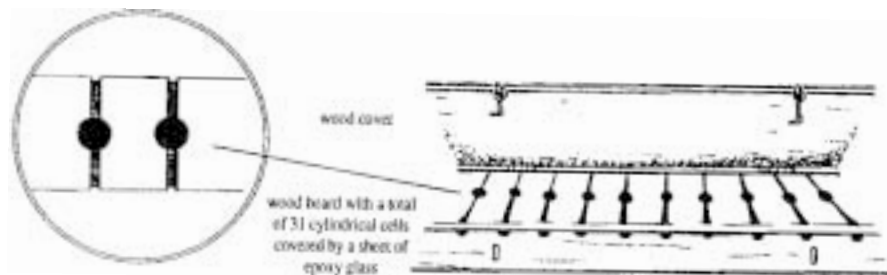

---

Studies show that wood treated in this manner resists weathering and decay many years longer than wood that is only painted or stained.

### **Replace moisture-prone wood with aluminum, concrete, or vinyl**

Sometimes it is more cost-effective to eliminate wood altogether from the most vulnerable areas of the building.

### **Remove tree stumps and wood debris**

Decaying stumps, construction debris, and wood scraps near or under the building can be a source of termite infestation. Remove all wood debris and stumps within 10 feet of foundations. To kill stumps, make a new cut horizontally across the top and a number of cuts vertically into the stump. Immediately rub handfuls of soil into the vertical cuts and cover the stump with a tarp to block out all light. Leave for several months until the stump has decomposed. Never bury wood pieces; they can become termite nesting areas. Small pieces of wood debris containing live termites can be soaked in soapy water to kill the insects. Wood debris containing live termites should be taken to a landfill or other area where the natural decomposing abilities of termites are useful.

### **Store wood piles properly**

Firewood or lumber piles should be constructed so that no wood rests directly on the ground. Use cinder blocks or concrete as a base on which to pile lumber or firewood and inspect the pile periodically. Large piles should be as far from the building as is practical; smaller amounts of wood can be moved closer to the building as they are needed, but do not store logs inside or in a place where they can touch the building or a wooden deck.

### **Plant trees away from buildings**

Because trees and shrubs used in landscaping are often planted when young, a common mistake is to site them too close to a structure. Roots, branches and eventually decaying stumps provide avenues for termite, carpenter ant, and wood-boring beetle infestations. Trees and large shrubs may also provide roof rats, squirrels, and other animals nesting places and access to the upper portions of the building. Leaves clog gutters and can lead to water damage.

### **Screen vents**

Drywood termites also enter buildings through ventilation openings, especially in the attic. Screen vents with window screen instead of the hardware cloth that is commonly used and has much larger openings. Note that

window screen may impede the flow of air through the vents, and the number or size of vents may need to be increased.

### **Maintain buildings in good repair**

The most effective indirect strategy for controlling structural pests is keeping buildings in good repair. Keep the skin of the structure sealed using paint, putty, and caulk. Drywood termites often enter buildings through cracks in eaves or in siding near the roof. Repair cracked foundations by injecting cracks with various materials (patching compounds). Cracks should be chiseled out to a 1/2 inch depth and 3/4 inch width before patching. Injectable bonding materials have some elasticity to resist cracking, whereas cement mixes are likely to crack if soil heaving or settlement is causing ongoing foundation movement.

### **Inspect lumber**

Lumber and other wood items should be carefully examined for wood-boring beetle damage, such as small holes, sawdust, or fine wood fragments, before using or storing. Wooden furniture should be examined carefully for current beetle infestations before placement in the building.

### **Use kiln-dried or air-dried lumber**

Although close visual inspection of wood is essential, it is not a guarantee against beetle infestation. Some infestations can go undiscovered for years before damage is seen. Kiln-dried or air-dried lumber should be used in all construction projects.

### **Physical Controls**

For termites, heavily damaged wood should be replaced with sound wood. Wherever possible, use lumber treated with wood preservatives such as borates (see Chemical Controls below). Dispose of wood as described above under removing tree stumps and wood debris.

For wood-boring beetles, simply removing and replacing infested wood should be the first treatment option you consider. Carefully inspect wood in contact with the pieces that are removed to see if there is further infestation. In some situations this may not be practical because of inaccessibility of the wood or prohibitive labor costs. If any wood has been damaged to the point of structural weakness, it must be replaced or reinforced no matter what treatment is used.

### **Breaking open termite shelter tubes**

---

### **(Subterranean Termites)**

The highly visible earthen tubes of subterranean termites can be broken open easily, or scraped off with a trowel or other instrument and disposed of as described above for wood debris. Once the tubes are opened, natural enemies such as ants can more easily enter the colony and kill the termites. Seal any cracks in the foundation, flooring, or wall that the termite tubes led to, then check back a week or two later. If the tubes have not been rebuilt, the termites are no longer reaching wood at that location; however, it is possible that they will construct new tunnels in inaccessible areas. This is the reason thorough inspections and regular monitoring are essential.

### **Sand barriers (Subterranean Termites)**

Sand barriers composed of grains of sand in a specific size range can be used to prevent subterranean termites from gaining access to a building. UCLA entomologist Dr. Walter Ebeling was the first to show that termites cannot tunnel through a layer of moist or dry sand consisting of particles ranging from 10 to 16 mesh (2.0 mm to 1.2 mm). The range of particle sizes is important because the termites are unable to put their jaws around the larger particles, and the smaller particles pack the spaces in between the larger ones so the termites can't push their heads through. Commercial sand sold for use in sandblasting operations generally contains the required particle sizes; however, confirm with the supplier the mesh sizes in a specific batch of sand before purchasing it for use in termite barriers.

Sand barriers can be used as a remedial treatment under buildings with perimeter foundations and piers or as a preventive treatment under slab foundations before the slab is poured. Sand can also be used around and under fence posts, around underground electrical cables and water and gas lines, beneath and around structural foundation blocks and telephone and electrical poles, inside hollow-tile cells, and as backfill against structural retaining walls. If sand barriers are installed along exterior walls or around fence posts, the sand must be capped with concrete or other material to prevent the sand from blowing or washing away. Around the exterior of a building this can be quite expensive.

Proper installation of the sand barrier is critical to its effectiveness. It is important to carefully smooth the soil before installing the barrier. For perimeter foundations sand is piled to a height of 3 inches next to the foundation or concrete piers, and tapered off over a

horizontal distance of 20 inches. A 4-in layer of sand is necessary under a slab. Sand barriers around perimeter foundations must be monitored regularly in order to detect weaknesses that termites can exploit.

At present, Live Oak Structural in Berkeley, CA is the only company in the continental U.S. commercially installing sand barriers.

### **Heat (Drywood Termites, Powderpost and Wood-Boring Beetles)**

Special equipment composed of a heating unit, blowers, and ducts carries heat to the locations in the structure where the pests are causing damage. In several years of field tests in various parts of the United States, heat treatments have killed insects inside wood without damaging the building or furnishings, although certain sensitive articles and appliances must be removed as a precaution.

An entire structure can be treated with heat but pest control operators generally confine the heat to areas of identified infestations. Temporary containment walls are built inside the building to help focus and contain the heat. Temperature control is critical to success. The inside air is usually heated to around 160°F to attain temperatures on the outside of exposed wood surfaces of 145°F to 150°F. These temperatures allow the inside of the wood to rise to 120°F—a temperature known to kill termites. Large fans are used to mix the heated air, so that the interior of the wood remains at 120°F for 35 minutes.

Since large scale heat treatments are expensive, it is important to have a thorough inspection that can pinpoint infestations. The technique is called Thermal Pest Eradication™, and is marketed by Isothermics, Inc. in Orange, CA. They can supply names of contractors who supply heat fumigation services in your area.

### **Electricity (Drywood Termites)**

A tool called the Electrogun™ can be used to kill drywood termites. The gun shoots pulses of electricity into the wood at low energy (90 watts), high voltage (90,000 volts), and high frequency (100 kHz), killing the insects in their galleries. This tool is safe for the operator and emits no microwaves, X-rays, or ultraviolet rays. In most cases it does not require any special preparation of the structure, nor relocation or inconvenience to the client. There are drawbacks to the Electrogun which include the necessity of the wood being accessible and the limitations

---

of the device that allow its use on only about 60 to 70% of existing structures. Although it will not damage wires, wirewound motors, refrigerators, or washing machines, computers and other electronic equipment must be unplugged and moved three feet away from walls.

Etex, Ltd. in Las Vegas, NV manufactures the Electrogun and can identify operators in your area who are trained to use the tool. Operators must learn how to use it properly, and training is provided by the distributors.

### **Microwaves (Drywood Termites)**

Microwave irradiation is commercially available in some areas for spot treatment of drywood termites. This method relies on the high water content of termites which makes them heat up faster than the surrounding wood when they are exposed to microwaves. If the internal temperature of the termite is elevated sufficiently, the insect will die just as it does during heat treatment.

### **Extreme cold (Drywood Termites)**

Extreme cold in the form of liquid nitrogen can be used to kill drywood termites. It is applied commercially as “The Blizzard System” by Tallon Pest Control (Union City, CA) in parts of California and Nevada and can be used only in wall voids.

The pest control operator must know the approximate extent of the termite infestation in order to inject liquid nitrogen into the proper areas, but the material can reach areas of buildings not accessible to other treatment methods. For example, infestations embedded too deeply in wood to be accessible to chemical “drill and treat” methods, or wall voids containing metal lath which interferes with the Electrogun can be treated with liquid nitrogen.

### **Biological Controls**

The fungus *Metarhizium anisopliae* has recently been formulated into a microbial pesticide that is effective against a number of termites including subterranean termites such as *Reticulitermes* spp., *Heterotermes* spp., and *Coptotermes formosanus* (the Formosan termite), drywood termites such as *Incisitermes* spp. and *Kaloterms* spp., dampwood termites such as *Zootermopsis* spp., and powderpost termites such as *Cryptotermes* spp. (This same fungus is used in cockroach bait stations.) The fungus is extremely infectious among termites and is spread in the termite colony by direct contact, grooming, and trophallaxis (the exchange of alimentary fluids). It causes death

within 8 to 11 days.

The fungus is currently formulated as a dust or wettable powder that must be applied where termites will come into contact with it. This means it can only be sprayed into active termite galleries. Initial studies indicate that only 5% of the termites have to encounter the fungus directly to kill the entire colony, although this number will probably vary depending on the termite species and the environmental conditions. Since it cannot grow at temperatures greater than 95°F, the fungus does not infect humans or other mammals.

### **Chemical Controls**

If non-chemical methods alone prove insufficient to solve the problem, then integrating a pesticide into your management program may be warranted. For information on the hazards of various pesticides and on how to select an appropriate pesticide for your situation, consult Appendix G for a list of resources.

Pesticides must be used in accordance with their EPA-approved label directions. Applicators must be certified to apply pesticides and should always wear protective gear during applications. All labels and Material Safety Data Sheets (MSDS) for the pesticide products authorized for use in the IPM program should be maintained on file. Do not apply these materials when buildings are occupied, and never apply them where they might wash into the sanitary sewer or into outside storm drains.

Always post durable signs where pesticides have been used in attics and crawl spaces so that future inspectors and repair technicians can identify and avoid the materials if necessary.

If insecticides are used, spot treatment is recommended to reduce human exposure. Spot treatment in this case refers to the application of the insecticide to only those areas where structural pests have been detected or areas that are not accessible for monitoring. Standard practice is to apply long-lasting pesticides in all areas where structural pests might conceivably become established. With a good monitoring program in place, it should not be necessary to use broad-scale applications of insecticides. If insecticides are used, they are most effective when combined with physical controls such as habitat modifications, wood replacement, heat treatments, and electrical treatments.

### **Borate-based wood treatments (Subterranean and Drywood Termites, and Wood-Attacking Fungi)**

---

Borates are fungicides and slow-acting insecticides. They are not repellent to insects (termites will construct tubes over borate-treated wood), but do act as anti-feedants, which means that pests prefer not to feed on wood treated with borates. When insects feed on wood treated with borate or, in the case of wood-boring beetles, chew emergence holes through treated wood, the borate acts as a stomach poison to kill the insects over a number of days. As fungicides, borates act by inhibiting the growth of wood-attacking fungi.

Borates are used both in the pre-treatment of lumber for the construction industry and in remedial treatment of lumber in existing buildings. Pre-treated lumber can be used to replace existing lumber to prevent reinfestation in areas of potential termite activity or in areas vulnerable to rot. Crawl spaces and attics can be treated by a professional using a borate fogger, by spraying or painting liquid solutions directly on the wood, or by pressure injecting the solution into the wood. A larger amount must be used in a fogger to get the same coverage as painting or spraying on the solution. Borates can be effective as an insecticide to eliminate small termite and wood-boring beetle infestations.

Since borates are water soluble they cannot be used to treat exterior wood unless a finish (paint or stain) or sealant is subsequently applied to the wood. Since borates can move easily through the soil and leach away from the area of application, they should not be used in close proximity to lakes, streams, ponds, or areas where there is standing water. High concentrations of borates are toxic to plants, so treatments of the perimeter of buildings can result in inadvertent poisoning of plants and shrubs near the building.

#### **Desiccating dusts such as diatomaceous earth and silica gel (Drywood Termites and Wood-Boring Beetles)**

Desiccating dusts can help in preventing future infestations of drywood termites and wood-boring beetles. They are particularly useful in confined spaces such as attics and wall voids where they can remain effective for the life of the building. Desiccating dusts alone are effective and safe. They act primarily as physical, not chemical, agents but are commonly combined with pyrethrins.

Desiccating dusts act by absorbing the oily or waxy outer layer that coats the body of an insect. Water inside an insect is contained by this waterproof coating, and loss of the coating causes the insect to die from dehydration.

Diatomaceous earth has been used against termites as a repellent, but the use of silica gel for termite control is

more common. Diatomaceous earth can be easier to handle because it is composed of larger particles than the silica gel. It is important to note that the product described here is not the glassified diatomaceous earth used for swimming pool filters, but rather “amorphous” diatomaceous earth.

These dusts are effectively used during construction to prevent infestations of drywood termites, but can also be blown into attics and wall voids as a remedial treatment. They can be applied over a small or large area. Examples of sites where desiccating dusts are useful are areas where condensation or poor drainage cannot be corrected, where wood cannot be moved far enough above the soil level, or where physical access for monitoring is limited, such as wall voids, crawl spaces, and attics.

If dusts are applied on a large scale, it is best to use special (but readily available) pressurized application equipment. Whenever dusts are applied, use a dustmask and goggles to avoid breathing the material and getting it in the eyes.

#### **Synthetic pyrethroids (Subterranean and Drywood Termites)**

Synthetic pyrethroids are coming into wider use as termiticides. Studies have shown that cypermethrin, fenvalerate, and permethrin are more toxic and more repellent to eastern subterranean termites than is chlorpyrifos (Su et al. 1990). Cypermethrin is by far the most toxic, and although permethrin is somewhat less toxic to termites than cypermethrin, it is capable of repelling them at the lowest concentrations. Note, however, that pyrethroids cannot repel termites at a distance because of their low vapor pressure (their vapors do not move far into the soil); termites must come into direct contact with the treated soil to be repelled.

Using insecticides as termite barriers in the soil relies on uniform distribution in the soil; however, in some cases soil characteristics may prevent this and barriers will fail.

Termiticides can also be applied as a foam to more effectively coat hard-to-reach surfaces. This can be particularly useful when treating a slab where the underlying soil has subsided or washed away. Injections of liquid pesticide may not coat all vulnerable surfaces, especially the underside of the slab. Because the foam fills the void, it leaves a residue on all surfaces.



---

### **Termite baits (Subterranean Termites)**

The termite baiting strategy involves two steps: attracting termites and then exposing them to a slow-acting toxicant. The toxicant must be slow-acting so that termites have time to go back to the nest to spread the toxicant among their nest mates through food sharing and through mutual grooming. Since termites habitually wall off members of the community and/or galleries when they sense a problem with their food supply, the toxicant must work slowly enough that it goes undetected until a good portion of the colony has been exposed.

Baiting can eliminate a termite colony over a number of months (conventional chemical barrier treatments only try to prevent termites from entering a structure), but elimination may not be practical or necessary. Adequate control can probably be achieved by reducing the colony enough that no termites are seen in structures and no PCO call-backs are necessary (Ballard 1995).

### **Safety of Baits**

Much smaller amounts of active ingredient are used in baits than are used in chemical barrier treatments so there is less of a risk of contamination by the poison. Most of the toxicants that are used in termite baits have low acute toxicity, and the concentrations in which they are used are generally low. Manufacturers are designing bait stations to be self-contained and tamper-resistant to protect children and animals from accidental exposure.

### **When to Bait**

Because termite activity is seasonal, baiting is more effective at certain times of the year than other times. The best time to bait the eastern subterranean termite (*R. flavipes*) is in the late spring and early summer. The western subterranean termite (*R. hesperus*) can probably be baited year around, but the best results will be obtained in June, July, and August.

### **Two Types of Baiting Strategies**

There are two general types of food baiting that can be used: perimeter baiting or interceptive baiting. If the whereabouts of the termites are unknown, perimeter baiting is used. Wooden stakes, bait blocks, or plastic monitoring stations are set around the perimeter of a structure either in a continuous circle or in a grid pattern. Perimeter baiting relies on the certainty that termites foraging at random will eventually discover the bait. Once termites have been located, either by perimeter baiting or by finding shelter tubes or active galleries, interceptive baiting can be used. Here, actively foraging termites are intercepted with a toxic

bait. Interceptive baiting of structures has the disadvantage that quite often termite damage has already been done, and even though the colony is eliminated, the wood may have to be replaced.

### **Three Bait Toxicants**

At this writing, only three toxicants are being used commercially for baiting termites.

**Sulfluramid.** Sulfluramid is currently registered as an above-ground bait toxicant and cannot yet be used below ground. The tamper-resistant bait stations contain a food bait treated with sulfluramid. Sulfluramid acts by biochemically blocking the termite's ability to respire causing death by suffocation. Only tiny amounts of sulfluramid are necessary. Currently, sulfluramid bait stations are only being produced by FMC Corporation under the product name First Line®.

For inside infestations, the mud shelter tubes need to be located and broken into at the leading edge where a bait station is then attached with tamper-resistant screws. For outside infestations, bait stations can be placed near fenceposts, in wooden mulches, and in other areas where termite infestation is likely.

**Hexaflumuron.** Hexaflumuron is currently registered as a below-ground bait toxicant. It is a chitin-synthesis inhibitor that stops termite development by preventing the insects from producing chitin, the substance that makes up their exoskeleton or "skin." Termites must produce a new exoskeleton each time they molt (grow) which is every 1-2 months; therefore, a toxicant that interferes with molting could kill an expanding termite colony over a period of 3 months.

Currently, hexaflumuron is being manufactured into termite bait stations only by DowElanco. The bait stations are being marketed as one part of a 3-step process (the Sentricon® System) that involves detection, elimination, and continued monitoring. The stations, which are perforated plastic cylinders, are buried in the ground every 10 to 20 feet around the perimeter of the building. The cylinders are first filled with wooden monitoring blocks, but when the termites are found, the blocks are replaced by bait tubes. Once termites are no longer feeding on the bait, monitoring with wooden blocks continues in order to detect any new invasions.

**Hydramethylnon.** Hydramethylnon is registered for underground use in termite bait stations, but it is also

---

used in fire ant and cockroach bait stations. This toxicant works as an insect stomach poison. At this writing, hydramethylnon is formulated into a toxic termite bait only by Cyanamid for use in their patented bait stations (called the Subterfuge™ Termite Bait System). The bait stations are placed in the ground at least every 20 feet. If there is a known infestation, they are placed every 10 feet, and if termites are found entering a building, two or three bait stations are placed around the entry point. The stations can be opened to replenish bait without removing them from the ground so that termite feeding tunnels are not disturbed and the termites are less likely to abandon the station. After termites have stopped feeding on the bait, the stations can be left in the ground to monitor for new infestations.

## BIBLIOGRAPHY

- Beal, R.H., J.K. Mauldin, and S.C. Jones. 1983. Subterranean termites: their prevention and control in buildings. U.S. Forest Service, Washington, D.C. Home and Garden Bulletin 64. 36 pp.
- Bio-Integral Resource Center (BIRC). 1996. 1997 directory of least-toxic pest control products. *IPM Practitioner* 18(11/12):1-39.
- Ballard, James. 1995. Personal Communication. Technical Manager, FMC Corporation, P.O. Box 8 Princeton, NJ 08543.
- Brown, R.W. 1979. Residential Foundations: Design, behavior and repair. Van Nostrand Reinhold, New York. 99 pp.
- Daar, S. and W. Olkowski. 1985. Moisture management: Key to protecting your home. *Common Sense Pest Control Quarterly* 1(4):13-21.
- Ebeling, W. The Extermax System for Control of the Western Drywood Termite, *Incisstermes minor*. Etex Ltd, Las Vegas, NV. 11 pp.
- Ebeling, W. 1968. Termites: Identification, biology, and control of termites attacking buildings. California Agricultural Experiment Station Extension Service (Manual 38), Berkeley. 74 pp.
- Ebeling, W. 1975. *Urban Entomology*. University of California Publications, Los Angeles. 695 pp.
- Ebeling, W. 1994a. The thermal pest eradication system. *The IPM Practitioner* 16(2):1-7.
- Ebeling, W. 1994b. Heat penetration of structural timbers. *The IPM Practitioner* 16(2):9-10.
- Ebeling, W. and C.F. Forbes. 1988. Sand barriers for subterranean termite control. *The IPM Practitioner* 10(5):1-6.
- Forbes, C.F. and W. Ebeling. 1986. Liquid nitrogen controls drywood termites. *The IPM Practitioner* 8(8):1-4.
- Forbes, C.F., and W. Ebeling. 1987. Use of heat for elimination of structural pests. *The IPM Practitioner* 9(8):1-5.
- French, J.R.J. 1991. Baits and foraging behavior of Australian species of *Coptotermes*. *Sociobiology* 19(1):171-186.
- Grace, J.K. 1989. Northern subterranean termites. *Pest Management* 8(11):14-16.
- Grace, J.K. 1991a. Behavioral ecology of subterranean termites and implications for control. In: *Proceedings of the symposium on current research on wood-destroying organisms and future prospects for protecting wood in use*. USDA General Technical Report PSW-128. Pacific Southwest Research Station, P.O. Box 245, Berkeley, CA 94701.
- Grace, J.K. 1991b. Termite-fungal associations and manipulations for termite control. In: *Program and Abstracts, 24th Ann. Meeting of the Society for Invertebrate Pathology*.
- Grace, J.K., A. Abdallay, and K.R. Farr. 1989. Eastern subterranean termite (Isoptera: Rhinotermitidae) foraging territories and populations in Toronto. *Canadian Entomologist* 121:551-556.
- Herbertson, R. 1991. Construction epoxies, how they work, what they're used for and how to use them. *Fine Homebuilding* Oct./Nov.:45-49.
- Hickin, N.E. 1971. *Termites, a World Problem*. Hutchinson and Co., London. 232 pp.
- Levy, M.P. 1975. *A Guide to the Inspection of New Homes and Houses under Construction for Conditions which Favor Attack by Wood-inhabiting Fungi and Insects*. U.S. Department of Housing and Urban Development, Washington, D.C. 42 pp. [Available from: HUD User, Document 1083, P.O. Box 280, Germantown, MD 20767.]
- Levy, M.P. 1975. *A Guide to the Inspection of Existing Homes for Wood-Inhabiting Fungi and Insects*. U.S. Department of Housing and Urban Development, Washington, D.C. 104 pp.
- Moore, H.B. 1995. *Wood Destroying Insects*. *Pest Control Magazine*, Cleveland, OH. 120 pp.
- Olkowski, W., S. Daar, and H. Olkowski. 1991. *Common Sense Pest Control: Least-toxic solutions for your home, garden, pets and community*. Taunton Press, Newtown, CT. 715 pp.
- Potter, M.F. 1994. The coming technology: a wild ride. *Pest Control Technology* 22(10):35-45.
- Quarles, W. 1995. Least-toxic termite baits. *Common Sense Pest Control Quarterly* 11(2):5-17.
- Scheffer, T.C. and A.F. Verrall. 1973. Principles for protecting wood buildings from decay. U.S. Department of Agriculture, Washington, D.C. Forest Service Research Paper FPL 190. 56 pp.
- Su, N.Y. and R.H. Scheffrahn. 1990. Potential of insect growth regulators as termiticides: a review. *Sociobiology* 17(2):313-325.
- Su, N.Y. and R.H. Scheffrahn. 1993. Laboratory evaluation of two chitin synthesis inhibitors, hexaflumuron and diflubenzuron, as bait toxicants against Formosan and eastern subterranean termites (Isoptera: Rhinotermitidae). *Journal of Economic Entomology* 86(5):1453-1457.
- Su, N.Y., R.H. Scheffrahn and P. Ban. 1989. Method to monitor initiation of aerial infestations by alates of the Formosan subterranean termite (Isoptera: Rhinotermitidae) in high-rise buildings. *Journal of Economic Entomology* 82(6):1643-1645.
- Su, N.Y., R.H. Scheffrahn, and P. Ban. 1990. Measuring termiticides. *Pest Control* September: 24,30-36.
- Weesner, F.M. 1965. *The Termites of the United States*. The National Pest Control Association, Dunn Loring, VA. 68 pp.
- Wood Protection Council. 1988. *Guidelines for Protection of Wood against Decay and Termite Attack*. National Institute of Building

---

Sciences. 27 pp.

Young, E.D. 1976. Training Manual for the Structural Pesticide  
Applicator. EPA, Office of Pesticide Programs, Washington,  
D.C. 168 pp.



---

# CHAPTER 18

## IPM FOR WEEDS ON SCHOOL GROUNDS

### INTRODUCTION

A “weed” is commonly defined as a plant growing in a place where it is not wanted. Plants can be unwanted because they compete with desired species, because they cause harm to people or structures, or because their appearance or odor is offensive. The designation “weed” can be quite subjective; for instance, the dandelion can be considered a weed in one setting and a wildflower or culinary herb in another.

On school grounds, there is usually consensus on the weedy nature of certain plant species such as thistles, docks, crabgrass, and poison oak or ivy that spring up where they are not wanted. These species have common characteristics that enable them to “take over” when conditions are right. By understanding conditions suited to weed growth, landscapes can be designed and maintained in ways that minimize such conditions, and the need for herbicides can be reduced or eliminated. The goal is to encourage desirable plants to out-compete weeds in habitats where plant growth is acceptable (shrub beds, turf areas, tree wells, student gardens), and to remove conditions conducive to weeds in areas where vegetation is not wanted (in pavement cracks, on running tracks, under fences). A review of basic principles of weed biology and ecology will help identify conditions that promote weed growth and suggest methods for encouraging competitive desirable vegetation and discouraging weeds. (Note that the management of weeds in turf is discussed in Chapter 10.)

### IDENTIFICATION AND BIOLOGY

Weeds can be found among both broadleaf plants and grasses. Like all plants, weeds are classified within three general categories according to the duration of their life cycle and their methods of reproduction.

**Annuals.** These are the most common weeds; they live one year and reproduce by seed. These plants have a rapid life cycle that enables them to germinate, shoot up, blossom, set seed, and die within the space of a few weeks or months. Their rapid life cycle allows them to thrive on a minimum of nutrients and water.

**Biennials.** These weeds live two years, and reproduce both vegetatively and by seed.

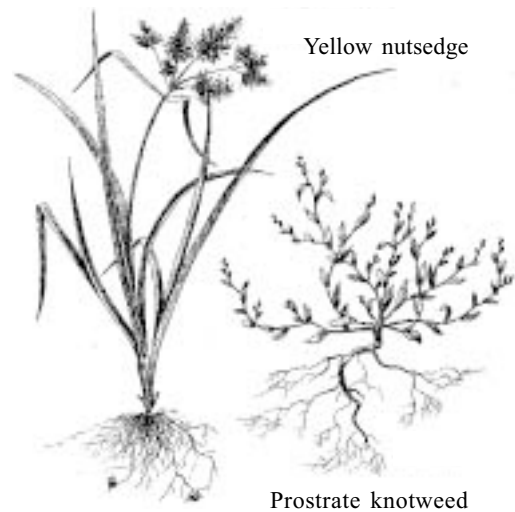

**Perennials.** These weeds live more than two years. Although perennials produce seeds, their main means of reproduction is usually vegetative, for example, by forming new plants from bulbs or corms, or by producing new top growth from buds located on underground stems (rhizomes).

### Weed Habitats

Weeds tend to grow in places where the soil is bare or disturbed:

- areas that have been cultivated (shrub and flower beds, etc.)
- trampled or close-mowed lawns
- unpaved play areas and paths
- sports fields
- fence lines
- graded roadsides
- cracks in sidewalks or other pavement
- areas where the same herbicide has been used repeatedly and plants tolerant to that material have moved in

Weedy areas found on school grounds tend to be hot, dry, unshaded habitats—often with low nutrient levels and soil moisture. Certain plants such as thistles, knotweeds, plantains, barnyard and crab grasses, etc. have evolved to take advantage of these conditions. As they grow, die, and decompose, the soil is stabilized, erosion is reduced, and the soil environment becomes more moist and fertile. Under these im-

---

proved conditions, plant species with less-weedy characteristics will eventually displace the weeds. Thus a meadow left undisturbed may eventually become a forest.

## **DETECTION AND MONITORING**

The purpose of monitoring is to determine if, when, where, and why weeds are growing or posing a problem, and to assign priorities for habitat change and least-toxic weed suppression. The components of effective weed monitoring are described here.

### **Mapping Weed Habitats**

The first step in monitoring is to map areas where weeds are growing. This need not be a detailed, time-consuming process—a rough map will do. For areas to monitor, see the list under “Weed Habitats,” above.

### **Identifying Weed Species**

It is important to accurately identify the most common weed species on your school grounds in order to determine appropriate management methods. Knowing the scientific name of the weed makes it much easier to obtain information from research professionals and the scientific literature. Assistance is available from Cooperative Extension Service literature and personnel, or pictorial weed guides. A quick and effective method for preserving weed samples using plastic-covered index cards is described in Appendix F. This simple method results in a portable, easy-to-use weed reference.

Learn about the growing conditions required by the weed as well as its growth characteristics and methods of reproduction. Weeds can be indicators of soil conditions that need to be changed to discourage weed growth. For example, yellow nutsedge (*Cyperus esculentus*) indicates excessive water perhaps due to a broken irrigation pipe or valve. Conversely, prostrate knotweed (*Polygonum aviculare*) indicates dry, compacted soil requiring aeration and addition of organic matter. By changing the conditions indicated by the weed, these unwanted plants can be discouraged from growing.

### **Record Keeping**

It is important to record the time of year a particular weed species appears, its abundance, and its impact on the landscape. This information will help determine

- which weeds and how many of each can be tolerated in a specific area without the weeds impairing the function of the landscape or its aesthetic appeal

- whether or not management strategies are effective
- whether weed populations are rising, falling, or staying about the same from year to year
- whether new species of weeds are becoming a problem (this often happens as a result of weed control efforts)

Without this information, it is impossible to determine the long-term effectiveness of management methods.

### **Establishing Weed Tolerance Levels**

School landscape maintenance budgets rarely stretch far enough to suppress all weeds, even if that were desirable. Aesthetic standards should be adjusted to take this into account. Assigning tolerance levels helps prioritize budget allocations, facilitate long-term plans, and provide justification for weed management action—or lack of action.

Identify areas where weeds pose potential health or safety hazards or threaten damage to facilities, and distinguish these locations from those where weeds are considered aesthetic problems alone. For example, poison oak or ivy can cause severe skin rashes and itching, and weeds growing in playing fields or running tracks can pose tripping hazards. Assign low tolerance levels to weeds in such areas, and place high priority on their management. On the other hand, assign higher tolerance levels to weeds growing in shrub beds or along fence lines and lower priority for management.

Since most weed tolerance levels are subjective, one way to establish them is to invite a representative group (e.g., the school principal, coach, landscape maintenance supervisor, PTA officer, teacher, student, and parent) to tour the school grounds and decide where weed levels are acceptable and where they are not. It is important that this group reach consensus on overall weed management objectives for various school sites, and that weed tolerance and action levels derive from this agreement. Weed tolerance levels can be re-evaluated on an annual basis.

### **Long-Term Weed Management Plans**

Long-term plans should focus on making changes to the habitat to permanently exclude weeds in areas where weed tolerance levels are low. In some cases this may require augmented budget allocations. By developing plans, budget needs can be spread over several years.

### **Evaluation of Weed Management Programs**

The availability of herbicides has often helped perpetuate

---

poor landscape designs and inappropriate maintenance practices because herbicides could be used to compensate for them. By gathering monitoring data, the underlying causes of weed presence can be pinpointed. The data can be used to change design specifications for landscapes, sport fields, playgrounds, and pavement to avoid encouraging weeds.

The long-term costs, risks, and benefits of various weed management approaches should also be evaluated. A one-time cost to install concrete or asphalt mow strips under backstops and fence lines and thereby permanently remove weed habitat may be less costly in the long run than repeated herbicide use that may pose a potential health risk, resulting in lawsuits and poor public relations.

## MANAGEMENT OPTIONS

### Horticultural Controls

This approach involves manipulating plant selection, planting techniques, and cultural practices so that desired vegetation grows so densely and vigorously that weeds are crowded out.

Planting beds can be rototilled and irrigated to force weed seeds to germinate. As soon as sprouted weeds appear as a “green fuzz” on top of the soil, they can be killed by a second cultivation with the tiller set at 1 inch. Shallow cultivation prevents weed seeds from being moved to the top 2 inches of soil—the germination range. This will reduce weed growth while ornamental plants are becoming established.

### Plant Selection

In shrub beds, you can include groundcovers with rapid, spreading growth habits that can out-compete weeds.

### Competitive Interplanting

When shrubs or groundcovers are installed, the spaces between individual plants are often colonized by weeds before the ornamentals can spread and shade them out. These weed habitats can be eliminated by overseeding newly planted areas with fast-growing annual flowers such as sweet alyssum (*Lobularia maritima*), farewell-to-spring (*Clarkia amoena*), and scarlet flax (*Linum grandiflorum* var. *rubrum*).

### Mulching

Mulches are primarily used to exclude light from the soil, thus limiting weed seed germination. Mulches can be composed of organic materials (compost, wood chips, etc.), stones or gravel, or synthetic landscape fabric.

Landscape fabric is preferred over black plastic, because it allows air and water to move through the soil to benefit ornamental plant roots, but excludes light at the soil surface to thwart weeds.

To be effective, mulches should be applied immediately after plants are installed. Bark or compost mulches should be 3 to 4 inches deep to exclude light. If landscape fabric is used, it should be covered with an inch or two of bark, stones, etc. to improve the aesthetic appearance of the planting area and reduce degradation of the fabric by sunlight. Landscape fabric can last for years if properly maintained.

### Physical Controls

Hand-pulling, cultivation, and use of string trimmers and mowers are very effective weed control techniques. If labor is in short supply, make good use of parent and student volunteers, community service groups, and youth groups. Classrooms can adopt a flower bed or a section of the school yard to maintain and beautify. If students are involved in grounds maintenance, they will be more careful of the plants and take pride in a clean, well-maintained school yard.

Weeds on baseball infields, running tracks, and other bare soil areas can be suppressed by periodic shallow cultivation with a tractor-mounted rotary harrow, also called a rotary hoe or power rake (Rhay 1994). In areas with heavy clay soils, this method can be combined with addition of sawdust to reduce the crusting and puddling characteristics of these soils.

### Eliminate Weed Habitat

Creating a “mow strip” under and immediately adjacent to fence lines can solve a common weed problem. When fences surround paved playing surfaces such as basketball courts, the steel fence posts can be installed directly into the paving material, 8 to 12 inches to the inside of the paving edge. The paving prevents weeds from growing under or adjacent to the fence, and provides a paved strip for the wheel of a mower which can keep adjacent grass trimmed. The strip also provides access for use of string trimmers when shrub beds abut the fence line.

Existing cyclone fence lines can be modified by pouring a 16-inch wide concrete or asphalt strip to cover the soil under and beside the fence. This retrofit can be performed in stages over several years as budgets permit. The one-time paving cost will produce many years of

savings in weed control.

Use asphalt or cement crack filler to fill cracks in paved areas where weeds are a problem.

### Flaming

Flamers are used by a growing number of parks and school districts to treat weeds in pavement cracks, under picnic tables and benches, along fence lines, etc. This technique utilizes a small gas- or propane-fired torch to sear the tops of young weeds. The heat raises the temperature of the sap in the plant cells, the cell walls rupture, and the weed wilts and dies. Flaming is most effective on young annual and perennial weeds in the seedling (4- to 5-leaf) stage, because at that point the fragile root system is killed along with the top growth. Grasses are difficult to kill by flaming because their growing tips are covered by a protective sheath.

Keep the torch about 6 inches above the vegetation and pass it slowly over the plants. Hold the flamer over each plant briefly so the plant is heated but not actually burned. The leaves may lose their usual green color, but there may not be any evidence of wilting, let alone plant death, for several to many hours. Leaves that have been heated sufficiently to burst cell walls will feel very soft to the touch and may turn a purplish color.

### Soil Solarization

This technique uses a covering of clear plastic to raise soil temperatures high enough to destroy weeds and their seeds. For solarization to be effective, daytime temperatures should average 85°F or more, so it should be done during the hottest and sunniest time of the year. Solarization can kill annual or perennial weeds as well as soil pathogens and nematodes. Even tough bermudagrass can be killed with this method. Solarization can also be used to destroy weed seeds and other soil pests in rototilled beds scheduled for new plantings.

To solarize a section of soil, do the following:

- Mow any existing vegetation to the ground.
- Cultivate to incorporate the vegetation into the soil.
- Provide a smooth surface by raking the soil so it is level.
- Encourage weed seeds to germinate by irrigating the soil 1 to 2 weeks before covering it.
- Irrigate again just before laying down the plastic.
- Use UV-stabilized plastic 2 to 4 mils thick.
- Anchor the tarp by burying its edges in a small soil trench around the area to be solarized.

- In the Southwest, wait 3 to 4 weeks before removing the plastic, and 6 to 9 weeks anywhere else.

### Chemical Controls

When non-chemical weed management methods are not sufficient to solve weed problems, herbicides are available for integration into the program. There are many herbicides on the market. For information on the efficacy and hazards of various herbicides and on how to select an appropriate product for your situation, consult Appendix G for a list of resources. When selecting herbicides, keep in mind the criteria described for treatments in Chapter 4. An example of using these criteria is provided in Box 18-A.

Whenever possible, apply herbicides as spot-treatments to the target weeds. For example, a tool called a “rope wick applicator” can be used to wipe a small amount of herbicide on a single plant or patch of weeds. This reduces human exposure and helps to protect non-target

#### Box 18-A

##### Selective Use of Low Toxicity Herbicides.

Tim Rhay, IPM specialist with the Eugene, Oregon Public Works Department, manages the city’s parks and sports fields within an IPM framework. His approach has been adopted by a number of local schools as well. When herbicides are needed, he selects materials that have relatively low toxicity and are compatible with spot-treatment. In discussing his infield/bare-soil weed management program (see also Physical Controls), he writes,

“The integrated methodology developed in Eugene...will both provide quality infield surfaces and reduce the resource requirement for doing so. In particular, the need for herbicide application will be dramatically reduced. Some spot treatment may be necessary to deal with noxious perennial plants that do not respond to cultivation. In some cases, a comprehensive treatment may be needed to gain initial control of an area. In some climate zones, treatment may be needed only at the infield/outfield interface, to prevent opportunistic vegetation from creeping into the bare soil area. When such treatment is required, consider low-toxicity granular preemergence materials which can be soil-incorporated during the dormant season, after the field is taken out of play...For postemergence work, newly available fatty acid-based herbicides [i.e., herbicidal soaps] may be useful for some types of vegetation. Others may require the use of foliar-applied, translocated materials such as glyphosate. Consult local regulatory and reference sources before choosing herbicide materials.” (Rhay 1994)



---

vegetation and beneficial soil organisms that can be damaged or killed by herbicide residues. Wick applicators are available as hand-held versions or as attachments to small tractors and riding mowers.

When applying herbicides, use a colorant to mark the treated area. This will not only insure even coverage, but will help passersby see and avoid the treated area. Do not allow children to play or lie on the treated area—rope it off and post a sign.

Herbicides must be used in accordance with their EPA-approved label directions. Applicators must be certified to apply herbicides and should always wear protective gear during applications. All labels and Material Safety Data Sheets (MSDS) for the pesticide products authorized for use in the IPM program should be maintained on file. Never apply these materials where they might wash into the storm drains, sanitary sewer, creeks, ponds, or other water sources.

## **BIBLIOGRAPHY**

- Aldrich, R.J. 1984. *Weed-Crop Ecology: principles in weed management*. Breton Publishers, Belmont, CA. 465 pp.
- Bio-Integral Resource Center (BIRC). 1996. 1997 directory of least-toxic pest control products. *IPM Practitioner* 18(11/12):1-39.
- Harrington, H.D. and L.W. Durrell. 1957. *How to Identify Plants*. Swallow Press, Chicago, IL. 203 pp.
- Hesketh, K.S. and C.L. Elmore. 1982. *Vegetable plantings without weeds*. University of California, Division of Agricultural Sciences, Berkeley, CA, Leaflet 21153, 19 pp.
- Katan, J. 1981. Solar heating (solarization) of soil for control of soil-borne pests. *Annual Review of Phytopathology* 19:211-236.
- Muenscher, W.C. 1980. *Weeds*. Cornell University Press, Ithaca, NY. 586 pp.
- Olkowski, W., S. Daar, and H. Olkowski. 1991. *Common sense pest control: Least-toxic solutions for your home, garden, pets and community*. Taunton Press, Newtown, CT. 715 pp.
- Radosevich, S.R. and J.S. Holt. 1984. *Weed ecology*. John Wiley and Sons, New York, NY. 265 pp.
- Rhay, T. 1994. IN: Leslie, A.R. ed. *Handbook of Integrated Pest Management for Turf and Ornamentals*. Lewis Publishers, Boca Raton, FL. pp. 611-612.
- Subcommittee on Standardization of Common and Botanical Names of Weeds. 1989. *Composite List of Weeds*. Weed Science Society, Champaign, IL. 112 pp.



## CHAPTER 19

# IPM FOR YELLOWJACKETS AND HORNETS IN SCHOOLS

### INTRODUCTION

Yellowjackets and hornets are both beneficial and problematic. They are predators and scavengers, helping to control pests and recycle organic materials, but they can also sting humans and their pets. Yellowjackets persistently search out protein-rich and sugary foods and drinks, so care must be taken whenever food is served outside. Although often grouped together with bees, yellowjackets pose a more serious threat to people. Because they have only tiny barbs on their stingers, yellowjackets can insert them repeatedly into a victim whereas a bee can sting only once. Multiple stings from yellowjackets are common because they vigorously defend their nest when it is disturbed.

### IDENTIFICATION AND BIOLOGY

“Yellowjacket” and “hornet” are the common names given to wasps in the genera *Dolichovespula*, *Vespula*, and *Vespa*; for the sake of simplicity, we will use the term “yellowjacket” in the following discussion. Note that these common names are not reliable indicators of whether or not they are pests (see Table 19-1 for more specific information).

Yellowjackets are relatively short and stout compared with paper wasps and other wasps (see Table 19-2). Paper wasps are more slender and have long, dangling legs. All yellowjackets are either white and black or yellow and black, are rapid fliers, and are more aggressive than other types of wasps. Their nests can be in the ground, in wall voids, or hanging from eaves or tree branches, but the nests are always completely enclosed (except for a small entrance hole at the bottom) with a papery envelope.

The queen begins her nest by building a small comb of chewed wood. She lays eggs in the cells and, after the eggs hatch, tends them herself. When some of the larvae develop into adult workers, they expand the nest into tiers, built one on top of the other (Figure 19-1). In the late summer or early fall, males and new

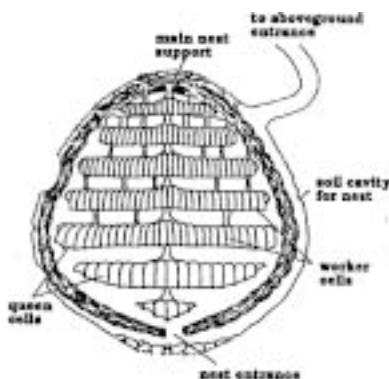

Figure 19-1. Yellowjacket Nest

queens are produced. After mating, the queens seek a sheltered place to spend the winter and, except in perennial colonies, all the worker wasps die. The nest is not reused and eventually disintegrates.



The Western Yellowjacket

Yellowjacket colonies seldom exceed 15,000 workers with a single queen, although they can become larger and can include multiple queens in perennial colonies. Early in the warm season, colonies are small and yellowjackets are usually not a problem. Later in the season when colonies are at their peak, these insects become pestiferous. They are attracted to garbage cans, dumpsters, lunch counters, and playgrounds, where they scavenge for protein and liquid sweets.

### STINGS

Insect stings are the leading cause of fatalities from venomous animals, and most of these stings are inflicted by yellowjackets. The people who die from yellowjacket or bee stings are people who experience large numbers of stings at once (hundreds in adults) or who suffer severe allergic reactions to the inflammatory substances in the insect venom. These allergic reactions include soreness and swelling not only at the site of the sting but also on other parts of the body that may be distant from the site. Other symptoms include fever, chills, hives, joint and muscle pain, and swelling of the lymph glands and small air passages. In severe cases, the individual may suffer a sudden drop in blood pressure and lose consciousness. Individuals who experience allergic reactions have become sensitized over time by previous stings, so this hypersensitivity is found more often in adults than in children.

Ordinary reactions to stings include localized pain, itching, redness, and swelling for hours to a day or two after the event.

See Box 19-A for first aid treatment for yellowjacket stings.

**Table 19-1. Major Yellowjacket and Hornet Species in North America<sup>a</sup>**

Species	Common Name	Distribution	Habits <sup>b</sup>
<i>Dolichovespula arenaria</i>	aerial yellowjacket	transcontinental	does not ordinarily scavenge for protein, but in late summer may be attracted to sweets
<i>D. maculata</i>	baldfaced hornet	transcontinental	predator and occasional scavenger; not as sensitive to nest disturbance; not a pest unless colony located close to human activity
<i>Vespa crabro germana</i>	European hornet	forested areas of eastern North America; native to Europe	predator; sometimes girdles branches and twigs of trees and shrubs; primarily a forest species, so has less contact with people and is therefore less of a stinging hazard
<i>Vespula acadica</i>	forest yellowjacket	forested areas of Canada, Great Lakes states, much of western U.S., & Alaska	strict predator; primarily a forest species so less contact with humans, but can be quite aggressive when nest is disturbed
<i>V. atropilosa</i>	prairie yellowjacket	prairies and open forest areas of much of western U.S. & Canada	strict predator; nests in yards, golf courses, pastures, etc., and can also nest in walls; usually not a problem unless nest is disturbed
<i>V. consobrina</i>	blackjacket	forested areas of Canada, northern U.S.	strict predator; primarily a forest species so less contact with humans, but can be aggressive when nest is disturbed
<i>V. germanica</i>	German yellowjacket	transcontinental; native to Europe	predator and scavenger; nests mainly in structures, but can nest in the ground or in trees; colonies can be perennial; exploits a variety of food sources, so is usually a pest; can be aggressive when nest is disturbed
<i>V. maculifrons</i>	eastern yellowjacket	eastern & central U.S. to the Mountain Region	predator and scavenger; nests in yards, golf courses, recreational areas, and buildings; is the primary pest yellowjacket where it occurs
<i>V. pensylvanica</i>	western yellowjacket	western North America and Hawaii	predator and scavenger; scavenges extensively for protein, especially later in the year; nests mainly in ground, but also in buildings; primary pest yellowjacket where it occurs; can be aggressive when nest is disturbed
<i>V. squamosa</i>	southern yellowjacket	eastern, southeastern U.S. to Central America	predator and scavenger; parasitic on <i>V. maculifrons</i> ; will scavenge for protein; nests mainly in the ground in disturbed areas, but also in buildings; perennial colonies possible in subtropical locations; can be aggressive when nest is disturbed
<i>V. vidua</i>	none	eastern U.S.	predator; nests mainly in the ground in disturbed areas but also forests, sometimes in buildings; not a stinging hazard unless nest is located where it can be disturbed by human activity
<i>V. vulgaris</i>	common yellowjacket	transcontinental, Hawaii; prevalent in heavily forested areas in the West	predator and notorious scavenger of nearly any protein or sugar source; nests mainly in the ground, but also in buildings; colonies can be very large

<sup>a</sup> From Akre et al., 1981.

<sup>b</sup> Those species that are scavengers are more likely to be pests around garbage cans and where food is eaten outside.

## NEST DISTURBANCE

Yellowjackets that are foraging for food will usually not sting unless physically threatened in some way, such as being squashed or caught in a tight place. But if they feel their nest is in danger, they will vigorously defend it. All wasps defend their colonies, but some yellowjackets are more sensitive to nest disturbance and more aggressive in their defense. Disturbing the nests of these species can result in multiple stings. This can occur when someone accidentally steps on an underground nest opening or disturbs a nest in a shrub or in a building. Sometimes merely coming near a nest, especially if it has been disturbed previously, can provoke an attack.

Underground nests can be disturbed by vibrations detected by the wasps. Thus, mowing lawns or athletic fields can be hazardous, and operators may need to wear protective clothing when mowing during the late summer season when colonies are large. Such clothing should include a bee suit with a protective bee veil or, at the very least, a veil and wrist and ankle cuffs taped or carefully tied to keep the insects out of sleeves and pant legs. A heavy sweatshirt can also be protective.

It can be very frightening to be the victim of multiple

wasp stings. The first response may be to run away, but since it is impossible to outrun the wasps, running will only make the situation worse by exciting the wasps more. The best strategy is to back slowly away from the colony until you are at least 6 to 8 feet away.

It is important to educate children about the beneficial role of these wasps (they feed on pest insects, particularly caterpillars) and to remind them repeatedly of ways to avoid stings. Since problems with yellowjackets are most common in late summer and fall, teachers can be provided with this information at the beginning of the fall term. See Box 19-A for tips on avoiding stings.

## DETECTION AND MONITORING

If there is a chronic problem with yellowjackets around outdoor lunch areas or school athletic fields, inspect the area methodically to locate the nests. Nests can be found in the ground, under eaves, and in wall voids of buildings. Ground nests are frequently (but not always) located under shrubs, logs, piles of rocks, and other protected sites. Entrance holes sometimes have bare earth around

**Table 19-2. Distinguishing Yellowjackets, Wasps, Bees, and Hornets**

	Appearance	Habits	Nests	Feeding Behavior
<b>Bees</b>	Hairy, stout bodies with thick waists; workers & reproductives are winged	Noisy flight; sting mainly while defending nest; foraging workers seldom sting	In hives, trees, or buildings	Collect pollen and nectar, feed pollen to young & share food with other adult bees
<b>Wasps</b>	Bodies vary; all winged	Colorful, rapid fliers; solitary & social varieties	Aerial or ground nests; can be in structures	Scavengers and/or predators
Solitary wasps	Thin- or thick waisted	Visit flowers & other vegetation; relatively docile	In mud, or in holes in ground	Predators; provision nests with prey for young to feed on
Yellow jackets	Stout, colorful	Rapid fliers; aggressive individuals capable of inflicting multiple stings; social in large colonies which they defend vigorously	Multi-layered, papery nests mostly in ground, although some aerial or in structures; nests have an outer papery covering called an "envelope"	Mostly beneficial predators, but scavenger species become pestiferous
Paper (umbrella) wasps	Long bodies with thin waists, long dangling legs	Social; search vegetation for prey; visit flowers for nectar; not particularly aggressive	Single layered, papery nests without an envelope; attached to fences, eaves, boards, branches; shaped like an umbrella	Beneficial predators; feed prey to developing young in nest

**Table 19-2. Distinguishing Yellowjackets, Wasps, Bees, and Hornets**

	Appearance	Habits	Nests	Feeding Behavior
<b>Bees</b>	Hairy, stout bodies with thick waists; workers & reproductives are winged	Noisy flight; sting mainly while defending nest; foraging workers seldom sting	In hives, trees, or buildings	Collect pollen and nectar, feed pollen to young & share food with other adult bees
<b>Wasps</b>	Bodies vary; all winged	Colorful, rapid fliers; solitary & social varieties	Aerial or ground nests; can also be in structures	Scavengers and/or predators
Solitary wasps	Thin- or thick-waisted	Visit flowers & other vegetation; relatively docile	In mud, or in holes in ground	Predators; provision nests with prey for young to feed on
Yellow-jackets	Stout, colorful	Rapid fliers; aggressive; individuals capable of inflicting multiple stings; social in large colonies which they defend vigorously	Multi-layered, papery nests mostly in ground, although some aerial or in structures; nests have an outer papery covering called an "envelope"	Mostly beneficial predators, but scavenger species become pestiferous
Paper (umbrella) wasps	Long bodies with thin waists, long dangling legs	Social; search vegetation for prey; visit flowers for nectar; not particularly aggressive	Single layered, papery nests without an envelope; attached to fences, eaves, boards, branches; shaped like an umbrella	Beneficial predators; feed prey to developing young in nest

them. Nest openings in the ground or in buildings can be recognized by observing the wasps entering and leaving.

## MANAGEMENT OPTIONS

The objective of a yellowjacket management program should be to reduce human encounters with the wasps, but not to eliminate them from the entire area since they are beneficial predators of caterpillars. The two most productive and least environmentally destructive ways to do this are to modify the habitat to reduce yellowjackets' access to food in the vicinity of human activities, and to use physical controls such as

trapping and nest removal. Area-wide poison-baiting should be used only as a last resort when other methods have failed and stings are frequent.

### Physical Controls

#### Habitat Modification

Garbage cans on school grounds should have removable domed tops with vertical spring-loaded swinging doors. The cans should be emptied frequently enough to prevent the contents from impeding the closure of the lid. The lids and cans should be periodically cleaned of food wastes. Disposable liners can be used and replaced when

### Box 19-A.

#### Avoiding and Treating Stings

Children should be taught to stay calm when confronted by a foraging yellowjacket. Impress upon them that sharp, jerky motions will frighten wasps and make them more likely to sting. Stillness, or slow, gentle movements, which can be described to children as "moving like the swaying branches of a tree," will greatly decrease the possibility of being stung. Slowly and carefully brushing off a yellow-jacket that has landed on someone, or waiting until it flies off is better than hitting or constraining it since aroused yellowjackets will sting. It is important to avoid smashing yellowjackets because when crushed, they give off a scent that can cause other yellowjackets to attack.

If soft drinks or fruit juices are being consumed on school grounds where there are many yellowjackets, warn the children to look into the cup or can before each sip, because someone can accidentally drink in a wasp and get stung in the mouth or throat. Tell them not to panic if they find a wasp taking a drink. They should wait patiently until the wasp leaves by itself, then place a napkin or similar barrier over the cup between sips. Children can also use a straw for drinking or place the drink in a paper bag and poke a hole through it for the straw. Alternatively, eating and drinking outside can be prohibited during yellowjacket season.

Gardeners or custodians should wear protective clothing when mowing grass where underground nests are suspected.

#### First Aid for Stings

- If the sting is to the throat or mouth, medical attention must be sought immediately, because swelling in these areas can cause suffocation. Dial 911 immediately and

give the victim an ice cube to suck.

#### For hypersensitive individuals

- Anyone who is hypersensitive or is showing respiratory reactions, dizziness, or color changes should be treated by the school nurse or taken to a doctor immediately. The nurse should have an emergency kit containing pre-loaded syringes of epinephrine for use with hypersensitive individuals. An antihistamine such as diphenhydramine (e.g., Benadryl) can stop or slow symptoms, but it must be given immediately.
- Keep the affected part down, below the level of the victim's heart.

#### For all others

- Wash the area around the sting with soap and water and apply an antiseptic. Washing can help remove the protein venom from the wound which will help reduce the pain and swelling from the sting.
- As soon as possible, treat the sting either with ice contained in a cloth or plastic bag, commercially available products for easing the pain of wasp or bee stings, or a paste of meat tenderizer mixed with water. Ice will help reduce the swelling, and the commercial products will relieve pain as well as swelling. Meat tenderizer works by breaking down the venom, thus reducing swelling and pain.
- Antihistamines given every few hours, according to label directions, can also prevent pain and swelling.
- Have the victim rest, and do not administer sedatives such as alcohol.

soiled or damaged.

When these practices are not followed, school garbage cans become a food source for all the yellowjackets in the area. With a large number of wasps around the cans, students become afraid to get close enough to place garbage all the way inside, and spilled food attracts more wasps.

Dumpsters should be cleaned frequently by washing them with a strong stream of water. If the dumpster service company has a cleaning clause in their contract, make sure it is enforced.

To limit yellowjacket infestations inside the school buildings, repair windows and screens and caulk holes in siding. Building inspections for yellowjackets can be done at the same time as inspections for other pests such as rats, mice, termites, etc.

### Trapping

Trapping with a sturdy trap and an attractive bait can significantly reduce yellowjacket numbers if a sufficient number of traps are used. There are a variety of traps on the market. In general, cone-type traps are more useful for long-term (many weeks) trapping because it takes longer for the yellowjackets to find their way out of the trap. In some schools, unbaited yellow sticky traps (like those used to catch whiteflies) affixed to fences near underground nests have provided sufficient control to protect children from stings.

When traps are full they can either be placed in a freezer for a day to kill the wasps or enclosed in a heavy-duty plastic garbage bag and placed in the direct sun for several hours. A third way of killing the wasps is by submerging the traps in a bucket of soapy water until the wasps drown.

A homemade, cone-type fly trap (Figure 19-2) can be used to catch yellowjackets simply by using the captured flies inside the trap as bait (see Chapter 9 for a discussion on how to catch flies). The yellowjackets enter the trap to get the flies and become trapped themselves (see Box 19-B for tips on this kind of trapping). You can also try using baits such as dog food, ham, fish, and other meat scraps, or, toward the end of the warm weather, sugar syrups, fermenting fruit, and jelly.

Take care to place traps out of the children's reach as much as possible; however, the traps should be placed near the nest if it can be found, and/or near the area where the yellowjackets are troublesome. Teachers can be

### Box 19-B.

#### Tips on Trapping Yellowjackets in a Homemade Cone-Type Fly Trap

Yellowjackets can be caught in a cone-type fly trap (Chapter 9, IPM for Flies in Schools, includes bait recipes and plans for making such a trap) using only the trapped flies as bait. The following tips will help improve yellowjacket trapping:

- Use this trapping method where students cannot gain access to the traps or at a time when students are not in school.
- Mix the fly bait according to the instructions in Chapter 9 of this manual.
- Set up the fly trap with the fly bait in the area where the yellowjackets are a nuisance.
- If after a day or two in one spot the trap is still attracting only flies, move it to a new spot around the perimeter of the nuisance area.
- If your trap stops catching yellow-jackets at some point, but is still catching flies, try switching to a sweet bait such as fruit punch, jam, or grenadine.

NOTE: To avoid being stung, you should replenish the fly bait or move the trap in the cool parts of the day—early morning or late evening. To kill everything in the trap before emptying, put the trap into a large plastic garbage bag and seal the bag. Place the bag in direct sunlight for several hours or in a freezer overnight. You can also loosely tie the bag to the exhaust pipe of a gasoline engine and run the engine for a minute or two.

Top is also made of screening. Top should be hinged (to empty the trap) and closed with a hook and eye. Weather-stripping or a strip of foam or cloth glued to all 4 sides of the underside of the lid will prevent flies from squeezing out.

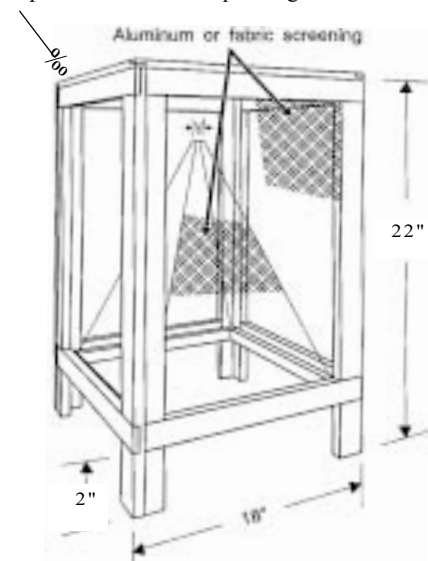

Figure 19-2. Cone Trap. Bait pan is placed beneath bottom of the cone. Make sure the top edge of the bait pan is above the bottom edge of the trap.



instructed to make a short presentation on the purpose of the traps to satisfy the curiosity that students will undoubtedly have. Show students the traps, explain how they work, and try to impress upon them the importance of the traps in maintaining the safety of the playground.

The traps should be out only during the period that yellowjackets are a problem, usually late summer and early fall. When the traps are taken down for the year, they should be cleaned with soap and water and stored.

### **Nest Removal**

A nest can be destroyed through physical removal (vacuuming) or by using a pesticide (see Chemical Controls). Either way, care is essential because any disturbance around a nest can cause multiple stings. It is best to have a professional pest control operator or other person experienced with these techniques remove the nest, and it should be done at night when the children are out of school and the yellowjackets are in their nests. When illumination is needed, use a flashlight covered with red acetate film so it will not attract wasps. Adequate protective clothing (see Box 19-C) and proper procedure can minimize problems and stings. People who are sensitive to wasp stings should not attempt control procedures.

### **Vacuuming**

We do not recommend vacuuming out entire nests unless it is done by a professional experienced in handling stinging insects.

Vacuuming can be particularly effective where nests occur in wall voids, in emergencies where nests have already been disturbed, and in environmentally sensitive areas where nests should not be treated with insecticides. Use a lightweight, powerful vacuum with a removable bag. Before the bag is completely full of wasps, vacuum up 2 tablespoons of cornstarch to incapacitate the insects. Leaving the motor running, detach the hose from the canister to reveal the opening in the vacuum bag. Stuff this opening with newspaper, paper towels, or a rag. With the motor still running, open the canister and tape over the bag opening with duct tape. With the motor off, take out the bag and place it inside a cardboard box. Seal the box and place it in a freezer at least overnight.

Before vacuuming an underground nest, check for secondary entrance holes (these can be identified by the wasps flying in and out) in a 40 to 50 foot area around the main opening. If these secondary entrances are not covered with a good quantity of soil before vacuuming begins, they will provide outlets for angry

### **Box 19-C.**

#### **Protective Clothing for Nest Destruction**

It is important to wear protective clothing when removing wasp nests. Complete body coverage is essential because yellowjackets and other wasps can find even the smallest exposed area. Use clothing made for beekeepers. This includes:

1. A bee veil or hood that either contains its own hat or can be fitted over a light-weight pith helmet or other brimmed hat that holds the veil away from the head. A metal-screen face plate that extends around the head is a desirable feature. Check the veil carefully for tears before each use.
2. A bee suit or loose-fitting, heavy-fabric coverall with long sleeves. This is worn over regular pants and a long-sleeved shirt to provide extra protection from stings.
3. Sturdy high-topped boots with pant legs secured over the boots with duct tape to prevent wasps from getting into trousers.
4. Gloves with extra-long arm coverings so sleeves can be taped over them to protect the wrists.

wasps.

Vacuuming the nest is a job for two people, both covered with protective clothing. While one person operates the vacuum, the other excavates the nest with a trowel. The vacuum operator doesn't actually insert the hose into the nest; instead, the wand is positioned 3 or 4 inches away from the nest opening to suck in yellowjackets as they fly in and out. When no more wasps are seen entering or leaving, the underground nest structure should be dug out, placed in a plastic garbage bag, and set in the sun for several hours.

In some cities there are companies that will perform this service for free so they can collect the wasps to sell to pharmaceutical companies for their venom. If the school is interested in this, take time to find a reputable company.

### **Chemical Controls**

If non-chemical methods alone prove insufficient to solve the problem, then integrating a pesticide into your management program may be warranted. For information on the hazards of various pesticides and on how to select an appropriate pesticide for your situation,

consult Appendix G for a list of resources.

Pesticides must be used in accordance with their EPA-approved label directions. Applicators must be certified to apply pesticides and should always wear protective gear during applications. All labels and Material Safety Data Sheets (MSDS) for the pesticide products authorized for use in the IPM program should be maintained on file. Do not apply these materials when buildings are occupied, and never apply them where they might wash into the sanitary sewer or into outside storm drains.

When an insecticide is considered necessary for the control of yellowjackets, the best approach is to confine it to the nest itself. Anyone applying insecticides should use special clothing that protects against the chemical as well as against wasps. This should include a respirator, goggles, coveralls, and rubber gloves, as well as a bee suit with a veil (see also Box

19-C). Apply insecticides in the evening or very early morning when children are out of the school, the wasps are in their nests, and cool temperatures reduce the insects' ability to move around.

Of the main insecticides registered for use against yellowjackets, the following are most appropriate for use in schools.

#### **Pyrethrin Aerosol**

Pyrethrin can be used to quickly knock down guard wasps at the nest entrance and to kill yellowjackets in an aerial nest once the nest has been cut down and is inside a plastic bag. Only very small amounts of this material are necessary to kill the wasps and there is no need to use more (consult Box 19-D for the specific procedures for poisoning nests).

#### **Silica Aerogel and Pyrethrin**

Silica aerogel combined with pyrethrin is an effective insecticidal dust that can be used to destroy an under-

### **Box 19-D. How to Destroy Nests Using Pesticides**

Application of pesticides to yellowjacket nests should be made in the evening or early in the morning, and the pest control operator should always wear protective clothing (see Box 19-C).

#### **Aerial Nests**

1. If necessary, use a pole-pruner to trim branches away from the nest. Be extremely careful if you do this.
2. Using a ladder, climb near enough to the nest to squirt a half-second blast (no more is necessary) of aerosol pyrethrin (0.3% or 0.5%) around the nest entrance hole to kill the guard wasps.
3. Cover the nest with a large, heavy-duty, black plastic garbage bag and cut off the branch from which the nest is hanging or cut the nest off the branch.
4. On a sunny day, twist the top of the plastic bag, fold the twist over and secure with a twist tie. Leave the bag in the sun for 2 or 3 hours to kill the wasps.

On a cool or cloudy day, you may need to use insecticide to kill the wasps. Gather the top of the plastic bag together, insert the nozzle of the aerosol pyrethrin (0.3% or 0.5%), and squirt in another half-second blast. Do not over-treat. This small amount of pyrethrin is enough to kill the yellowjackets.

5. Dispose of the bag in the garbage.

#### **Ground Nests**

1. Check the area 40 to 50 feet around the nest before treating. If another entrance is found, use a half-

second blast of aerosol pyrethrin (0.3% or 0.5%) to kill the guard wasps, stuff the hole with newspaper or paper towels, and cover it with soil.

2. Use a half-second blast of the aerosol pyrethrin to kill the guards at the main entrance.
3. Using a 4-way tip on the aerosol, spray inside the entrance hole for 5-10 seconds. Do not over-treat. Stuff the hole with newspaper or paper towels but do not cover it with soil.
4. After waiting a few minutes, remove the paper from the entrance hole. Use a bulb duster to apply silica aerogel plus pyrethrin to the interior of the cavity and the nest. A few pumps should apply sufficient material. If the nest is located some distance back from the ground opening, attach a length of PVC tubing to the bulb duster to extend its reach.
5. Stuff a piece of coarse steel wool or copper mesh that has been treated with a light dusting of silica aerogel plus pyrethrin into the entrance hole. Any wasps trying to get in or out will chew on the steel wool and be killed by the insecticide.

#### **Nests in Wall Voids**

Wasp colonies in wall voids can be eliminated using the same procedure detailed above for ground nests.

After removing the colony, make any necessary structural changes to prevent wasps from reinfesting.

---

ground nest or a nest in a wall void after the guard wasps have been killed (see Box 19-D). Silica aerogel is made essentially from sand and works by absorbing the outer waxy coating on insect bodies. Once this coating is gone, the insects cannot retain water and die of dehydration.

### **Products with Components That “Freeze” Wasps**

In emergency situations when nests must be destroyed in the daytime, it is helpful to carry one of these products as a safety precaution. These aerosol products are designed to project their spray a distance of 10 to 20 feet and contain highly evaporative substances that “freeze” or stun the yellowjackets.

### **Do Not Use Gasoline**

Many people pour gasoline into underground nest holes. This is a fire hazard, contaminates the soil, and prevents growth of vegetation for some time. It is a very dangerous procedure.

### **Avoid Area-Wide Poisoning**

Mass poisoning is seldom, if ever, necessary, and is expensive due to the labor involved in the frequent mixing and replacement of bait. The effectiveness of bait mixtures is also questionable, since the baits face considerable competition from other food sources attractive to

scavenging yellowjackets.

## **BIBLIOGRAPHY**

- Akre, R.D. and A.L. Antonelli. 1991. Yellowjackets and paper wasps. Washington State Univ., Pullman, WA, Cooperative Extension Bulletin No. EB0643, 6 pp.
- Akre, R.D., A. Greene, J.F. MacDonald, P.J. Landolt, and H.G. Davis. 1981. Yellowjackets of America North of Mexico. U.S. Department of Agriculture, Washington, D.C., USDA Agricultural Handbook 552, 102 pp.
- Bio-Integral Resource Center (BIRC). 1996. 1997 directory of least-toxic pest control products. *IPM Practitioner* 18(11/12):1-39.
- Krombein, K.V., P.D. Hurd, Jr., D.R. Smith, and B.D. Burks. 1979. Catalog of Hymenoptera of America North of Mexico, Volumes I, II, and III. Smithsonian Institution Press, Washington, D.C. 1198, 2209, and 2735 pp., respectively.
- Olkowski, W., S. Daar, and H. Olkowski. 1991. Common-Sense Pest Control: Least-toxic solutions for your home, garden, pets and community. Taunton Press, Newtown, CT. 715 pp.
- Turkington, C. 1994. Poisons and Antidotes. Facts on File, New York, NY. 372 pp.

---

# APPENDIX A

## IPM-RELATED CURRICULA AND RESOURCES FOR THE CLASSROOM

### BugPlay

For grades K through 3. Hands-on experiences with harmless insects help students develop an appreciation for these amazing creatures. Lessons, with accompanying music cassette, include the use of poems, songs, and drawings. Available from:

Addison Wesley Publishing Co.  
(800) 552-2259

### Learning About Pesticides at School: Project Ideas for High School or Middle School Classrooms or Student Environmental Clubs

September, 1995 22 pp. plus 8 page glossary

Teaching/learning activities designed for middle school and high school level students. Includes a variety of activities which can be combined into one comprehensive school pesticide use reduction project. This is an ideal project for interdisciplinary classes or environmental clubs. The project also involves activities appropriate in traditional health, chemistry, biology, ecology, math, speech, and social studies classrooms. Better yet, it involves students in a “real-world” project that will make a difference in their own lives. Available from:

Northwest Coalition for Alternatives to Pesticides (NCAP)  
P.O. Box 1393  
Eugene, OR 97440  
(541) 344-5044

### Legacy of a Pest

Science, technology, and social curriculum guide for understanding and dealing with pest problems. The over 50 teacher-tested activities deal with the gypsy moth problem, its life cycle, IPM control strategies, chemical control strategies, and more. 243 pp. Available from:

Legacy of a Pest  
607 E. Peabody Dr.  
Champaign, IL 61820  
(217) 333-6880

### Living With Insects in the Big City: Urban Insect Ecology and Safe Pest Management

A curriculum for grades K-3. Contains hands-on activities, teaches science framework concepts and applies biological concepts to our urban world. Includes graphic aids. Available from:

Citizens for a Better Environment (CBE)  
500 Howard St., Ste. 506  
San Francisco, CA 94105  
(415) 243-8373

---

### Teaching Ideas: Pesticide Awareness and the Concept of Integrated Pest Management

Curriculum is suitable for use in middle, junior, or senior high school biology, ecology, or social studies courses. Included is “How to Map Pesticide Use in your School (and Community),” and four lesson plans on pesticides and Integrated Pest Management concepts. Available from:

Northwest Coalition for Alternatives to Pesticides (NCAP)  
P.O. Box 1393  
Eugene, OR 97440  
(541) 344-5044

### The Growing Classroom

For grades 2 through 6. Students use indoor and outdoor gardens for the study of science and nutrition through experimentation, investigation, and data collection and analysis. Available from:

Addison Wesley Publishing Co.  
(800) 552-2259

### The Young Entomologists’ Society (Y.E.S.)

An international society of young and amateur insect enthusiasts. Operates on a membership basis, publishes several newsletters, sells books, educational toys, and clothing. Encourages active involvement of its young members and communication with each other, primarily through the mail. A catalog of their publications is available.

Y.E.S. Inc.  
1915 Peggy Place  
Lansing, MI 48910-2553  
(517) 887-0499

### Integrated Pest Management and Biological Control in Agriculture

Bring IPM ideas into the classroom with BIRC’s new IPM curriculum, a thorough introduction to the concept of integrated pest management with case studies, class exercises, resources and more. Four units for grades 9-12: What is IPM?; Aphids and their Predators; 15 Million Bushels of Oats—Process or Perish?; A Pest Management Interview. 200pp. \$23.00 + \$3.50 postage/handling.

B.I.R.C.  
P.O. Box 7414  
Berkeley, CA 94707  
(510) 524-2567

---

# APPENDIX B

## HOW TO DEVELOP AN IPM PROGRAM

### THE TWO PHASES OF IPM PROGRAM DEVELOPMENT

IPM program development generally occurs in two major phases: the start-up phase and the operational phase. The start-up phase involves educating key decision-makers about the need for the program, adopting an IPM policy and addressing administrative issues, and identifying the roles and responsibilities of the various members of the school community in operating a successful IPM program. The operational phase involves designing and implementing IPM programs for specific pests; training pest management, custodial, grounds maintenance, and nursing staff in IPM methods; and institutionalizing the IPM program.

### START-UP PHASE

#### Educating key decision-makers

The stimulus for development of successful IPM programs in schools has come primarily from concerned parents. The key to success is educating the school board, superintendent, business operations manager, principals, PTA officers, and other decision-makers about potential problems with pesticide-based programs and presenting them with viable alternatives offered by the IPM approach.

Two publications are useful in this early phase: *Getting Pesticides out of Schools*, published by Northwest Coalition for Alternatives to Pesticides in Eugene, OR, and the booklet, *Pesticides in our Communities: Choices for Change*, a community action guide published by Concern, Inc., in Washington, D.C. (see the bibliography at the end of this chapter for details on where to obtain these publications). Box A summarizes twelve steps for pesticide use reduction in schools.

#### Adopting an IPM policy

Adoption of an IPM policy by the school board is key to starting an IPM program. A sample IPM policy is provided in Appendix C.

#### Identifying pest management roles and responsibilities

It is critical that representatives from all segments of the school community be involved in setting up the IPM program from the beginning in order to foster their “buy-

in” to the process and the program. This includes school board members, administrators and staff, teachers, students, parents, custodians, food service workers, ground maintenance personnel, school nurses, and pest control professionals. When the respective roles of all the people involved directly or indirectly with pests in the school system are identified and agreed upon, and when these people communicate well with each other, effective and less expensive protection of the site and the people can be achieved with reduced risk from pesticides. A discussion of roles and responsibilities is provided in Box B.

### OPERATIONAL PHASE

The operational phase involves designing IPM programs for specific sites and pests, delivering IPM services, and evaluating program costs. Fully-developed, multi-tactic IPM programs are generally implemented in three stages, although components of each stage often overlap.

Stage 1 introduces monitoring and pest action thresholds to replace routine pesticide applications, and develops preliminary pest management objectives. Schools that have relied primarily on routine pesticide applications usually begin with a Stage 1 IPM program, and work up to a more complex stage as they develop experience and confidence in the IPM approach. Box C outlines tips for getting programs started.

Stage 2 formalizes pest management plans and maximizes pest-proofing, education, and non-chemical pest suppression. Stage 3 institutionalizes the IPM program.

### STAGE 1 IPM

Stage 1 IPM focuses primarily on moving away from routine use of pesticides by instituting a pest monitoring program to collect data and establish pest treatment (action) thresholds based on pest population levels (see Chapters 2 and 3). A pilot program is initiated at one school site, so new skills can be gained and techniques fine-tuned before the program is expanded throughout the system.

Pesticides may remain the primary control agents used during this stage, but applications are made only when pest numbers reach action levels. Spot-treatments rather than area-wide applications are stressed, non-volatile baits and dusts are substituted for vaporizing

## Box A

### STEPS TO SCHOOL PESTICIDE USE REDUCTION\*

1. DO YOUR HOMEWORK
  - Find allies, network.
  - Develop a basic plan, establish goals (but remain flexible).
  - Compile information on hazardous pesticides and their alternatives.
  - Be prepared to answer statements countering your arguments.
  - Gather information on the organization of your school and school district (who's responsible for what).
  - Maintain records.
2. MEET WITH SCHOOL OFFICIALS
  - Determine the level of interest and cooperation for your pesticide reduction plan.
  - Schedule a meeting with those school representatives who need to be involved in a plan to reduce school pesticide use (safety officers, grounds keepers, school pest management personnel, etc.).
  - Bring allies and an agenda to your meeting.
  - Ask questions. For example, which pests are present? What chemicals are being used to control them? When and how often are pesticide applications done and by whom? Who makes the decisions about application. Are alternatives considered? What kind of records are kept? Is the school nurse trained to recognize pesticide poisoning?
  - Be friendly but insistent.
3. EVALUATE AND IDENTIFY STRATEGIES
  - Determine the level of cooperation you're likely to receive and develop a plan accordingly.
4. MEET WITH OR WRITE THE SUPERINTENDENT
  - Make him/her aware of your concerns.
5. DOCUMENT SCHOOL PESTICIDE USE
  - Include in your report
    - an introduction about the hazards of pesticide use in schools
    - the types, uses, and hazards of chemicals used in your district
    - basic recommendations for alternatives (hire an entomologist to do an on-site assessment!)
6. DEVELOP A SCHOOL IPM POLICY
  - Get your school board to develop a system-wide pesticide reduction policy.
  - Watch for soft language—policy wording that is open to interpretation can be used to justify spraying.
7. CONSIDER COSTS
  - Compare the costs of IPM and conventional pest control methods.
  - Remember to point out long-term budgetary issues.
8. EDUCATE AND ORGANIZE
  - Prepare a presentation for parent groups, student groups, school personnel, and other appropriate community groups.
  - Have a handout ready.
9. WORK WITH THE MEDIA
  - Define your message.
  - Get the word out in the community.
10. ADVOCATE FOR THE IPM POLICY
  - Lobby school board members. Gather petitions in support of the IPM policy.
  - Hold public meetings and have teacher's reps. and experts on health, the environment, and children ready to speak.
  - Include the media.
  - Be prepared to handle objections.
11. SELECT A COMMITTEE
  - Organize a pesticide use reduction committee to oversee developments and implementation.
12. CELEBRATE AND NETWORK

\*Adapted from Taylor 1991

sprays, and less-toxic soaps, oils, and microbial materials replace more toxic compounds.

At the same time, a planning process is established to set pest management objectives, identify the root causes of pest problems in the school system, and assess methods to address these causes with primarily non-chemical solutions.

## STAGE 2 IPM

Stage 2 IPM involves a concerted effort to incorporate physical, mechanical, biological, and educational strategies and tactics into the pest management program, and to further reduce pesticide use.

Most pests found in school buildings can be attributed to faulty building design, lack of structural repairs, and poor food handling and waste management practices. To achieve permanent solutions to pest problems, pest management staff must devote time to educating building maintenance and custodial staff, food

handlers, and teachers and students about their role in attracting or sustaining pests, and enlisting their participation in solving the problems.

A similar process is needed to solve outdoor pest problems. For example, cooperation from physical education and coaching staff is needed to reduce stress on athletic turf that leads to weed problems. Landscape maintenance staff need encouragement to locate pest-resistant plant materi-

als, increase diversity in the plantings to attract natural enemies of pests, and experiment with non-chemical pest control methods. Assistance from playground supervisors is needed to insure that food debris and other wastes are placed inside waste receptacles where rats, yellowjackets, etc. cannot gain access to the wastes.

The primary activities during this stage include developing site-specific pest management plans and educating all

## Box B

### Identifying Pest Management Roles\*

In successful school IPM programs, students, staff, parents, pest managers, and decision-makers all have important roles. These functions and responsibilities are identified below.

#### Students and Staff—The Occupants

Students and staff have a major role to play in keeping the school clean. Sanitation should not be viewed as only the custodian's job. If students and staff are shown the connection between food and garbage and pests such as cockroaches, ants, flies, and rodents, they are more likely to take sanitation measures seriously and comply with them. Rules for sanitation should be clear and succinct and they should be strictly enforced.

#### The Pest Manager

The pest manager is the person who observes and evaluates (or directs others to do so) the site and decides what needs to be done to achieve the pest management objectives. The pest manager designs an IPM program that takes into account potential liability, applicator and occupant safety, costs, effectiveness, environmental impacts, time required, and customer or occupant satisfaction.

The pest manager draws on knowledge gained through experience and prior training and uses information from the site and the pest and its biology. Since the pest manager usually has the responsibility of keeping both the occupants and the decision-makers (management) informed, he or she has the greatest need for information about the site, pest, and appropriate pest management methods.

The IPM program for the site must achieve the goals within the limitations posed by safety, time, money, and materials available. Pest managers

monitor the site and the pest populations to determine if actions taken are successful, and must keep accurate records of the amount and location of all treatments, including pesticides, dates of each treatment, and the level of effectiveness of the treatment.

#### Decision-Makers

Generally, persons who authorize the IPM program and control the money for pest management are people involved in the school administration, such as a Superintendent or Assistant Superintendent of Schools. However, a person indirectly involved with the site may become a pest management decision-maker, e.g., the Health Department Inspector. On other occasions, the purchasing agent or contracting officer for a school system or district may be a major decision-maker for a school site.

At this level of pest management decision-making, concerns about costs, liability, time expended, method effectiveness, safety, and customer or occupant satisfaction are foremost. Decision-makers also determine if the pest manager is performing at an acceptable level and if the pest management objectives are being met. This can be done by monitoring complaints from occupants, periodic evaluation and review of pest management strategy and effectiveness, observation of the site environment, inspections by external sources, or by a combination of these and other methods. Decision-makers must also provide the necessary level of financial commitment for any IPM program to succeed. With adoption of an IPM policy and use of model IPM contract language, there is less chance of error in communication between the different parties involved.

\*Adapted from U.S. EPA 1993



---

participants about their roles and responsibilities in helping to implement the plans.

### **Developing site-specific pest management plans**

Written plans help move school pest control from a reactive system to a prevention-oriented system. Annual plans enable pest managers to prioritize use of resources, justify planned expenditures, provide accountability to IPM policies, and coordinate with other components of the school system.

These plans emphasize repairing buildings, changing waste management procedures to deny food, water, and shelter to indoor pests, and modifying plant materials and landscape maintenance practices to relieve plant stress and improve plant health.

Costs of these repairs and changes may fall within on-going operation expenses in existing budgets, or may require a one-time expenditure. In the long-term, however, these activities will reduce overall pest control costs as well as other maintenance and operating budget expenses.

### **Educating participants**

Food service and custodial staff, clerical and administrative staff, teaching staff, and students must be educated about their role in reducing pest presence in order to enlist their cooperation.

Everyone must understand the basic concepts of IPM, who to contact with questions or problems, and their role as participants in the program. Specific instructions should be provided on what to do and what not to do.

Teachers and staff should be discouraged from bringing pesticides to school and applying them on school sites. Instead they should be provided with clear instructions on how and to whom to report a pest problem. One option is to provide teachers, etc., with “pest alert” cards on which they can write the date, location, and pest problem. The card can be returned to the teacher with a notation of what was (or will be) done about the problem and what, if any, assistance is requested of the teacher and students (e.g., better sanitation in the classroom, etc.).

If information on IPM can be woven into the current curriculum, students and teachers will better understand their roles and responsibilities in the program, but more than this, students will carry these concepts into their adult lives. Education is the only way to make a significant, long-term impact on pesticide use in this

country, and what better place to start than in schools? The following ideas are just a few of the ways that this information can be included in the school curriculum:

- involve science classes in identifying pests and in researching IPM strategies
- involve art classes and English classes in developing simple fact sheets and other educational materials on various school pests (use information from the pest by pest chapters in this manual)
- involve vocational classes in making site plans of the school to use for monitoring, in making site inspections for structural defects that may exacerbate pest problems, and in suggesting structural modifications to eliminate the problems
- involve journalism classes in reporting on the new IPM program
- use some of the innovative curricula available that emphasize IPM (see Appendix A for a list)

## **STAGE 3 IPM**

Stage 3 IPM involves institutionalizing the IPM program. This includes developing on-going incentives and reward systems for achieving IPM objectives, establishing an IPM library of educational materials and staff training programs, and writing operations manuals that describe IPM policies and procedures to be followed by pest management personnel.

### **Develop incentives and rewards**

Involve staff in establishing benchmark objectives (e.g., 20% pesticide reduction the first year, testing of boric acid in place of organophosphate roach sprays, raising of mowing height on turf to shade out weeds, etc.). Reward them for innovations and achieving objectives (e.g., a letter of commendation, recognition at a staff awards picnic, article in local news media, travel authorization to an out-of-town IPM conference, etc.).

### **Provide IPM educational materials and staff training programs**

IPM programs are information-intensive rather than treatment-intensive. This necessitates motivating pest control staff to try new approaches and broaden their professional skills. Build an IPM library of literature and training videos, and provide release time for staff to attend training seminars or take courses in pest identification.

## Box C

### Tips For Starting An IPM Program\*

The following suggestions will help overcome barriers and smooth the transition to IPM implementation.

Mandate staff training in IPM. When writing the IPM policy document, include a requirement for the continuing education of pest management personnel. Ensure that budgetary allocations are made to assist them in obtaining the information, skills, and equipment they need to carry out the policy.

Start small. Begin IPM implementation in one location (e.g., a kitchen in a single school, a section of lawn at a single school, etc.) and include short-term objectives. For example, when dealing with a number of pest problems, identify one of the pests likely to respond quickly to an IPM approach, such as cockroaches, so a short-term objective can be realized. Test the IPM methods and fine-tune them. When the program is working successfully in one area, or against one pest, expand the program further.

Develop a list of resources. Know where you can go when information is needed, and know when you need to seek outside help. County Agricultural Extension personnel, teaching staff in the biology or entomology departments of a nearby university, staff at the local zoo, and even the high school biology teacher can help identify pests and their natural enemies. As you talk to these people ask them if they know of experts in your particular pest problem. You can slowly compile a list of people whom you can call for advice. Appendix G can be the beginning of your resource list. Always post your local poison control center telephone number in a prominent place.

Build a library for pest management personnel, staff, and students to use. Agricultural Extension publications are usually free or inexpensive and can be good sources of information on pest biology. Even though these publications do not always recommend the least-toxic

approach, they are still useful. The recommended reading section of this manual lists many useful books. Although some of these books are not in print anymore, you may be able to obtain them from your local library. If your library doesn't have the book you are looking for, ask if they can find the book in another, larger library and borrow it through an inter-library loan.

Don't change everything at once. To the degree possible, retain communication and accountability procedures already in use. Tailor new record keeping and reporting forms to fit existing agency formats. Recycle existing equipment to uses consistent with IPM methods rather than immediately eliminating the equipment.

Share the process. Involve all members of the student body and staff, especially pest management personnel, in the day-to-day IPM program process as early as possible so they will understand and support the program during the sometimes difficult transition period.

Emphasize communication and plan for future training. During the IPM transition period, keep all personnel informed about what is planned, what is happening now, the expected outcome, and what will happen next. Prepare written records and visual aids that will remain in the school when persons associated with development of the IPM program are no longer there.

Publicize the program. Develop good rapport with district public relations personnel and with the local news media. For interviews and photo sessions, include pest managers, custodians, and landscape maintenance personnel as well as principals, school board members, and the superintendent.

Involve the community. Form an IPM advisory committee composed of interested parents, school staff, community organizations, health specialists, and pest control professionals. They can help make IPM implementation a budgetary priority in the district, and can donate or locate resources that may not otherwise be available to the school.

\*Adapted from Flint, et al. 1991

## Box D

### Sources of Pest Control Services\*

IPM programs can be successfully implemented by “in-house” school employees, by contracting with a pest control company, or by mixing and matching these options to meet the needs and capabilities of the school system. All three approaches have advantages and disadvantages, and individual school systems must decide what is best for them under their unique circumstances. Whatever way you choose to implement your program, pest management personnel should be trained to

- understand the principles of IPM
- identify structural features or human practices that are contributing to pest infestations and know how to permanently improve them to reduce pest problems
- identify pests and recognize the signs or symptoms of their presence
- monitor infestation levels and keep records of pests and treatments
- know how to successfully apply physical, mechanical, cultural, and biological pest control methods
- know the full array of least-hazardous pesticides registered for use
- know recommended methods of judicious pesticide application
- know the hazards of pesticides and the safety precautions to be taken; be familiar with the pesticide label’s precautionary statement(s) pertaining to exposure to humans or animals

#### “In-House” Services

One of the most important tasks for an in-house program is training staff to function within an IPM

context. Universities and State Cooperative Extension Services have the expertise to meet most IPM training needs. Training materials that are needed and are not already available can be developed jointly between the School District, the Cooperative Extension Service, and other resource organizations (see Appendix G).

#### Contracted Services

Pest control companies should work with the responsible school official to solve pest control problems. Using an outside pest control company may cost more initially than in-house staff, but has the advantages of not having to hire and train personnel, or, when necessary, incur the added costs of storing pesticides. The contract should specify the use of IPM principles and practices in meeting pest management objectives.

When choosing a pest control firm, local Better Business Bureaus or state regulatory agencies may provide information about whether they have or have not received complaints about a pest control company. State regulatory agencies can also provide information on pesticide applicator certification.

The pest management services contract should include IPM specifications. Contracts should be written to provide expected results. Pest management objectives specific to the site should be jointly developed, agreed upon, and written into the contract. Any special health concerns (such as those for old or young persons, for pets, or for individuals who are allergic, etc.) should be noted and reflected in the pesticides that can be utilized, or excluded from use. See Appendix D for sample contract performance specifications.

\*Adapted from U.S. EPA 1993

### Prepare an IPM operations manual

Written policies and procedures are needed to insure clarity about responsibilities, authorized activities, permitted materials, and other program elements. A manual serves as an accountability mechanism, and helps insure program continuity despite personnel changes.

A loose-leaf binder that allows for addition or deletion of materials over the years is a convenient format. In

addition to official policies, procurement practices, etc., the manual should specify the following:

- pest management objectives
- the overall IPM process for managing each pest
- biological and ecological information on the pest and its natural enemies
- the monitoring system for each pest (and natural enemies when appropriate)

- injury levels and action thresholds for pests
- the record keeping system to be used
- how to interpret field data
- how to obtain, use, and maintain equipment and supplies required to carry out monitoring and treatment activities
- the range of treatment tactics authorized for use against the pest and how to employ them
- a list of pesticides authorized for use in the district
- safety procedures and resources for emergencies
- how to evaluate treatment effectiveness

## **BUILDING SUPPORT FOR THE IPM PROGRAM**

Once an IPM policy has been adopted by a school board, it is up to the in-house pest control staff or outside contractors to implement the policy (see Box D for a discussion of pest control services and Appendix D for sample IPM contract specifications).

Change never comes easily, and there are a number of predictable obstacles within a school system—both psychological and institutional—to be overcome when initiating IPM programs. At the same time, even if the public has been involved with development of a policy, there are likely to be occasional complaints and controversies, especially as pests, pest control practices, and public concerns change.

## **PSYCHOLOGICAL BARRIERS TO IPM ADOPTION**

### **Psychological resistance to change**

#### **The Problem**

When pest control personnel are asked to make pest control decisions in a new way and to use new methods, they may feel that there is a negative implication regarding their past performance so they resist making the changes or drag their feet.

#### **How to Address It**

It is important to avoid an adversarial relationship with the school's personnel. If you want to secure their cooperation, you cannot think of them or portray them as "the bad guys." Pest control personnel will have information about current pests and pest control practices in the school as well as historical information that will be invaluable to you. Let them know that you consider their knowledge important and that you need their expertise in planning the implementation of the IPM program. Try to

foster a sense of team spirit and point out that a pilot IPM program at your school could be used as a model for other schools in the district.

### **Loss of authority**

#### **The Problem**

Adopting an IPM approach may engender fear of many kinds of loss, including loss of personal or supervisory authority. In the first case, individuals may fear that their experience in the field will become devalued, particularly if their expertise has been in pesticide application. In the second case, supervisors may fear that the system will become more efficient and they will lose positions beneath them.

#### **How to Address It**

Actually, successful IPM implementation enhances both personal and supervisory authority. Many of the new, less toxic pest control materials, such as pheromones, microbial and botanical pesticides, and insect growth regulators (IGRs) require the same or similar application skills and equipment as conventional pesticides. Mastering the techniques of monitoring, for example, enhances individual skills and can lead to an upgrading in job classification. In terms of supervisory authority, IPM programs provide managers with greater flexibility in staff assignments. For example, by emphasizing monitoring rather than prophylactic pesticide applications, staff time previously spent spraying can be redirected to other tasks, increasing overall productivity within a department.

### **Imagined difficulty in learning new technology**

#### **The Problem**

The techniques used in IPM may initially appear to require conceptual and operational skills beyond those of the current staff.

#### **How to Address It**

This fear can be overcome by building staff training into the IPM implementation program, and by establishing a transition period during which pest management personnel experiment with and fine-tune IPM methods. Once personnel have a basic understanding of IPM concepts, these people will become the source of the most useful innovations in pest management because they have the most extensive knowledge of how their system works.

### **Fear of IPM program failure**

---

## **The Problem**

Supervisory personnel may believe that the IPM program will not work for them even though it has been successful in a nearby school.

## **How to Address It**

In fact, IPM programs are designed for the particular circumstances of each location. While the IPM decision-making process remains the same no matter what the pest or site, the specific tactics and products used may vary greatly from one location or circumstance to another. This flexibility usually assures an appropriate solution to the pest problem.

## **INSTITUTIONAL BARRIERS TO IPM ADOPTION**

### **Fear that IPM means no access to pesticides**

#### **The Problem**

Some people think IPM means never using chemical controls.

#### **How to Address It**

While IPM definitely encourages alternatives to pesticides when feasible, chemical controls are used when necessary. However, in an IPM program, pesticides that are least-disruptive, most-selective to specific pests, and rapidly biodegrade are preferred over common, broad-spectrum materials. When chemical controls are used in an IPM program, every effort is made to “spot-treat” specific areas rather than spraying large areas.

### **Fears that IPM is more expensive than traditional pest control**

#### **The Problem**

Until agencies have experience with IPM, they expect it to cost more than their current program.

#### **How to Address It**

While there are short-term start-up costs for any new technology, in the long run IPM has usually proven more cost-effective than a strictly chemical control program. When possible, IPM programs substitute information gathering (monitoring) in place of other pest control activities, such as preventive pesticide applications. This can be very cost-effective. For example, by monitoring their 1100 elm trees rather than prophylactically spraying them against elm leaf beetles, the City of San Rafael, CA found that only a small portion of the trees required treatment. As a

result, the city saved \$1400 (including monitoring costs) in the first year of its IPM program, compared to the previous year when all trees were sprayed.

IPM methods emphasize reducing the source of pest problems (e.g., designing out pest habitat and food sources) rather than treating symptoms (e.g., spraying). This type of pest prevention program is more cost-effective than a continuing program of pest reduction that does not address the underlying cause of the infestation and is therefore repeated again and again. For example, by permanently reducing habitats for rats (i.e., by filling rat holes with concrete, changing the design of garbage cans, and increasing frequency of garbage pickup) the National Park Service was able to permanently reduce rat populations in certain parks. Previous rat control programs that had relied on poison baits had not been successful despite large expenditures of labor and money.

### **Lack of in-house IPM expertise**

#### **The Problem**

School staff may be unfamiliar with IPM and may not know where to go for information.

#### **How to Address It**

While it is true that IPM education and training resources are not as widely available as those for chemical controls alone, good resources can be found in any community. Many agencies have found it feasible to hire an IPM specialist to work as a consultant to in-house pest control staff during the initial year or two of IPM implementation, or to create an IPM coordinator position and recruit nationwide. Other sources of information include cooperative extension agents, college horticultural or entomological faculty, and pest control advisors. Periodicals providing practical technical advice on IPM methods for specific pest problems are increasingly available. See also the Recommended Readings section of this manual and Appendix G. Box E provides names and addresses of contacts who can help with questions of IPM program design and implementation.

## **BIBLIOGRAPHY**

- Bio-Integral Resource Center (BIRC). 1996. 1997 directory of least-toxic pest control products. *IPM Practitioner* 18(11/12):1-48.
- Boyd, S. et al. 1992. *Pesticides in our Communities: choices for change*. Concern, Inc., Washington, D.C. 31 pp. [Available from Concern, Inc., 1794 Columbia Road NW, Washington,

---

## Box E

### Contacts to Help Implement an IPM Program

Tim Rhay Consulting

916 Corydon St.

Eugene, OR 97401

(541) 687-5349 or 687-4800

Tim Rhay has been instrumental in developing and maintaining the IPM program for Eugene, OR, which has been a huge success. He is involved in doing presentations to pest control professionals, maintenance workers, and various state government workers. He operates a limited consulting business in IPM implementation, especially for athletic turf maintenance.

Mike Raup—(301) 405-3912

John Davidson—(301) 405-3927

Lee Hellman—(301) 405-3920

Department of Entomology

University of Maryland, College Park, MD 20742

All three have been part of a team of entomologists working for many years on implementing IPM programs in various environments. They have been involved in establishing demonstration homeowner sites; in working with commercial landscape professionals (where switching to IPM resulted in a 93% reduction in pesticide use), in nurseries and greenhouses, and in institutional settings. They have published reports on each of the programs they have implemented, including data on pesticide use reduction.

D.C. 20009; (202) 328-8160. Has extensive references to source literature on pesticide toxicology.]

Integrated Pest Management. Pub. No. 735-F-93-012. Office of Pesticide Programs (H7506C). Washington, D.C. 43 pp.

Flint, M.L., S. Daar, and R. Molinar. 1991. Establishing Integrated Pest Management Policies and Programs: a guide for public agencies. Univ. of California Statewide IPM Project. UC IPM Publication 12. University of California, Davis, CA. 9 pp.

Riley, B. Getting Pesticides out of Schools. NCAP, Eugene, OR. 30pp. [Available from NCAP, P.O. Box 1393, Eugene, OR 97440; (503) 344-5044.]

U.S. EPA 1993. Pest Control in the School Environment: Adopting



# APPENDIX C

## DEVELOPING AN IPM POLICY STATEMENT FOR SCHOOL PEST MANAGEMENT

A clear policy statement is needed to develop agreement about how pest control will be performed. The sample IPM policy included here does not exclude the use of a pesticide, but places all pesticide use within a context where such use will be minimized. A policy statement for school pest management should state the intent of the school administration to implement an IPM program and should briefly provide guidance on what specifically is expected. The sample policy statement below can be adapted and modified to fit your own situation. This model has been used by a wide variety of institutions and school districts as a way to resolve conflicts and redirect pest control efforts toward least hazardous practices.

### SAMPLE SCHOOL PEST MANAGEMENT POLICY STATEMENT

Structural and landscape pests can pose significant problems to people, property, and the environment; however, the pesticides used to solve these problems carry their own risks. It is therefore the policy of this School District to use Integrated Pest Management (IPM) programs and procedures for control of structural and landscape pests.

#### Pests

Pests are living organisms (animals, plants, or microorganisms) that interfere with human purposes for the school site. Strategies for managing pest populations will be influenced by the pest species and the degree to which that population poses a threat to people, property, or the environment.

#### Pest Management

Pests will be managed to

- reduce any potential human health hazard or to protect against a significant threat to public safety
- prevent loss or damage to school resources, structures or property
- prevent pests from spreading in the community, or to plant and animal populations beyond the school site
- enhance the quality of life for students, staff, and others

Pest management strategies must be included in an approved pest management plan for the site.

#### Integrated Pest Management Procedures

IPM procedures will determine when to control pests, and whether to use physical, horticultural, or biological means. Chemical controls are used as a last resort. IPM practitioners depend on current, comprehensive information on the pest and its environment, and the best available pest control methods. Applying IPM principles prevents unacceptable levels of pest activity and damage. These principles are implemented by the most economical means and with the least possible hazard to people, property, and the environment.

It is the policy of this School District to utilize IPM principles to manage pest populations adequately. While the goal of this IPM program is to reduce and ultimately eliminate use of toxic chemicals, toxic chemicals may become necessary in certain situations. The choice of using a pesticide will be based on a review of all other available options and a determination that these options are unacceptable or are infeasible, alone or in combination. Cost or staffing considerations alone will *not* be adequate justification for use of chemical control agents. The full range of alternatives, including no action, will be considered.

When it is determined that a pesticide must be used in order to prevent pest levels from exceeding action thresholds, the least-hazardous (see Box A) material will be chosen. The application of such pesticides is subject to the Federal Insecticide, Fungicide, and Rodenticide Act (7 USC 136 et seq.), School District policies and procedures, Environmental Protection Agency regulations in 40 CFR, Occupational Safety and Health Administration regulations, and state and local regulations.

#### Education

Staff, students, administrative personnel, custodial staff, pest managers, and the public will be educated about potential school pest problems and the integrated pest management policies and procedures to be used to achieve the desired pest management objectives.



## Record Keeping

Records will be kept on the number of pests or other indicators of pest populations both before and after any treatments. Records must be current and accurate if IPM is to work. Records of pesticide use shall be maintained on site to meet the requirements of the state regulatory agency and School Board, and records will also document any non-toxic treatment methods being used. The objective is to create records from which programs and practices can be evaluated in order to improve the system and to eliminate ineffective and unnecessary treatments.

## Notification

This School District takes the responsibility to notify students' parents or guardians and the school staff of upcoming treatments which will involve a pesticide. Notices will be posted in designated areas at school and sent home with students.

## Pesticide Storage and Purchase

Pesticide purchases will be limited to the amount authorized for use during the year. Pesticides will be stored and disposed of in accordance with the EPA-registered label directions and State or Local regulations. Pesticides must be stored in an appropriate, secure site not accessible to students or unauthorized personnel. A cabinet in a non-student area with a locked and labeled door is advised. The door label should include a skull and crossbones, Mr. Ugh, or other visual signals for non-English reading adults or children.

## Pesticide Applicators

Pesticide applicators must be educated and trained in the principles and practices of IPM and the use of pesticides approved by this School District, and they must follow regulations and label precautions. Applicators must be certified and comply with this School District IPM Policy and Pest Management Plan. Under no circumstances should applications be made while school or school activities are in progress.

## Box A

### Cautionary Labeling for Pesticides

Law requires that precautionary statements and signal words be included on all pesticide labels. The signal words (see below) indicate the level of acute (immediate) toxicity of the pesticide to humans. The chronic (long-term) toxicity is not indicated on the label. Note that chronic toxicity may be important for materials used frequently or extensively, or used in areas where children may receive regular whole-body exposure (for example, lawns on which young children play, sit, and lie). Chronic toxicity information must be obtained from scientific papers that are published in scientific journals. Every label bears the child hazard warning "Keep Out of Reach of Children."

### Signal Words

If none of these warnings is provided do not use the pesticide.

**DANGER**-A taste to a teaspoonful taken by mouth could kill an average-sized adult.

**WARNING**-A teaspoonful to an ounce taken by mouth could kill an average-sized adult.

**CAUTION**-An ounce to over a pint taken by mouth could kill an average-sized adult.

Note that these warnings are expressed as amounts taken by mouth; however, most actual exposure is through skin and lungs. Thus, this system is not sufficient to guarantee safety; it is only one indicator. No materials with the DANGER indication should be used near children. It also follows that WARNING materials should be used only rarely on pests for which no CAUTION materials are registered. Whenever additional information is available about chronic toxicity it should be used to compare different materials to choose the least-toxic pesticides.

---

# APPENDIX D

## INTEGRATED PEST MANAGEMENT (IPM) CONTRACT PERFORMANCE SPECIFICATIONS\*

### GENERAL PROGRAM DESCRIPTION

It is the intent of this contract to provide a comprehensive Integrated Pest Management (IPM) program for the property listed herein. IPM is a relatively new concept in urban areas. Traditional structural pest control is largely reactive to pest infestations and bases much of its response on routinely scheduled application of pesticides. Routine applications are probably unnecessary, and have limited effectiveness in providing adequate long-term control.

Conversely, IPM is a decision-making process for achieving long term pest suppression. In the IPM process, monitoring and the interpretation of data gathered provide estimates of the pest population in a given area. This monitoring allows accurate decisions to be made about when intervention measures are needed, the type of control measure selected, and the method of application. Pest management practices in an IPM program extend beyond the application of pesticides to include structural, procedural, and landscape modifications. These practices establish physical barriers to pests, reduce the food, water, and harborage available to them, and establish landscape plants and designs which require less maintenance.

The Contractor shall furnish all labor, materials and equipment to implement the monitoring, trapping, and pesticide application aspects of the IPM program. The Contractor shall also make detailed, site-specific recommendations for structural and procedural modifications to achieve pest suppression. The Contractor shall provide evidence in his/her proposal of sufficient expertise in pest control, and IPM principles and practices to effectively carry out these responsibilities.

The School District Pest Manager (SDPM) will act as the manager of the IPM program, which will include overseeing and monitoring contract performance.

### Pests Included and Excluded

The IPM program specified by this contract is intended to suppress the population of rats, mice, cockroaches, ants, silverfish, and any other pest included in the contract. Populations of these pests which are located outside the buildings listed herein, but within the property boundaries of the buildings, are included.

### GENERAL PROGRAM REQUIREMENTS

General requirements of the IPM program shall include the following for each site specified in this contract:

#### Initial Inspection

A thorough, initial inspection shall be conducted during the first month of this contract by the Contractor's representative, Property Manager or representative, and SDPM. The purpose of this initial inspection is to allow the contractor to evaluate the pest management needs of the property and to discuss these needs with the Property Manager and SDPM. The following specific points should be addressed:

- identification of problem areas in and around the building
- identification of structural features or personnel practices that are contributing to pest infestations
- discussion of the effectiveness of previous control efforts
- facilitation of Contractor access to all necessary areas
- informing the Contractor of any restrictions or special safety precautions, or other constraints

#### Submission of Plan

Following the initial inspection, the Contractor will develop a detailed Pest Management Plan and Service Schedule for each property. This written plan and schedule must be submitted to the SDPM for approval prior to initiation. The plan and schedule must address the following:

- the structural and operational actions to inhibit pests
- the Contractor's means for monitoring pest populations in and around the building
- the proposed primary pesticides (accepted common name and generic name) and alternatives approved by the Environmental Protection Agency (EPA)
- the conditions requiring application
- the method(s) of application proposed
- the rationale for each type of use

\*Adapted from contract specifications prepared for the Federal Government General Services Administrator by Dr. Albert Green and colleagues.

- 
- the proposed trapping devices for rodents, if any

Frequency of inspections, monitoring, and treatment by the Contractor shall depend on the specific pest management, needs of the premises. At the minimum, inspections and monitoring shall be done monthly.

The Plan and Schedule shall be submitted not more than 10 working days following the initial inspection of the premises. The SDPM will render a decision regarding the acceptability of the Plan and Schedule within 10 working days following receipt. The Contractor shall be on site to implement the Plan and Schedule within 5 working days following notice of approval of the plan. If the Plan is disapproved, the Contractor shall have 3 working days to submit a revised Plan and Schedule.

Any subsequent changes in the Plan and Schedule must receive the concurrence of the SDPM.

The Contractor shall describe, in the proposal, the capability of meeting emergency and special service requests (e.g., radio-dispatched service, names of office personnel handling the account, availability of trucks and personnel, etc.).

### **Monitoring and Inspection**

A critical aspect of the Pest Management Plan shall be the establishment of a monitoring and inspection program to identify infested zones and allow an objective assessment of pest population levels. Monitoring and inspection shall be continued throughout the duration of this contract. The Contractor shall describe in the proposal the approach to meet this requirement. Where appropriate, glue traps shall be employed to monitor cockroach populations in selected areas.

### **Pesticide Treatment**

The Contractor shall not apply any pesticide which has not been specifically approved by the SDPM. In cooperation with the SDPM, the Contractor shall develop action thresholds specific to each pest and to site zones.

As a general rule, application of pesticides in any area inside or outside the premises—i.e., in any room, closet, hallway, stairwell, court, driveway, planting bed, and similar locations—shall not occur unless inspections or monitoring indicate the presence of pests that exceed action thresholds in that specific area. Signs of pest activity must be seen and identified. For instance, a relatively fresh rodent dropping or an active burrow or runway is sufficient to indicate the

presence of rodents in an area. Use and effectiveness of alternative non-pesticidal pest management methods must be documented in monitoring records prior to requesting the use of pesticides.

Preventive pesticide treatments of inside and outside areas where inspections indicate a potential insect or rodent infestation are generally unacceptable. In exceptional circumstances, however, preventive pesticide treatment may be allowed on a case-by-case basis. The Contractor must substantiate the need, indicating areas for preventive treatment in the Pest Management Plan for the building, and listing the preventive treatment methods of application. Each preventive treatment is subject to approval by the SDPM and can be eliminated by him/her at any time.

### **Structural Modifications**

Structural modifications for pest suppression shall not be the responsibility of the Contractor. However, the Contractor is responsible for notifying the SDPM about structural modifications necessary to prevent access by pest populations, or for safety reasons.

### **Record Keeping**

The Contractor shall be responsible for maintaining a complete and accurate Pest Management Log Book. Each property specified in this contract shall have its own Log Book which will be kept in the Property Manager's office and maintained on each visit by the Contractor.

The Log Book shall contain the following items:

- A copy of the Pest Management Plan and Service Schedule for the property.
- A copy of the current label and EPA registration number for each pesticide used in the building, including the Material Safety Data Sheet.
- Pest monitoring data sheets which record, in a systematic fashion, the number of pests or other indicators of pest population levels revealed by the Contractor's monitoring program for the building, e.g., number and location of cockroaches trapped, number and location of rodents trapped or carcasses removed, number and location of new rat burrows observed, etc. The Contractor shall provide, in the proposal, a sample of the format for the data sheets and an explanation of all information to be recorded on them.
- The location of all traps, trapping devices, and bait

---

stations in or around the property. This information can be in either tabular or in list format, and should be accompanied by a map for each pest.

- The Property Manager’s copies of a Pest Control Work and Inspection Report Form. These forms will be supplied to the Contractor to advise the Contractor of routine service requests and to document the performance of all work, including emergency work. Upon completion of a service visit to the building, the Contractor’s representative performing the service shall complete, sign, and date the Form and return it to the Property Manager’s office on the same or succeeding day of the performance of the service.
- The Contractor’s Service Report forms, documenting arrival and departure time of the Contractor’s representative performing the service, and all record keeping information on pesticide application required by the FIFRA statute. These report forms may incorporate some or all of the pest monitoring data required above.

### **Special Requests and Emergency Service**

The regular service shall consist of performing all components of an IPM program other than structural modifications, as described in the Contractor’s detailed Plan and Schedule for each property, during the period of the contract. Occasional requests for corrective action, special services beyond the routine requests for emergency service shall be placed with the Contractor. The Contractor shall respond to requests for emergency service on the day of the request. The Contractor shall respond to special service requests within one (1) working day after receipt of request. In the event that such services cannot be completed within their time frames, the Contractor shall immediately notify the SDPM and indicate an anticipated completion date.

## **SPECIFIC PROGRAM REQUIREMENTS AND RESTRICTIONS**

### **Personnel**

The Contractor shall provide only qualified pest management personnel with adequate experience in the conduct of IPM programs. All personnel must understand current practices in this field and be able to make judgments regarding IPM techniques. Training and experience in IPM must be demonstrated.

Any proposed deletions, additions, or replacement of personnel from those cited in the Contractor’s original proposal must be submitted, in writing, to the SDPM and

approved prior to their becoming a part of this contract.

The contractor must meet the following specific staff requirements:

### **Entomologist**

The Contractor shall have a staff Entomologist, or access to one, available for routine and emergency consultation. Evidence of the following documentation regarding this individual’s experience and training shall be provided in the proposal:

- Bachelor’s degree in entomology from an accredited University; or a Bachelor’s degree in biology, chemistry, or other life science and proof of membership in the American Registry of Professional Entomologists (ARPE).
- Current certification in the appropriate jurisdictions as a Commercial Pesticide Applicator in the category of Industrial, Institutional, Structural, and Health Related Pest Control with a minimum of subcategories to include General Pest Control, Rodent Control, and Turf and Ornamental.

### **Supervisor**

A Supervisor and an alternate must be identified in the proposal. The on-site Supervisor shall have the Contractor’s authority to act on matters pertaining to the performance of services required under this contract. This individual shall assure safety and carry out coordination and continuity of the program routine. The Supervisor and alternate shall both have a working knowledge of this contract and the detailed Pest Management Plan and Schedule for each building. The Supervisor and alternate must both meet the qualifications identified below under Pest Management Technicians.

### **Pest Management Technicians**

The Contractor shall provide, in the proposal, the names of all pest management personnel assigned to this contract, and pertinent information regarding their qualifications, experience, and training. Throughout the life of this contract, all personnel providing on-site pest management services must be certified in the appropriate jurisdictions as Commercial Pesticide Applicators in the category of Industrial, Institutional, Structural, and Health Related Pest Control. No uncertified personnel will be permitted to work on-site under this contract unless under the supervision of a certified applicator.

### **Manner and Time to Conduct Services**

---

It shall be the Contractor's responsibility to carry out work according to the detailed Pest Management Plan and Schedule developed for each property. The Contractor's on-site Supervisor shall be responsible for coordination with the Property Manager or representative at the beginning of each visit. The purpose of this coordination is to review the plan and schedule, and to receive information on problem areas needing corrective action.

Services which are not likely to adversely effect tenant health or productivity may be performed during the regular hours of operation in the various buildings. Pesticide applications (except bait placement), however, shall not be made during school hours, or during normal work hours of school staff. When it is necessary to perform work on weekends or outside the regularly scheduled hours set in the Contractor's Plan and Schedule, the Contractor shall notify the SDPM and the Property Manager at least 2 days in advance and all arrangements will be coordinated between the SDPM, the Property Manager, and the Supervisor.

Where service to vacated areas is required, it shall be the Contractor's responsibility to notify the SDPM and the Property Manager at least 2 days in advance of the treatment, provide and post all necessary signs (such as when an area may be reentered—in case of pesticide use, according to the product's label directions) and remove signs when the area is safe for entry.

The Contractor shall observe all safety precautions throughout the performance of this contract. Certain areas within some buildings may require special instructions for persons entering the building. Any restrictions associated with these special areas will be explained, in writing, to the Contractor and SDPM by the Property Manager or representative. These restrictions shall be adhered to and incorporated into the Contractor's detailed plan and schedule for the property.

All Contractor personnel, working in or on properties designated under this contract, shall wear distinctive uniform clothing. The uniform shall have the Contractor's name easily identifiable, affixed thereon in a permanent or semi-permanent manner. Additional personal protective equipment required for the safe performance of work must be determined and provided by the Contractor. Protective clothing, equipment, and devices shall as a minimum, conform to Occupational Safety and Health Administration (OSHA) standards for the products being used. Vehicles used by the Contractor must be identified in accordance with

State and local regulations.

### **Pesticide Products and Use**

The Contractor shall be responsible for the proper use of pesticides. All pesticides used by the Contractor must be registered with the EPA and State and/or local jurisdiction. Transport, handling, and use of all pesticides shall be in strict accordance with the manufacturer's label instructions and all applicable Federal, State, and local laws and regulations. The Contractor will follow all notification and warning procedures required by the SDPM prior to the application of a pesticide. The environment and the public shall be protected at all times.

The Contractor shall minimize the use of synthetic organic pesticides wherever possible. Alternatives are

- The use of crack and crevice application of pesticide to pest harborage areas rather than fan spraying exposed surfaces in the general vicinity of harborage areas.
- The use of containerized bait such as boric acid, for cockroaches, rather than sprays, wherever appropriate.

Pesticide fogs and sprays (including mists and ultra-low volume applications) will be restricted to unique situations where no alternative measures are available or practical.

In the unusual event that a space spray application is required, and prior to performing a space spray treatment, the Contractor shall submit a written request for approval to the SDPM at least 2 days prior to the proposed treatment time. The request must identify the target pest, document the need for such treatment, the time (when site is not occupied) and specific place(s) of treatment, the pesticide(s) to be used, the method of application, what precautions should be taken to ensure tenant and employee safety, and the steps to be taken to ensure the containment of the spray to the site of application. No space application of pesticides shall be made without the written approval of the SDPM. No space application of pesticide shall be made while tenant personnel are present. Products identifiable as fumigants shall be considered inappropriate for use and shall not be used in any space for any purpose, unless it determined that an emergency exists by the SDPM.

### **Rodent Control**

Snap traps and trapping devices (including glueboards) used in rodent control must be checked daily. The

---

Contractor shall dispose of rodents killed or trapped within 24 hours. Trapping shall not be performed during periods when maintenance will be delayed by holidays, weekends, etc. Traps shall be placed out of the general view and located so as not to be affected by routine cleaning procedures.

All rodenticides, regardless of packaging, shall be placed either in locations not accessible to children, pets, wildlife, and domestic animals, or in EPA-approved tamper-resistant (often termed “tamper-proof”) bait boxes. Frequency of bait box servicing shall depend upon the level of rodent infestation. All bait boxes shall be labeled, and dated at the time of installation and each servicing. All bait boxes shall be maintained in accordance with EPA regulations, with an emphasis on the safety of non-target organisms. The following points shall be strictly adhered to:

- The lids of all bait boxes must be securely locked or fastened shut.
- Bait must always be placed in the baffle-protected feeding chamber of the box and never in the runway of the box. Bait may be placed inside an active rodent burrow if the burrow entrance (and the bait) is then buried or caved-in to avoid non-target access to the bait.
- All bait boxes must be securely attached or anchored to the floor, ground, wall, etc., so that the box cannot be picked up or moved.
- Baits, bait boxes, and stations should only be considered as a last option for use inside buildings or school structures.

All traps, trapping devices, and bait boxes shall be accounted for, and their location recorded in the property Log Book; all shall be removed from the premises covered by this contract at its conclusion.

### **Inspection**

Throughout the duration of this contract, the premises covered will be inspected periodically by the SDPM to determine the effectiveness of the program and Contractor compliance with the contract. Inspection results will be documented in writing. The Contractor shall promptly initiate actions within 5 working days to correct all contract performance deficiencies found by the SDPM.

It shall be the Contractor’s responsibility to furnish an adequate supply of materials necessary to inspect the

interior of all rodent bait stations. These materials may include wrenches to loosen and tighten fasteners, keys to open locks, or replacement self-locking plastic ties. Implements to cut plastic ties or seals are not included under this provision.

### **Related Services**

The School District reserves the right to negotiate with the Contractor for the purpose of related pest control services not specifically covered herein, such as subterranean and structural management of termites and other wood-boring insects, or bird control, and to add (or delete) properties or parts of properties to the contract.

## **BID SUBMITTAL**

### **Pre-Bid Building Inspection**

All prospective bidders shall conduct a thorough and complete investigation of each property prior to submitting their proposal.

### **Selection for Award**

Bidders should be aware that the School District will perform a “best-buy analysis” and the selection for award shall be made to the bidder whose proposal is most advantageous to the School District, taking into consideration the technical factors listed below and the total proposed cost across all contract periods.

### **Technical Evaluation Criteria**

The technical portion of the proposal will be the most important consideration in making the award; therefore, the proposal should be as complete and as specific as possible.

The merits of each proposal will be carefully evaluated in terms of the requirements and in relation to the criteria established below. The evaluation will take into consideration the technical and administrative capabilities of the bidders in relation to the needs of the program and reasonableness of costs shown in relation to the work to be done.



---

# APPENDIX E

## SAMPLE MONITORING FORMS

You will find the following forms in Appendix E:

- 1) Roach Trap Monitoring
- 2) An example of how to fill out a Roach Trap Monitoring form
- 3) Landscape Monitoring
- 4) An example of how to fill out a Landscape Monitoring form
- 5) Plant Condition and Pest and Plant Damage Abundance Charts (for use with the Landscape Monitoring form)
- 6) Pest Control Trouble Call Log
- 7) Weed Monitoring Form for Turf

Also included is a sample floor plan of a building.

These forms can be used as they are, or they can be modified to fit your particular circumstances.



# Roach Trap Monitoring

Building # \_\_\_\_\_

Room or Area \_\_\_\_\_ Name of person monitoring \_\_\_\_\_

Trap #	Room # or Name	Date trap was		Trap Read Missing?	Location Description	Roaches		Total
		Set	Read			Adults	Nymphs	

\_\_\_\_\_ Total # of Traps      \_\_\_\_\_ Average # of Roaches/Trap (total # of roaches divided by total # of traps)      \_\_\_\_\_ Total # of Roaches

# Roach Trap Monitoring

Building # 3

Room or Area Cafeteria

Name of person monitoring John Doe

Trap #	Room # or Name	Date trap was		Trap Read Missing?	Location Description	Roaches		T
		Set				Adults	Nymphs	
1	Kitchen	3/5	3/26		SE Drain, under grate	0	0	0
2	Kitchen	"	"		S Sink under electric box	1	1	2
3	Dishroom	"	"	yes	S under conveyor belt	-	-	-
4	Dishroom	"	"		N under conveyor belt	0	0	0
5	Storage	"	"		left side of door	0	0	0
6	Dining	"	"		W serving counter	0	2	2

EXAMPLE

6 Total # of Traps Average # of Roaches/Trap 0.66 Total # of Roaches 4  
(total # of roaches divided by total # of traps)

# Landscape Monitoring

Name of Person Monitoring \_\_\_\_\_ Date \_\_\_\_\_

Describe location of appropriate category:

- Ornamental beds \_\_\_\_\_ Fence Lines \_\_\_\_\_
- Sport turf \_\_\_\_\_ Paved Areas \_\_\_\_\_
- Ornamental turf \_\_\_\_\_ Trees \_\_\_\_\_
- Playground \_\_\_\_\_ Other \_\_\_\_\_

Name of Plant	Condition of Plant			Name of Pest (if any are present)	Abundance of Pests   Plant Damage		Presence of Natural Enemies	Management Activities	Comments
	Excellent	Fair	Good		Poor	Common			

\*See accompanying charts for explanation

# Landscape Monitoring

Date 6/15

Name of Person Monitoring John Doe

Describe location of appropriate category:

Ornamental beds Fence Lines  
 Sport turf Paved Area  
 Ornamental turf Trees Northwest corner of school entrance  
 Playground Other

Name of Plant	Condition of Plant			Name of Pest (if any are present)	Abundance of Pests		Presence of Natural Enemies	Management Activities	Comments
	Excellent	Fair	Good		Poor	Common			
Blue Spruce	Good			Coolley Spruce Gall Aphid	Common	Common	None	Pruned 80% of Galls of tree	Continue monitoring

**EXAMPLE**

\*See accompanying charts for explanation

## Charts for Use with the Landscape Monitoring Form

### Plant Condition Chart

PLANT CONDITION RATING	INDICATORS OF PLANT CONDITION			
	Leaf Color	Amount/Size of Growth	Damaged Plant Parts	Presence of Pest Problems
<b>EXCELLENT</b>	Good	Adequate	None to few	No major ones
<b>GOOD</b>	Good	Slightly reduced	Few to common	A few minor ones
<b>FAIR</b>	Poor	Much reduced	Common to abundant	Either major <u>or</u> minor ones occurring frequently
<b>POOR</b>	Poor	Severely reduced	Innumerable	Both major <u>and</u> minor ones occurring frequently

**Leaf Color** Note that there are healthy plants that do not have bright green leaves. Leaves can be purple, yellow, or sometimes a mottled yellow and green (variegated). "Good" leaf color will not always be the same; it will depend on the kind of plant.

**Amount/Size of Growth** This refers to the length of the new growth for the season as well as the number of new leaves, and the size of the leaves, flowers, or fruit.

**Damaged Plant Parts** Look at the whole plant. Are there leaves with holes, spots, or discolorations? Are there wilted or dead leaves? Are there dead twigs or branches? Is the damage only on old leaves while new leaves look perfectly healthy?

**Presence of Pest Problems** A major pest problem is one that has seriously affected or injured the plant and requires management. A minor pest problem may or may not have affected or injured the plant and may or may not require management.

### Pest and Plant Damage Abundance Chart

Abundance Rating	Indicators of Abundance
FEW	Organisms or plant damage occasionally found, but only after much searching
COMMON	Organisms or plant damage easily found during typical searching
ABUNDANT	Organisms or plant damage found in large numbers—obvious without searching
INNUMERABLE	Organisms or plant damage extremely numerous—obvious without searching

These charts were adapted from Michigan State University's *Pest Management Manual*

**Pest Control Trouble Call Log**

<b>Trouble Calls</b>					<b>Pest Management Response</b>		
<b>Date</b>	<b>Building</b>	<b>Problem Description</b>	<b>School Contact Phone</b>	<b>Date</b>	<b>PCO Name</b>	<b>Action Taken</b>	<b>Materials* Used &amp; Amounts Used</b>

\* Pesticides, caulk, trap

## Weed Monitoring Form for Turf\*

Location of Turf \_\_\_\_\_ Date \_\_\_\_\_

Data collected by \_\_\_\_\_ Length of Pace \_\_\_\_\_

Distance between sampling points on transect \_\_\_\_\_  
*(for example, every nine paces)*

Number of transects \_\_\_\_\_ Length of transects \_\_\_\_\_

Sketch of location of transects

Transect A				Transect B				Transect C				I.D.	
Yes	No	Bare	Weed I.D.	Yes	No	Bare	Weed I.D.	Yes	No	Bare	Weed I.D.		
1				1				1					
2				2				2					
3				3				3					
4				4				4					
5				5				5					
6				6				6					
7				7				7					
8				8				8					
9				9				9					
1 0				1 0				1 0					
1 1				1 1				1 1					
1 2				1 2				1 2					
1 3				1 3				1 3					
1 4				1 4				1 4					
1 5				1 5				1 5					
1 6				1 6				1 6					
1 7				1 7				1 7					
1 8				1 8				1 8					
1 9				1 9				1 9					
2 0				2 0				2 0					

Average % weed growth \_\_\_\_\_ Average % bare area \_\_\_\_\_

*Total the number of boxes marked 'Yes' in each column. Multiply this number by 100 and divide by 60 (the total number of samples taken). The result is the average percentage of weeds growing in the turf area. Follow the same procedure to calculate percentage of bare area.*

\* For information on how to use this form, see Chapter 10, Box 10-B

# Sample Building Floor Plan

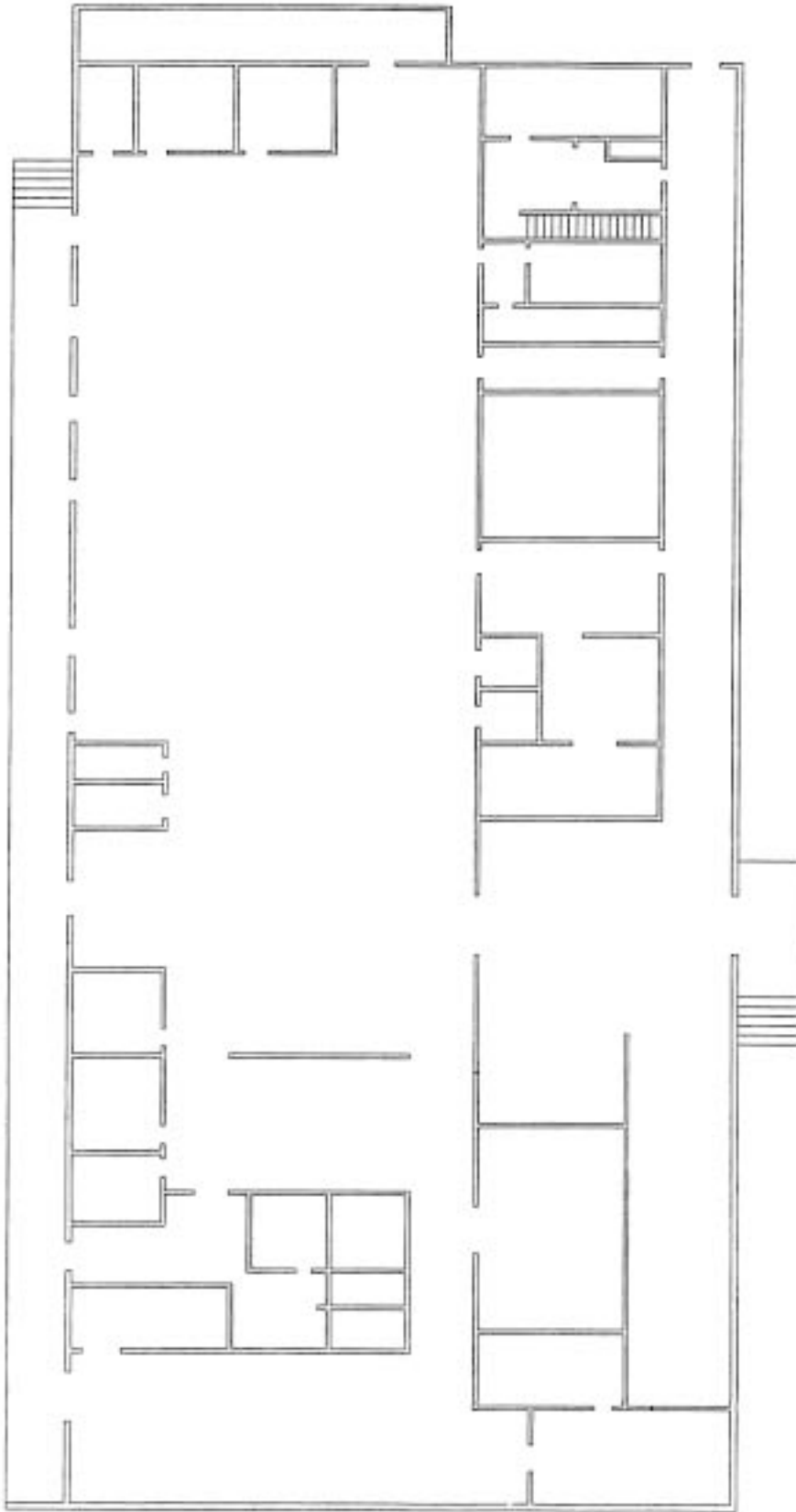

**BUILDING 12**  
FIRST FLOOR

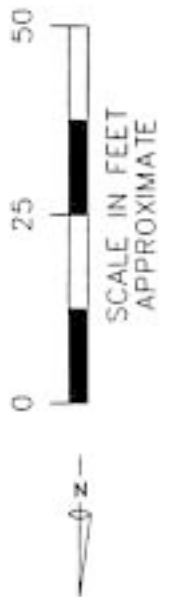



---

## APPENDIX F

# HOW TO COLLECT AND PRESERVE SPECIMENS FOR IDENTIFICATION

If your pest problem is common in your area, Cooperative Extension personnel may be able to confirm your identification over the phone just from your description of the organism and/or the damage it caused. Sometimes, however, they must inspect the specimen directly.

### Collecting Insects and Mites for Identification

Whenever possible, ask how your identification specialist would like the specimens preserved, and try to collect more than a single specimen. If you aren't able to ask about preservation before you collect, the following are good guidelines.

Larger insects (those larger than aphids) or insects with hard bodies should be placed in an appropriately sized plastic container, such as a pill bottle or film canister. Do not use the original cap; instead, stopper the bottle tightly with cotton. (Be careful not to crush the insect with the wad of cotton.) The cotton prevents moisture from accumulating inside the container and encouraging mold that can destroy important characteristics needed for identification. If the captured insects are still alive inside the bottle, place the container in the freezer for a day or two to kill them. If you are mailing the specimen to someone for identification, you must make sure the insects are dead. It is not a good idea to send live insects, because they may escape and cause a pest problem where you are sending them, particularly if they are not already present there. To mail the bottle, gently push the cotton wad down almost to the bottom of the bottle to prevent the insects from rattling around and losing body parts, then place the bottle in a box stuffed with crumpled newspaper.

Smaller organisms or organisms with soft bodies, such as aphids or mites, can be picked up with a paint brush and dropped into a small amount of rubbing alcohol in a container. In a dry container they might escape by tunneling around the cotton stopper or become entangled in the cotton, which can impair identification. Alternatively, insects and mites, even soft-bodied species such as aphids, can be left to dry out in a container and the identification specialist can rehydrate them for study

later.

### Collecting Plant Specimens for Identification

If you want to have a damaged plant inspected or a weed identified, place the plant and a moist paper towel inside a plastic bag. If you are unable to deliver the specimen in person, place the bag inside a padded mailing envelope. If you cannot mail the specimen immediately, however, it is likely to shrivel or mold. In that case, use the process outlined below.

### Preserving a Plant Specimen

Plants preserved in this manner can also be kept in a file for future reference regarding weeds, pest damage symptoms, etc.

Find a stiff index card or piece of white poster board large enough for the specimen, then cut a piece of clear contact paper that overlaps the card 3/4 inch on all sides. A sheet of aluminum foil spread over the work surface will prevent the contact paper from sticking in the wrong place. Separate the backing from the contact paper and lay the paper over the plant, pressing out air bubbles by moving your hand from the bottom to the top.

Cut off the corners of the contact paper, then fold the paper over the back of the card. Write the name of the weed (if known), the date, and the location where it was collected on the back.

### Keeping a Record

If you send a sample specimen for identification, we suggest you keep another for your own reference, because samples are not always returned. Along with the sample, you should send records of potentially important information about the situation or problem surrounding the specimen. Keep a copy of this information for yourself. We suggest you follow this format:

- date the specimen was collected
- place or address where the specimen was collected

- 
- specific area where the specimen was collected (e.g., “north side of the house,” “under a stone,” etc.)
  - maintenance practices that might have a bearing on the situation (e.g., “watered lawn two days before”)
  - previous pest control efforts (e.g., “used insecticidal soap spray morning of problem”)
  - host plant, if the insect was found on a plant
  - weather, if it seems relevant (e.g., “rained night before”)
  - time, if it seems relevant

---

# APPENDIX G

## PESTICIDE INFORMATION RESOURCES

Product manufacturers can provide information on hazards, efficacy, and safe disposal of pesticides. They are required to provide the public with a sample label and an MSDS (material safety data sheet) on request.

Cooperative Extension personnel (look in the government section of your phone book under Cooperative Extension) can provide information on the hazards and efficacy of pesticides. If you have questions about the pesticides that are registered against your particular pest, they can provide you with up-to-date information. The Cooperative Extension office also provides services for insect identification.

The National Pesticide Telecommunications Network (NPTN) operates a toll-free hotline, staffed by toxicologists, to provide the general public as well as the medical, veterinary, and other professional communities with the following:

- information on recognizing and managing pesticide poisonings
- tips for correctly using pesticides, especially household and professionally-applied pesticides
- referrals for laboratory analyses and investigation of pesticide incidents
- emergency treatment information
- pesticide clean-up and disposal procedures

NPTN/Department of Agricultural Chemistry  
Oregon State University  
Corvallis, OR 97331-7301  
(800) 858-7378

---

### Information on Pesticides

The following non-profit organizations provide information on pesticides. These organizations are funded by memberships and donations. Information is provided for small fees.

NCAMP—National Coalition Against the Misuse of Pesticides  
701 “E” St., SE  
Washington, D.C. 20003-2841  
(202) 543-5450

- educates interested parties on the toxicity and health effects of pesticides
- sells chemical fact sheets
- collects records of poisonings and environmental illnesses
- provides referrals to expert witnesses specializing in toxicology and multiple chemical sensitivity (MCS)

NCAP—Northwest Coalition for Alternatives to Pesticides  
P.O. Box 1393  
Eugene, OR 97440  
(541) 344-5044

- answers questions on pest problems, pesticides, and alternatives
- sells chemical fact sheets and IPM packets for schools
- publishes the Journal of Pesticide Reform

NYCAP—New York Coalition Against the Misuse of Pesticides  
P.O. Box 6005  
Albany, NY 12206-0005  
(518) 426-8246

- publishes a quarterly newsletter
- can provide information on setting up a school IPM program
- trains interested parties in IPM for both home and public property (includes office buildings and golf courses)

---

PANNA—Pesticide Action Network North America

116 New Montgomery St., Suite 810

San Francisco, CA 94105

(415) 541-9140

- clearinghouse for pesticide information
- will conduct library searches for a fee
- provides pesticide updates as they pertain to current media events
- provides referrals for pesticide alternatives
- concerned with international pesticide policy especially in South and Central America

Pesticide Education Center

Dr. Marion Moses

P.O. Box 420870

San Francisco, CA 94142-0870

(415) 391-8511

- well-informed about the health hazards of pesticide exposure
- strong emphasis on women and children

Pesticide Watch Education Fund

116 New Montgomery Street, Suite 530

San Francisco, CA 94105

(415) 543-2627

- provides information on pesticides and alternatives
- publishes a quarterly newsletter
- offers advice on how to build support for IPM programs in schools, parks, and other locations
- offers referrals to technical experts

The Rachel Carson Council

8940 Jones Mill Rd.

Chevy Chase, MD 20815

(301) 652-1877

- publishes “Basic Guide to Pesticides”
- pesticide legislation advocacy group

---

---

## Information on Alternatives

The following non-profit organizations can provide information on alternatives to pesticides. These organizations are funded by memberships and donations. Information is provided for small fees.

The Bio-Integral Resource Center (BIRC)

P.O. Box 7414

Berkeley, CA 94707

(510) 524-2567

- can provide information and/or publications on least-toxic methods for managing any pest
- publishes two journals: The IPM Practitioner and Common Sense Pest Control Quarterly
- publishes Directory of Least-Toxic Pest Control Products which is updated yearly (included in pocket on next page)
- provides consultation and training in IPM

NCAP—Northwest Coalition for Alternatives to Pesticides

P.O. Box 1393

Eugene, OR 97440

(541) 344-5044

(see preceding section for description)

---

Pesticide Watch Education Fund  
116 New Montgomery Street, Suite 530  
San Francisco, CA 94105  
(415) 543-2627  
(see preceding section for description)

Washington Toxics Coalition  
4516 University Way, NE  
Seattle, WA 98105  
(206) 632-1545

- provides technical information, strategies, and alternative management policies to people working to protect human health and the environment
- offers the “Buy Smart, Buy Safe” consumer guide to least-toxic products (20 pp.)
- sells “Home Safe Home” fact sheets on toxics and their alternatives in and around the home
- sells industrial toxics reduction fact sheets



---

# APPENDIX H

## HEAD LICE INFORMATION PACKET FOR SCHOOLS

This Sample Information Packet contains the following:

- 1) Facts about Head Lice
- 2) Recommendations for How to Treat Head Lice
- 3) How to Comb for Head Lice
- 4) Sample Letter from School to Parents

These materials may be reproduced by any school in part or as a whole and may be modified to suit particular situations.

---

## Facts about Head Lice (Pediculosis)

People have many false ideas about head lice.

1. Head lice are not a reason for panic or extreme measures.
2. Head lice are not a sign of uncleanness.
3. Head lice do not favor any particular socio-economic level—they attack rich and poor alike.
4. Head lice are not something to be ashamed of.
5. Head lice do not carry serious diseases.
6. Head lice cannot jump or fly.
7. Head lice cannot live on pets.

Head lice infest the hair, suck blood from the scalp, lay their eggs (commonly known as nits) on the hair shafts, and cause itching and some additional discomfort when present in large numbers.

They are very easily transmitted from one person to another, primarily by close personal contact with head hair. They can also be transmitted by sharing personal items like combs, hair brushes, hats, or other articles of clothing on which infested strands of hair or adult lice are present. Rugs and upholstered furniture can sometimes be a source of hair strands with nits.

Below are drawings of an adult louse (1/8" long, yellowish-grey), a nit (1/3" long), and hair debris that can be mistaken for nits. The eggs are white when they are first laid and darken to a coffee color before they hatch.

Notice that nits are always oval-shaped and attached to only one side of the hair shaft, usually close to the scalp.

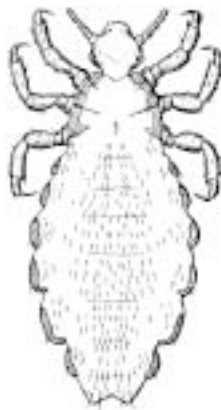

Adult Louse

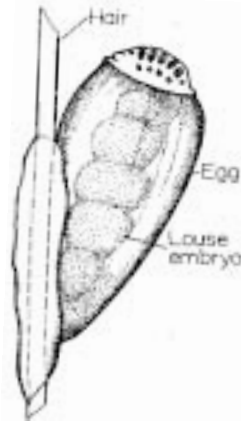

Nit

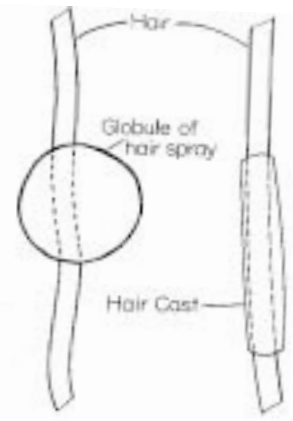

Hair Debris

They are attached with very strong glue and cannot be as easily removed as dandruff and other hair debris. There is no safe solvent for this glue.

The female lays 6-8 eggs/day. It takes 7 to 11 days for the eggs to hatch and another two weeks to develop into reproducing adults. Adults live for up to 30 days and spend their entire life on the human head. If they do move to other surfaces, they must return to the head within a few hours to survive.

In order to prevent multiplication and spread, the adults and the nits must be killed.

We encourage you to add a quick, weekly inspection for head lice to your regular personal hygiene routine for children between the ages of 6 and 10 (younger if the child is attending pre-school or day care). A magnifying glass can help you to see the nits.

---



---

## Recommendations for Treating Head Lice

In order to bring the current head lice problem under control, the following procedures are recommended:

1. Inspect your child's head. If you find lice or eggs (commonly called nits), continue reading. If you find no lice or nits, you don't need to do anything; however, it is a good idea to continue checking your child's head frequently.
  - (a) Separate the hair with a rat-tailed comb.
  - (b) Check all areas of your child's scalp, especially at the back of the neck and behind the ears—these seem to be the favorite spots for lice.
  - (c) Adult lice are found close to the scalp. Nits are attached to the hair 1/2 to 1 inch away from the scalp. Nits may be found farther out on the hair strands in long-standing cases. There may be anywhere from a few to several hundred nits in a child's hair.
  
2. If you find lice or nits, coat the hair with salad oil and comb out the lice and nits with a special metal lice comb. You can buy these combs in a pharmacy. Do not use the plastic combs provided with some pesticidal shampoos; they can allow nits and lice to slip through unnoticed (if you cannot find a metal lice comb, ask your pharmacist to order one from the Hogil Pharmaceutical Corp.).

Refer to the attached sheet entitled "How to Comb for Head Lice" for combing instructions.

You can get rid of lice just by combing. It is not necessary to use shampoos with pesticides. In fact, these shampoos are recommended only as a last resort in extreme cases.

- Do not use shampoos with pesticides on infants or children under 2 years, or on pregnant or nursing women.
- Do not use on anyone with open cuts, scratches, or head or neck inflammations.
- Do not use in the shower or bath; use over a basin or sink. Expose only the scalp to the pesticide.
- Never use lice shampoos to prevent lice infestations. Check the child's head first. If there are no lice, don't treat.
- Do not use extra shampoo or leave the shampoo on the hair for longer than the directions specify, and do not use on the eyebrows or allow any shampoo to get into the eyes.
- Store these products out of the reach of children, ideally in a locked cabinet.

OVER, PLEASE

---

- 
3. Comb, Comb, Comb! This is the only way to remove the nits. Repeat the combing every week until you find no more lice or nits. Be forewarned that if the child has very long or very curly hair this process will be time consuming. You may want to consider cutting the hair.
  4. Examine all members in the household. Treat them as above, if lice are found.
  5. Do not use the lice spray included in some of the lice shampoos. Lice cannot live in the environment and sprays unnecessarily expose everyone to pesticides.
  6. Wash bed linens and recently worn clothes in hot, soapy water in a washing machine and dry in a hot dryer. This does not have to be repeated daily. The washing is only necessary when you treat the child or when he/she is re-infested. Articles that cannot be washed can be vacuumed or placed in a plastic bag and sealed for 2 weeks. This will kill all lice and nits.
  7. Clean combs and brushes by soaking them in 1 teaspoon of ammonia and 2 cups of hot water or heating them in a pan of hot water for 5-10 minutes.
  8. If your time is limited, it is much more important to comb the child's hair than to spend time washing clothes and linens and vacuuming your house.

**REMEMBER:**

- It takes time to comb all the nits out of the hair, BUT, this must be done, and done frequently, until the hair is free of evidence of lice and nits.
  - Combing is an inconvenience, but remains a parent responsibility and only total parent cooperation and follow-through will stop the spread of lice.
  - You will probably find that your child actually enjoys the combing.
9. Check hair the morning following treatment to be sure it is nit-free before allowing your child to return to school.
  10. Until the lice epidemic has passed, school personnel will be examining children's heads each morning. Any child with nits or lice will not be allowed to attend school.
  11. If your child is re-infested, comb the hair again with the lice comb rather than applying pesticidal shampoo. Use these products only as a last resort.
  12. Instruct children and adults not to share combs, brushes, hats, and other articles of clothing that might be contaminated with strands of hair.
-

---

## How to Comb for Head Lice

NOTE: We do not recommend shampooing with a lice shampoo that contains a pesticide except in extreme cases and as a last resort.

### A. You will need:

- Salad oil.
- A special metal lice comb. These are available in drugstores (ask your pharmacist to order one if you cannot find a metal comb). Do not use the plastic combs that are included in some lice treatment packages. These are not effective.
- A wide bowl of water with a squirt of dishwashing detergent added. This water is used to kill nits (eggs) and lice combed from the head.
- A box of facial tissue.
- A strong lamp with a flexible arm that allows you to rotate it to direct the light wherever you are working. (If it is possible to do the combing in the daylight near a window, it will be much easier to see the adult lice and the nits.)
- If the hair is long, many large bobby pins or hair clips, to pin up sections of hair that have been combed.
- A large towel to place around the child's shoulders during combing.
- Two comfortable seats, one for the child and one for you. You want the child to be just below your eye level.
- Something entertaining for the child to do that does not require much physical activity, such as reading, drawing, playing with plastic clay, or watching videos.
- If the child has very long hair, which takes more time and tries the patience of the child, two people can work together on different parts of the head.

### B. Preparing the Hair

Cover the child's hair with salad oil (any kind will do). This will prevent the hair from tangling and make it very easy to use the lice comb. (The oil may also smother some of the young and adult lice, but you cannot count on it.) Oil has the advantage of not

drying out if the combing takes a long time. After you finish combing, shampoo the hair twice to remove the oil.

### C. The Combing

1. Seat the child so that his or her head is just slightly below your eye level.
2. Brush or comb the hair (use a large-toothed regular comb) to remove snarls.
3. Separate a mass of hair that is slightly wider than the width of your lice comb and about 1/2 to 3/4 inch in the other direction. Separating the hair into such small sections is important so that you can more easily see nits and adult lice.
4. Hold the mass of hair with one hand. With the other hand, hold the lice comb in a slanting position with the curved side of the teeth toward the head.
5. Insert the comb into the hair as close to the scalp as possible, since the eggs are first laid within 1/2 inch of the scalp. Pull the comb slowly through the hair several times.
6. Comb one section at a time and check each section to make sure it is clean, then pin it out of the way, curling it flat against the head.
7. Whenever you comb out nits or live lice, dunk the comb in the soapy water. Make sure the lice and nits are off the comb before you use it on the hair again. Frequently remove the hair and other debris from the comb with a tissue. When the tissue becomes soiled, place it in the bowl of soapy water. When the bowl is full, flush its contents down the toilet and refill the bowl with soapy water.
8. When all the hair has been combed, wash out the oil by shampooing twice.
9. Once the hair is completely dry, check the entire head for stray nits and remove those hairs individually with a pair of small, pointed scissors (like nail scissors).

### D. Cleaning up

1. Soak the lice comb in hot ammonia water (1 teaspoon of ammonia in two cups of hot water) for 15 minutes. Metal combs can also be boiled in

---

plain water for 15 minutes. A comb cleaned either way can be reused by many different children.

2. Scrub the teeth of the comb with a nail brush or an old toothbrush to remove debris. Remove dirt lodged between the teeth of the comb with dental floss or a small stiff brush.
3. Boil the towels for 10 minutes or wash them in a washing machine in hot, soapy water, and follow with a hot dryer.

Note: There is no safe solvent for the glue that the female louse uses to attach her eggs to the hair even though there are products that make such claims. Combing is the only sure way to remove nits from hair.

**WARNING:** If you must use a shampoo with a pesticide,

- Do not use on pregnant women or nursing mothers.
  - Do not use on children under 2 years.
  - Do not use on anyone with open cuts or scratches or with head or neck inflammations.
  - Do not use in a shower or bath where the pesticide can reach other parts of the body. Shampoo hair over a basin or sink.
  - Use gloves to do the shampooing.
  - Do not count on lice shampoos to kill nits. You must comb to get them out.
  - Never use any head lice shampoos preventively. Before you treat, make sure that live lice or eggs are present.
  - Return to combing if the lice shampoo is not working; it may mean product failure or that the lice have become resistant to the pesticide.
  - Store these shampoos out of the reach of children, ideally in a locked cabinet.
-

---

## Letter From School To Parents

Dear Parents,

There have been a few cases of head lice detected in your child's class. Attached is information on head lice and their treatment. Your child will not be allowed to return to school unless his/her head is free of nits (lice eggs).

Sincerely yours,

School Principal

---

---

# APPENDIX I

## INSPECTION CHECKLIST FOR DETECTING STRUCTURAL DECAY AND STRUCTURAL PEST DAMAGE

Check the following locations for structural decay and pest damage. Check both visually and by probing with a pointed tool, such as an ice pick. Look for signs of moisture, damaged wood, insect frass, and termite earthen tunnels and/or fecal pellets.

### **ROOF, OVERHANGS, GUTTERS, EAVES, TRIM, ATTIC**

#### **Roof Surface**

Check the roof for cracks, missing shingles, and other openings where moisture might enter. Shingles should extend 3/4 inch or more beyond the edge of the roof and should form a continuous drip line at the eave and end rafters, or at the rake boards that cover the end rafters.

Remove leaves from the roof surface, and replace any missing shingles. Install flashing or an aluminum drip edge under the first course of shingles to divert rainwater from the fascia board and walls of the building.

Be careful not to block eave vents. Install flashing; it should curl over the forward edge of the fascia board about 2 inches and then run about 6 inches beyond a vertical line drawn from the inside face of the wall studs.

Check for the formation of masses of ice on the roof near the gutters which can lead to water filtration and/or excessive condensation on interior attic walls.

#### **Gutters**

Check for poorly sloped, clogged, rotted, or leaking gutters that can lead to eave, overhang, or siding leaks and rots. Remove leaves and twigs that absorb moisture and cause rot. Flush gutters with a hose prior to the rainy season. Install downspout leaf strainers and gutter guards.

#### **Attics**

Extra effort is needed to inspect areas difficult to see or reach. Use a good light source and a probe. Search for rain seepage or decay around vent pipes, antennas, wall

top plates, skylights, and other vents.

#### **Eaves, Overhangs, and Fascia Boards**

Make sure there is at least 18 inches of overhang to allow proper water runoff. Extend short overhangs. Search for soft, tunneled, cracked, or exposed areas. Check areas where algae, moss, lichens, or discoloration occurs; these symptoms may indicate moisture problems and termites.

#### **Flashings**

Make sure areas around vents, chimneys, and dormers are flush and well sealed. Rusty or broken nails can cause problems in flashings. Aluminum or galvanized nails are required to prevent electrolysis (a chemical reaction between dissimilar metals that causes the nails to disintegrate). Seal nail head and flashing joints with marine-quality caulk or silicone (tar preparations are cheapest, but they crack after a few years in the sun).

#### **Damaged or discolored areas**

Search for exposed areas that are soft, tunneled, cracked, rotted, or blistered. Check for algae, moss, lichens, or discoloration, since these areas indicate potential openings for fungi and/or insects. Locate the sources of moisture and make the necessary repairs.

### **OUTSIDE WALLS**

#### **Rusty Nails**

Check for rusty nails or nail-staining, which indicates moisture within the wall and/or the use of non-galvanized nails. Replace nails with aluminum or galvanized nails or screws.

#### **Deteriorating Paint**

Look for signs of deteriorating paint such as loss of paint sheen and bubbling and peeling; scrape and sand the surface and repaint. If the wood seems soft, weak, or spongy, scrape out the spongy parts. If holes are smaller than 1/2 inch in diameter, fill them with caulk. Larger holes can be filled with epoxy wood-filler. If holes are very large, replace the wood.

#### **Building Siding that is Stained or Buckled**

---

Stained or buckled siding (with or without peeling paint) is a symptom of underlying moisture, rot, or insects. Check for moisture caused by splashing rain or lawn sprinklers. If possible, remove the source of the moisture and refinish or replace the damaged wood. In tropical, subtropical, or heavy rainfall areas, such as Hawaii or the Gulf Coast, pressure-treated siding is usually recommended. Consider using a more durable material, such as aluminum siding. Pressure-treated woods are treated with toxic materials and their use should be minimized.

### **Damaged Wood Junctions**

Moisture and insect problems often occur where wood pieces join or abut, particularly when there is shrinkage, splintering, or settling. Corners, edges of walls, roof-siding intersections, and siding-chimney contacts are particularly vulnerable. Apply water repellent and caulk to these joints, and monitor them regularly for building movement.

### **Weathering of Exposed Lumber/Beam Ends**

Check for expanded, split, or cracked lumber ends which provide access for moisture and insects. Even previously treated wood is subject to attack if the openings are deep enough. Caulk cracks and monitor for further developments.

### **Loose Stucco or Cracks in Stucco**

Search for cracks, especially stress cracks around windows and doors. These conditions can provide access to moisture, termites, and decay organisms. Caulk cracks. If they are large, consider replacing the old stucco.

### **Moisture Accumulation around Laundry Facilities, Especially Dryer Vents**

Check for signs of moisture accumulation around the vent. Modify the vent to direct exhaust air away from the building.

### **Moisture Associated with Pipes and Ducts**

Check for moisture where ducts pass through wooden parts of a building. Also check downspouts during heavy rains for leakage and proper drainage. Insulate ducts, install splash guards below downspouts, repair the spouts, and direct water away from buildings.

### **Moist Window Sills, Windows, or Doors**

Check for cracked sills and casings, and poorly fitted windows and doors. Badly fitted doors may indicate

warping of the door or its casing from excessive moisture or uneven settling. Moisture problems can alter door jambs. Warped and cracked sills and poorly fitted windows and doors allow water access which aids decay and provides initial insect habitat.

Caulk cracks and monitor for further development. Warped door thresholds and jambs may need replacement, and casings may need repair if the cracks are too large to caulk effectively.

## **FOUNDATION AND GRADE**

### **Soil Surface**

Make sure the soil surface slopes away from the school building in order to carry water away from the foundation. Seepage under the foundation will cause it to crack and settle. Add fill to direct the water away from the building but make sure there is at least 8 inches between the top of the fill and the sill. If clearance is small, consider installing foundation “gutters”. Install splash blocks and perforated pipe. Check their performance during rains or test the system with a hose. A sump pump can also be used to move water away from the foundation.

### **Low Foundation Walls and Footings Allowing Wood-to-Soil Contacts**

Check for wood in contact with the soil. Wood should be at least 8 inches, and preferably more, above the soil surface. Low foundation walls or footings often permit wooden structural members to come in contact with the soil, providing access for subterranean termites. Repair these areas or install subgrade concrete “gutters” where the building sills sit too close to ground level. Remove wood that comes in contact with the soil and replace it with concrete.

### **Foundation Cracks**

Check for cracks that allow decay organisms access to wood. Cracking may also indicate uneven settling. Monitor cracked walls for discoloration and seepage during rains. Termites use cracks to gain access to wood hidden from view. If the problem is serious, the foundation may need repair.

### **Brick Veneer or Stucco Applied to the Foundation**

Check the bond between the veneer or stucco and the foundation wall. If it is failing, moisture and termites may have a hidden entrance to wooden portions of the

---

building. Remove the loose covering and explore the extent of the decay.

## **CRAWL SPACE, BASEMENT, AND FOUNDATION**

Make sure enclosed crawl spaces are vented to allow moist air to escape. Milder climates are especially vulnerable to dry-rot fungus. In humid climates, the subfloor can be wet from condensation from interior air-conditioning. Shrubbery or other obstacles that block airflow through foundation vents cause air underneath the building to stay warm and moist—an ideal environment for termites.

Clean existing vents of dust, plants, and debris. Foundation vent openings should equal 2 ft<sup>2</sup> of opening for each 25 linear feet of outside wall. An opening should occur within 5 feet of each corner. Add more vents if needed. The top edge of the concrete under all vents should be at least 6 inches above the finished grade to allow sufficient ventilation. Vents located below grade may require wells to prevent surface water from entering subfloor and basement areas. Divert roof drainage away from vents.

### **Corners of the Building**

Check for moisture accumulation and stains at junctions of wood surfaces in these areas. Install additional cellar or crawl space vents.

### **Enclosed Areas**

Check for proper ventilation under staircases, porches, and other enclosed areas, since these are vulnerable to moisture accumulation. Look for decayed, discolored, or stained areas. Adjust or add venting.

### **Vapor Barriers**

Check for condensation on the subfloor and/or sill, which may indicate the need for vapor barriers on the subfloor and on the soil surface in the crawl space. Such barriers can be installed to reduce the moisture resulting from poor soil grading, unexpected seepage, or high rainfall.

Cover the crawl space soil surface with a 6-mil polyethylene vapor barrier. Use polyethylene, not roofing paper, which can rot. A slurry of concrete can be placed over the plastic to protect it from rodents. Where condensation continues, consider installing extra vents or electric-powered vents whose fans and openings are operated automatically. A sump pump can be installed to remove

standing water.

## **Wood-to-Stone or Wood-to-Concrete Contacts**

Check to see whether the wood is pressure-treated (look for perforation marks from the chemical injection on the surface of the wood). Replace untreated wood with rot-resistant or pressure-treated wood. Be sure sealing material is used between the wood and stone or concrete, and place a metal washer between posts and footings.

## **Leaky Pipes or Faucets**

Even small leaks keep the wood or soil underneath continuously moist, thereby setting up ideal conditions for termites. Areas where rain splashes on walls should be protected with rain guards. Do not allow sprinklers to spray the side of the building. Fix all leaks, and change irrigation practices where necessary.

## **Water- or Space-Heating Units**

Check to see whether the heating unit is insulated. If the soil near the flame is kept warm throughout the year due to lack of insulation, microbial and insect development will be accelerated. Insulate the heater and cover the soil with concrete.

## **Paper Collars around Pipes**

Since paper is almost pure cellulose, it is extremely attractive to termites and should be removed and replaced with other insulating materials not capable of being eaten by termites.

## **Miscellaneous Openings**

Meter boxes, bathroom inspection doors, pet doors or openings, milk delivery doors, and air exhaust vents should be checked for water access, cracks, termite pellets, and soft areas.

# **EXTERNAL AREAS**

## **Porches**

Check for wooden steps touching the soil, and inspect for possible decay or termite access. The porch surface must slope away from the building to carry rain away quickly. If the porch does not slope away from the building, check siding for moisture and termites. Tongue-and-groove flooring is a water trap. If there is a space between the porch and the building, check for drainage problems.

Caulk and repair cracks. Fill spaces between tongue-and-



---

groove floorboards with caulk or resurface and refinish with wood-sealing compounds and appropriate paint. Another floor can be placed over the first.

### **Earth-Filled Porches**

Soil should be at least 8 inches, (optimally 12 to 18 inches) below the level of any wooden members. Remove the excess soil where possible, regrade to enhance drainage and redesign the porch to eliminate earth/wood contact.

### **Planter Boxes**

Check planter boxes that are built against the building. If they are in direct contact with the building, they allow direct termite access to unprotected veneer, siding, or cracked stucco. One remedy is adding 2 to 3 inches of protective concrete wall between the planter and the building. An air space several inches wide must separate the planter wall from the building and must be kept free of dirt or other debris.

### **Trellises and Fences**

Check for wooden portions of the trellis that touch the soil and are connected to the building, since they provide a direct link to the building for wood-rot and termites. Check fence stringers and posts for decay. Cut off the decay and install a concrete footing for trellises and fence posts. Replace decayed stringers and leave a small gap between the stringers to allow air circulation. Separate wood and concrete with metal washers.

### **Wooden Forms around Drains**

These are sometimes left in place after the concrete foundation is poured and provide termites with access routes to inner walls. Areas and joints around pipes rising from slabs should be sealed with tar or other adhesive to prevent water and termite access. Caulk the holes and monitor them for decay and excess moisture.

### **Gate Posts, Fence Tie-ins, Abutments and Columns**

Inspect these for weakness and rot especially around areas adjacent to the soil. Exposed areas can provide cracks for termite invasion. If wooden posts go through concrete into the soil below, check the posts for evidence of termite attack. The bottoms of these posts should be cut and replaced with a concrete footing. Cut

post tops at an angle to promote runoff and prevent water from penetrating the vulnerable end grain.

### **Balconies and Landings**

Surfaces should be sloped away from the building. Check junction of floor and siding for moisture and insects.

### **Wood Debris under and around Buildings**

Pieces of wood, particularly partially buried tree roots or construction lumber, can help support a termite colony until the population grows large enough to attack the building itself. Since cardboard boxes are very attractive to termites, they should be removed from crawl spaces or basements with earthen floors.

## **INTERIOR LOCATIONS**

Areas with water stains or mold growth indicate excessive moisture and should be analyzed for corrective action. Pay special attention to areas listed below.

### **Kitchen Pipes**

Look for condensation and leaks, especially where pipes enter walls. Repair leaks and insulate pipes where condensation is excessive.

### **Counter Areas**

Check around and below sink surfaces for moisture and decay. Caulk or otherwise protect wall surfaces from moisture. Subsurface areas damaged by water leaking from above may be tolerated if the surface leaks are repaired.

### **Exhaust Vents**

Check for moisture leaks from outside. Repair with caulk or water-resistant sealing material, or replace the vent and the rotted wood around it. Use extra flashing to fill the gap.

### **Toilets**

Check the integrity of the floor around each toilet base by thumping lightly with a hammer. Check the wax seal for leakage at the floor/toilet pedestal intersection. Check the cellar or crawl space beneath the toilets to see whether the leakage has caused damage. Replace the wax seal if necessary and repair the surrounding water damage.

---

## **Showers and Sinks**

Check all sinks and showers for a sound caulk seal. Look for splash-over on the floors from inadequate water barriers or user carelessness. If moisture is visible from crawl spaces, it may indicate a crack in the floor or in drainage pipes. If moisture is visible in the ceiling, it may indicate cracks in the delivery pipes.

Repair or replace flooring materials, pipes, drains, or sink basins if necessary. Sealing compounds may be useful when leaks are relatively recent and small, especially if termites have not been found; however, regular monitoring is necessary if sealing materials are used.

## **Tile Walls**

Check for mildew stains. Make sure the grout in tile walls has a silicone coating to prevent water penetration. Clean the walls regularly to remove mildew and improve ventilation.

## **Ceilings**

Check for blistered areas, since these can indicate moisture leaks in the area above or inadequate installation of a vapor barrier. Repair leaks and faulty vapor barriers.

## **Windows**

Check for moisture accumulation and/or water stains on window frames and walls. Search for evidence of decay or insect attack next to glass areas where condensation accumulates, at edges where moldings meet walls and casings, and in window channels and door jams. Gaps between window and door casings may be avenues for

hidden moisture and insect access. Check interior walls beneath windows, especially if they are regularly wetted by garden sprinklers.

Open windows when feasible to improve air circulation. Install double- or triple-glazed windows when replacement is necessary. Use aluminum frames if wooden frames are decaying. Adjust or move sprinklers so water does not hit windows.

## **Closets**

Check coat and storage closets for dampness. A light bulb left burning continuously in a damp closet will often generate enough heat to dry it out, but make sure the bulb is far enough away from stored materials to avoid creating a fire hazard. Containers of highly absorbent silica gel, activated alumina, or calcium chloride also remove moisture from the air in enclosed spaces. These agents should be placed out-of-reach to avoid accidental exposures. Avoid use of silica gel where children may tamper with the containers. These chemicals can be reused after drying them in the oven. Small exhaust fans can also improve closet ventilation.

## **Floors**

Sagging or buckling floors can indicate shrinkage or rot from excessive condensation or water leaks. Gaps between floor and baseboards can indicate wood damage from insects, fungi, or water-triggered swelling and shrinkage.

